



Car Key Shells

Vers. 3.0

**EN**

- III** Index
- V** Technical Information
- VII** Glossary

- 1** Car Key Shells
- 65** General Index

IT

- III** Index
- V** Informazioni Tecniche
- VII** Terminologia

- 1** Gusci Chiavi Auto
- 65** Indice Generale

DE

- III** Index
- V** Technische Auskünfte
- VII** Terminologie

- 1** Fahrzeugleergehäuse
- 65** Generalverzeichnis

FR

- III** Index
- V** Informations Techniques
- VII** Référence Silca

- 1** Coques de Télécommandes
- 65** Index Général

ES

- III** Index
- V** Informaciones Técnicas
- VII** Terminología

- 1** Carcasas para Llaves de Vehículo
- 65** Índice General

PT

- III** Index
- V** Informações Técnicas
- VII** Terminologia

- 1** Car Key Shells
- 65** Índice Geral

NL

- III** Index
- V** Technische Informatie
- VII** Woordenlijst

- 1** Autosleutel Shells
- 65** Algemene Index



EN - The range of Silca Car Key Shells is the ideal solution for replacing damaged or worn plastic or mechanical key parts. The Silca shell can then be combined with the original electronics to create a 'new' car key. The comprehensive range covers the most popular car makes and models in circulation.

IT - La linea Car Key Shells Silca è la soluzione ideale per tutte le situazioni in cui la chiave originale è inutilizzabile causa danneggiamento della componente plastica, meccanica oppure semplicemente usurata dal tempo. La componente elettronica viene invece riutilizzata inserendola nel nuovo guscio chiave dando nuova vita alla chiave originale. La gamma Car Key Shells Silca copre i modelli auto più popolari in circolazione.

ES - La gama de Carcasas Silca para llaves de vehículo es la solución ideal para reemplazar las carcasas dañadas, desgastadas o con las partes mecánicas dañadas. La carcasa Silca puede montarse con el resto de componentes no dañados de la llave original, para crear una llave en el vehículo con el aspecto y la funcionalidad de una llave nueva. Las Carcasas Silca abarcan las marcas y modelos más populares en circulación.

DE - Der Umfang der Silca Fahrzeugleergehäuse ist die ideale Lösung, um defekte oder abgenutzte Plastik- oder mechanische Schlüsselteile zu ersetzen. Das Silca Leergehäuse wird in Kombination mit den elektronischen Teilen des Originalschlüssels zu einem "neuen" Fahrzeugschlüssel. Das umfassende Sortiment deckt die gängigsten Fahrzeughersteller und Fahrzeugmodelle ab, die im Umlauf sind.

PT - A linha Car Key Shells Silca é a solução ideal para todas as situações em que a chave original não pode ser utilizada devido a danos na componente plástica, mecânica ou simplesmente porque gasta pelo uso. A componente eletrónica, ao contrário, é utilizada novamente inserindo-a no novo invólucro da chave dando nova vida à chave original. A gama Car Key Shells Silca abrange os modelos de veículo mais comuns em circulação.

FR - La gamme Silca de coques vides pour télécommandes de voiture est la solution idéale pour remplacer les pièces en plastique ou mécaniques endommagées ou usées. La coque Silca peut ensuite être combinée avec l'électronique d'origine pour créer une «nouvelle» clé de voiture. La gamme complète couvre les marques et les modèles de voitures en circulation les plus populaires.

NL - De Silca productenlijn Autosleutel Shells is de ideale oplossing voor alle situaties waarbij de originele sleutel niet meer kan worden gebruikt omdat het plastic of mechanisch onderdeel beschadigd of versleten is. De elektronische component wordt opnieuw gebruikt en in een nieuwe sleutelmantel geplaatst, zodat het originele sleutelblad kan worden gerecupereerd. Het assortiment Car Key Shells van Silca bevat de meest frequente automodellen op de markt.



KEY SHELLS RANGE – THE CATALOGUE

EN. Keep updated and Discover Silca Key Shells range updates visiting thecatalogue.silca.biz

IT - Rimani aggiornato e scopri le novità della gamma Silca Key Shells consultando thecatalogue.silca.biz

DE - Entdecken Sie die Aktualisierungen der Schlüsselpalette Silca Key Shells auf unseren Websites www.silca.biz und thecatalogue.silca.biz

FR - Découvrez les mises à jour de notre gamme de clés Silca Key Shells directement sur notre site www.silca.biz et thecatalogue.silca.biz.

ES - Descubra las actualizaciones de la gama llaves Silca Key Shells visitando www.silca.biz y thecatalogue.silca.biz

PT - Descubra as atualizações da gama de chaves Silca Key Shells através dos sítios www.silca.biz e thecatalogue.silca.biz.

NL - Blijf up-to-date en ontdek wat nieuw is in Silca Key Shells bereik door thecatalogue.silca.biz te bezoeken.

CAR KEY SHELL PACKAGE

Practical one-piece package for optimized stock management and hook display./Confezione singola sigillata per una gestione ottimale del magazzino e di pareti espositore./ Versiegelte Einzelverpackung zur optimalen Verwaltung im Lager und Präsentation auf Verkaufsausstellern./ Emballage individuel pratique et optimisé pour les stocks et les présentoirs muraux./Práctico envase individual ideal para almacenar o colgar en expositores de ganchos / Embalagem simples selada para a melhor gestão do depósito ou das paredes do expositor./ Praktisch enkel gesloten pakket voor optimaal magazijnbeheer en displaymuren

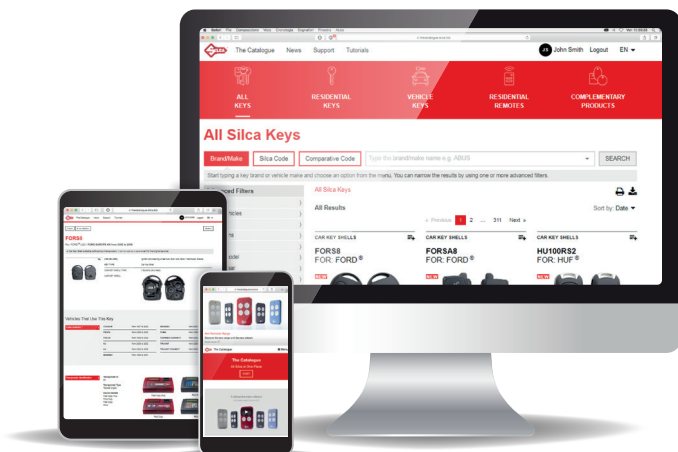



Glossary

- | | | |
|---|---|---|
| <p>1 Vehicle brand / Marca veicolo / Fahrzeuge-Marke / Marque véhicule / Marca vehículo / Marca do veículo / Automerk</p> | <p>5 Outer side / Lato Esterno / Außenseite / Côté Externe / Lado Externo / Lado externo / Buitenzijde</p> | <p>9 Unlock / Apri / Öffnen / Ouverture / Abrir / Abri / Ontgrendelen</p> |
| <p>2 Silca reference / Referenza Silca / Silca-Artikel / Référence Silca / Artículo Silca / Artigo Silca / Silca artikel</p> | <p>6 Inner side / Lato Interno / Innenseite / Côté Interne / Lado Interno / Lado interno / Binnenzijde</p> | <p>10 Battery on circuit / Batteria integrata nel circuito / In den Schaltkreis integrierte Batterie / Batterie intégrée dans le circuit / Bateria integrada en el circuito / Bateria integrada no circuito / Batterij geïntegreerd in het circuit</p> |
| <p>3 Photo complete key / Foto Chiave Completa / Foto kompletter Schlüssel / Photo clé complète / Foto Llave Completa / Fotografia chave completa / Foto volledige sleutel</p> | <p>7 Buttons / Pulsanti / Taste / Boutons / Botones / Botões / Aantal knoppen</p> | <p>11 "Silca TE" Compatibility / Compatibilità "Silca TE" / "Silca TE" Kompatibilität / Compatibilité "Silca TE" / Compatibilidad "Silca TE" / Compatibilidade "Silca TE" / Compatibel met "Silca TE"</p> |
| <p>4 Blade / Profilo / Profil / Profil / Perfil / Perfil / Profiel</p> | <p>8 Lock / Chiudi / Schließen / Fermeture / Cerrar / Fechar / Vergrendelen</p> | <p>12 Silca Barcode  Silca Barcode Ordering</p> |



Buttons / Pulsanti / Tasten / Boutons / Botones / Botões / Aantal knoppen



1 Button / 1 Pulsante / 1 Taste / 1 Bouton / 1 Botones / 1 Botões / 1 Knop



2 Buttons / 2 Pulsanti / 2 Tasten / 2 Boutons / 2 Botones / 2 Botões / 2 Knoppen



3 Buttons / 3 Pulsanti / 3 Tasten / 3 Boutons / 3 Botones / 3 Botões / 3 Knoppen



4 Buttons / 4 Pulsanti / 4 Tasten / 4 Boutons / 4 Botones / 4 Botões / 4 Knoppen



Boot / Bagagliaio / Kofferraum / Coffre / Maletero / Bagageira / Koffer



Light / Luce / Licht / Phares / Faro / Farol / Licht



Red panic button / Bottone rosso antipánico / Bouton rouge anti panique / Roter Panikknopf / Botòn rojo antipánico / Botão vermelho antipânico / Rode antipaniektoets



Sliding Door – Left|Right / Porta Scorrevole – Sinistra|Destra / Links Schiebende Fahrzeugtür - Links|Recht / Porte Coulissante du Véhicule - gauche|droit / Puerta Vehículo - deslizante|derecho / Porta de correr - esquerda|direita / Schuifdeur - Linker|Rechts



Lock / Chiudi / Schließen / Fermeture / Cerrar / Fechar / Vergrendelen



Lock/Unlock / Chiudi e Apri / Schließen und Öffnen / Fermeture et Ouverture / Abrir y Cerrar / Abrir e Fechar / Vergrendelen en Ontgrendelen



Unlock / Apri / Öffnen / Ouverture / Abrir / Abrir / Ontgrendelen

Transponder



With Transponder Holder / Con porta transponder / Mit Transponderhalter / Avec support de transpondeur / Con alojamiento para transponder / Com suporte do transponder / Met transponderhouder.



Without Transponder Holder / Senza porta transponder / Ohne Transponderhalter / Sans support de transpondeur / Sin alojamiento para transponder / Sem suporte do transponder / Zonder transponderhouder

Battery / Batteria / Batterie / Batterie / Batería / Bateria / Batterie



Battery inside Case / Batteria integrata nel guscio / In die Schale integrierte Batterie / Batterie intégrée dans la coque / Batería integrada en la carcasa / Bateria integrada no invólucro / In die Schale integrierte Batterie



Battery on circuit / Batteria integrata nel circuito / In den Schaltkreis integrierte Batterie / Batterie intégrée dans le circuit / Batería integrada en el circuito / Bateria integrada no circuito / Batterij geïntegreerd in het circuit



Flip Key



“Silca TE” Compatibility / Compatibilità “Silca TE” / “Silca TE” Kompatibilität / Compatibilité “Silca TE” / Compatibilidad “Silca TE” / Compatibilidade “Silca TE” / Compatibel met “Silca TE”



Flip Key / Chiave a scatto / Klappschlüssel / Clé Flip / Llave Plegable / Chave Flip / Klapsleutel

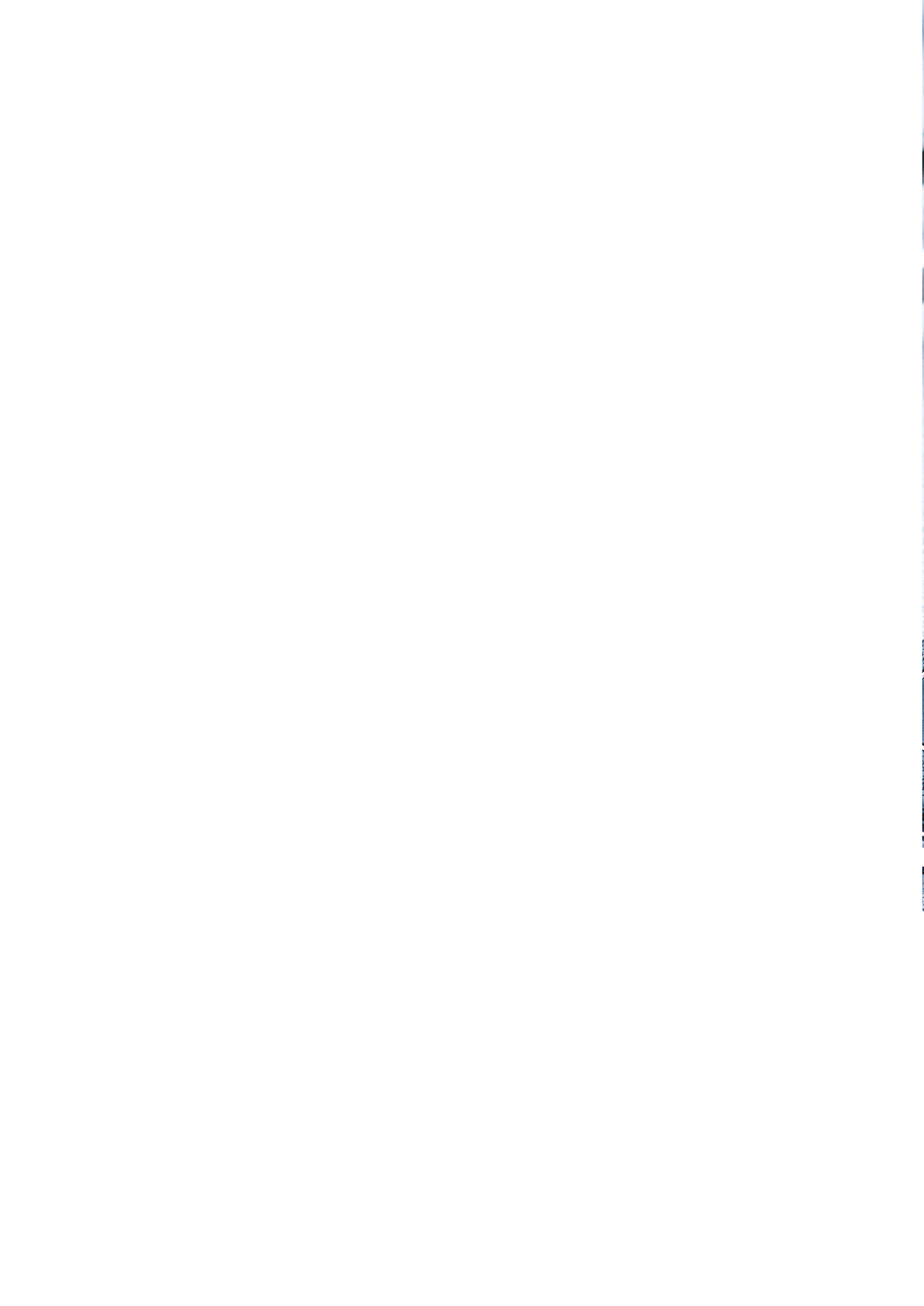



Car Key Shells

Gusci Chiavi Auto

Fahrzeugleergehäuse

Coques de Télécommandes

Carcasas para Llaves de Vehiculo

Car Key Shells

Autosleutel Shells

Car Key Shells



FOR: ABARTH®



SIP22CRS8



SIP22RS8

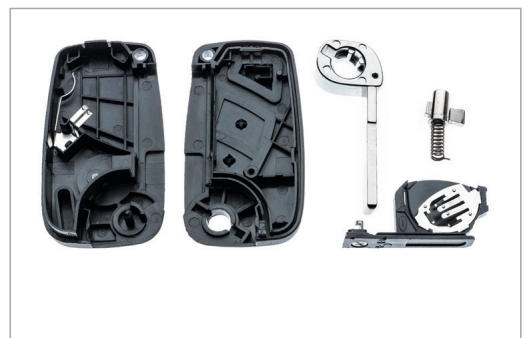

FOR: ALFA ROMEO®



SIP22BRS8

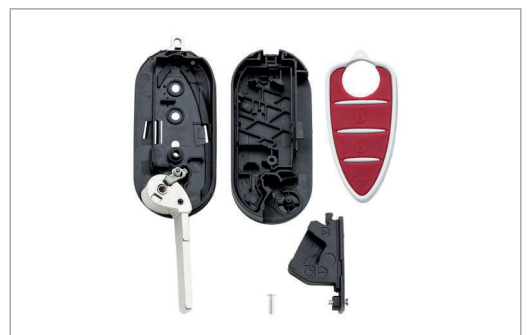



Car Key Shells

FOR: AUDI®



8 0 0 3 7 3 7 9 1 3 7 3 7

HU66APRS



8 0 0 3 7 3 7 8 6 3 7 8 0

HU66ARS8



8 0 0 3 7 3 7 8 5 5 6 9 3

HURSB2



FOR: AUDI®



HURSB8

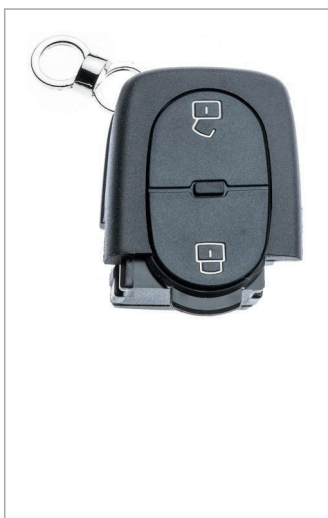

HURSC2

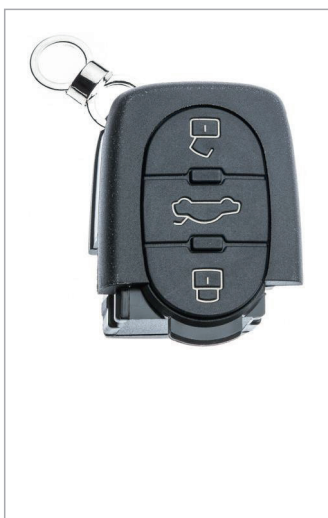

HURSC8



FOR: BMW®

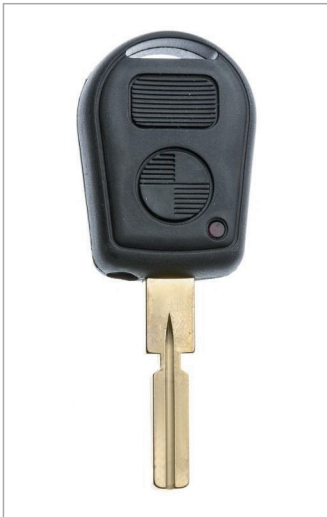

HU58RS2N

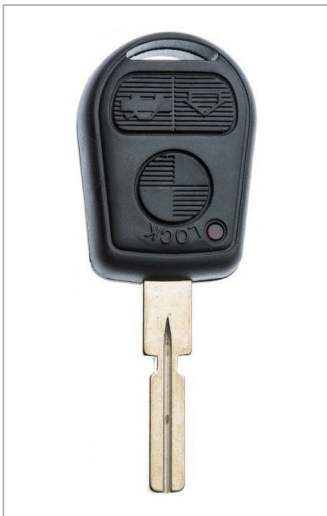

HU58RS8N



HU92RRS2N



Car Key Shells



FOR: BMW®

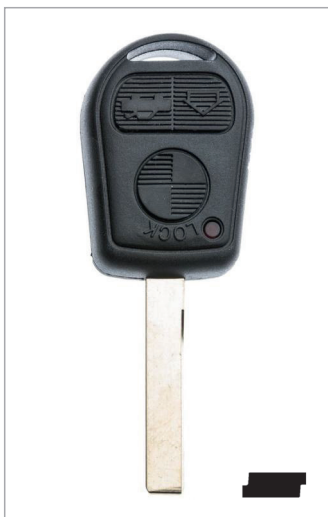

HU92RRS8N



FOR: CHEVROLET® SOUTH AMERICA



HURSH2N



FOR: CHRYSLER®



CY24RS2

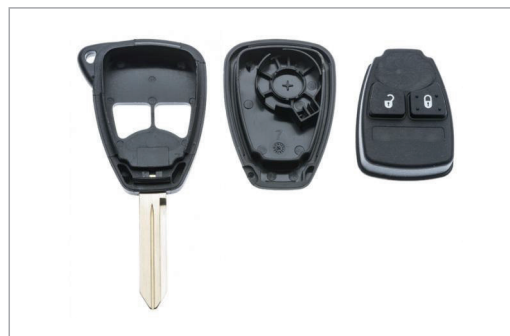

FOR: CHRYSLER®



CY24RS8



SIP22CRS8



FOR: CITROËN®



HU83ARS2



FOR: CITROËN®

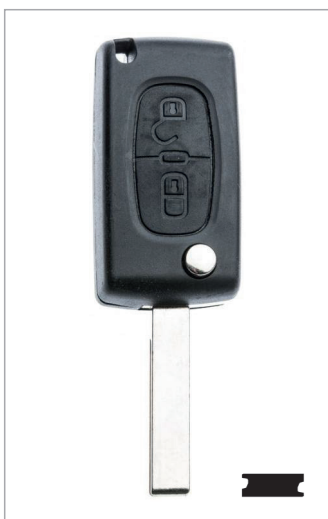

HU83ARS2N



HU83BRS8



HU83BRS8N





Car Key Shells

FOR: CITROËN®



HU83CRS7



HU83CRS7N



HU83RS2



Car Key Shells



FOR: CITROËN®



SIP22CRS8



SX9ARS2

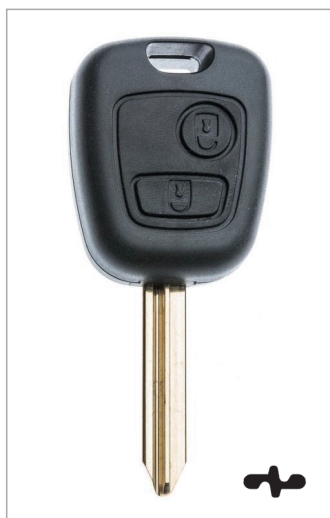
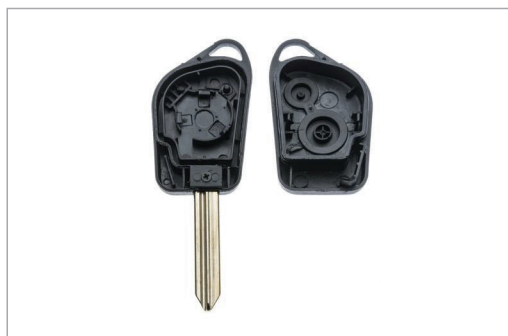

SX9RS2



FOR: CITROËN®



SXRSA2



VA2ARS2N



VA2BRS2



FOR: CITROËN®



VA2BRS8

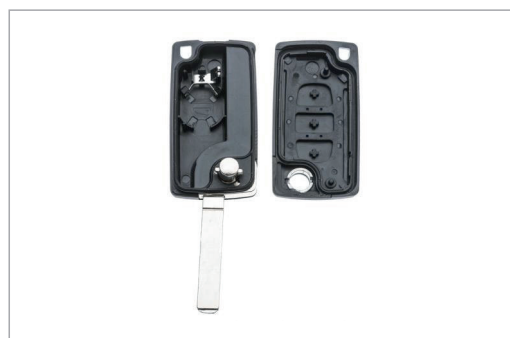

VA2BRS8N



VA2RS2





Car Key Shells

FOR: FIAT®



GT15RARS1



GT15RRS1



HU83RS2



FOR: FIAT®



SIP22ARS1



SIP22CRS8



SIP22FRS8



FOR: FIAT®



SIP22RS8



FOR: FORD EUROPE®



FORS8



FORSA8



Car Key Shells



FOR: FORD EUROPE®



HU101ARS8



SIP22ERS8



FOR: HOLDEN®



HURSH2N



FOR: HONDA®



HON66RS3



HON66RS4



HON66RS5



Car Key Shells



FOR: HONDA®



HON66RS6



FOR: HONDA® USA



HON66RS1

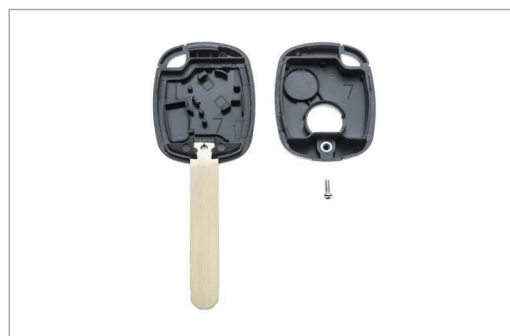

HON66RS2



FOR: HYUNDAI®

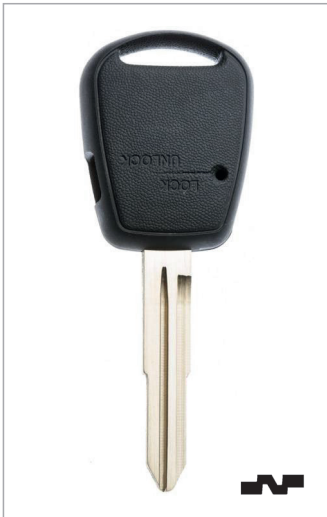

HYN12RS1



KIA8RS8



FOR: IVECO®



GT10RS1



Car Key Shells



FOR: IVECO®



SIP22CRS8

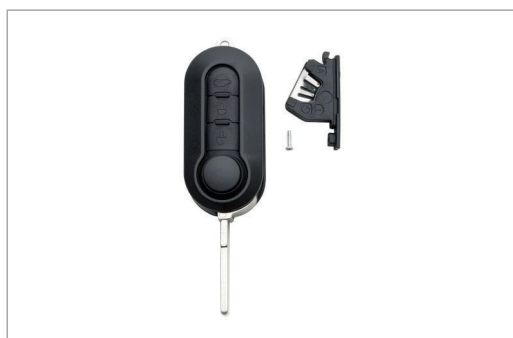

FOR: LANCIA®



HU83BRS8

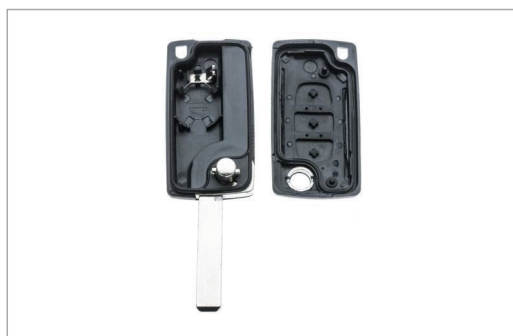

HU83BRS8N





Car Key Shells

FOR: LANCIA®



HU83CRS7



HU83CRS7N



SIP22CRS8



FOR: LANCIA®



SIP22RS8



FOR: LEXUS®



TOY40BRS2



TOY40BRS8





Car Key Shells

FOR: LEXUS®



TOY48BRS2



TOY48BRS8



FOR: MARUTI SUZUKI®



HU133RDRS1



Car Key Shells



FOR: MARUTI SUZUKI®



SZ11RDRS1



FOR: MERCEDES®



HURS5

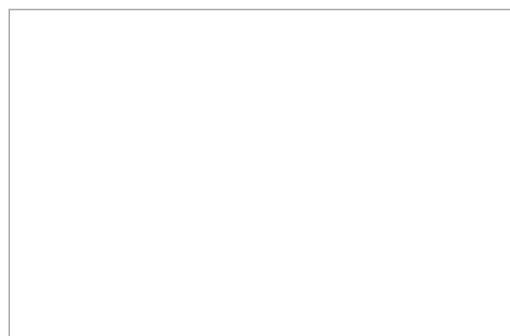

FOR: MINI®



HU200RS2





Car Key Shells

FOR: MITSUBISHI®



MIT8RS2

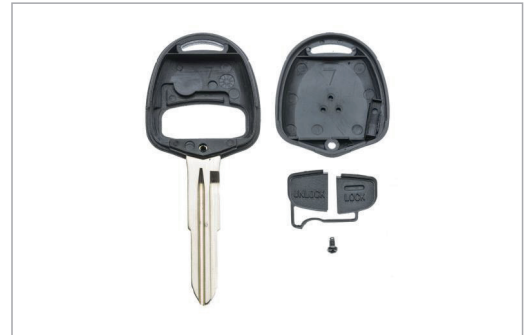

FOR: NISSAN®



NSN14RS2



NSN14RS8



Car Key Shells



FOR: NISSAN®



NSNRS2

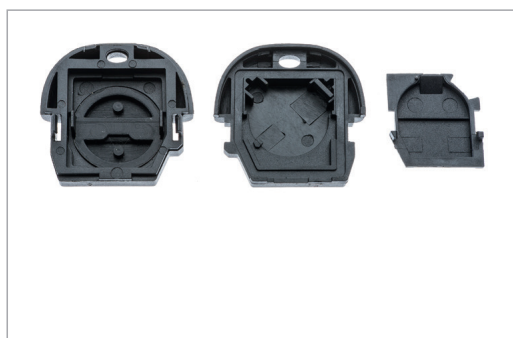

FOR: NISSAN® (TRUCKS)



NSNRS2

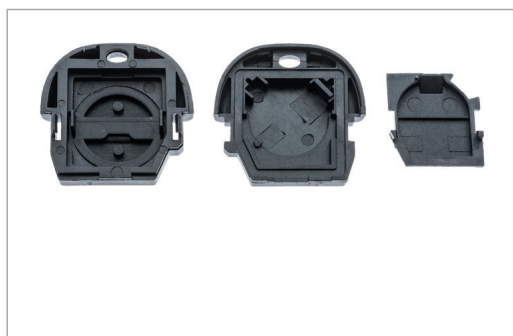

FOR: OPEL® - VAUXHALL®



HU100RS2

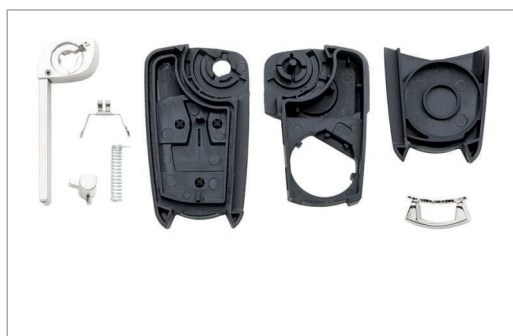

FOR: OPEL® - VAUXHALL®



HU100RS8



HU87RS2



HURSG2N



FOR: OPEL® - VAUXHALL®



HURSG8N



HURSH2N

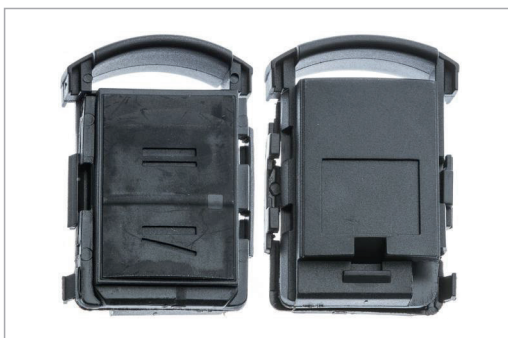

NERS5





Car Key Shells

FOR: OPEL® - VAUXHALL®



VACRS2



VACRSA2



FOR: PEUGEOT®



HU83ARS2



FOR: PEUGEOT®

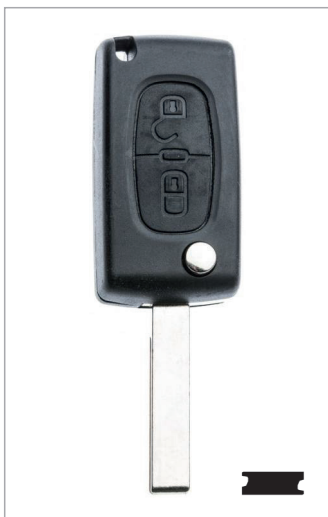

HU83ARS2N



HU83BRS8



HU83BRS8N





Car Key Shells

FOR: PEUGEOT®



HU83CRS7



HU83CRS7N



HU83RS2



FOR: PEUGEOT®

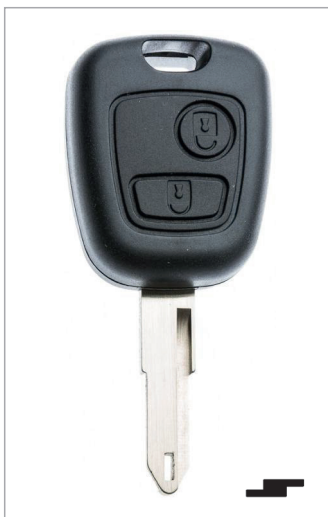

NE73RS2



NE78ARS2N



NE78BRS8



FOR: PEUGEOT®



NE78BRS8N



NE78RS2N



SIP22CRS8



Car Key Shells



FOR: PEUGEOT®

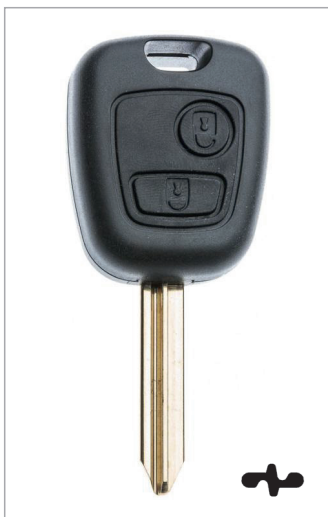

SX9RS2

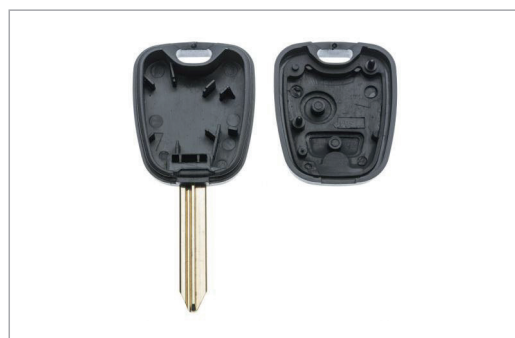

VA2ARS2N



VA2BRS2





Car Key Shells

FOR: PEUGEOT®



VA2BRS8



VA2BRS8N



VA2CRS7



Car Key Shells



FOR: PEUGEOT®

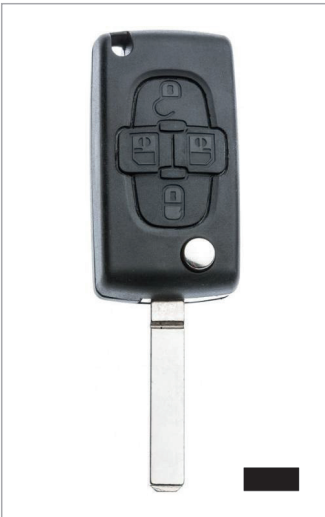

VA2CRS7N



VA2RS2



FOR: PORSCHE®



HU66RS1





Car Key Shells

FOR: PORSCHE®



HU66RS2



HU66RS8



FOR: RENAULT®



NE73ARS1



FOR: RENAULT®



NE73BRS1



NERS5



NERSD1N



FOR: RENAULT®



VA150RS8

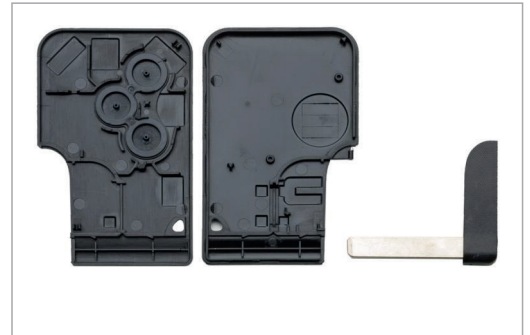

VA2ERS2



VA2ERS8



FOR: RENAULT®

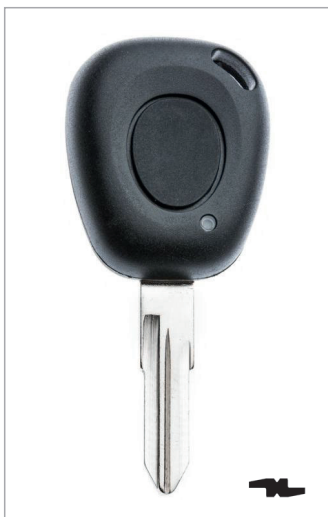

VAC102ARS1



VAC102B1N



VACRS2





Car Key Shells

FOR: RENAULT®



VACRSA2



FOR: RENAULT® - DACIA®



VACRSA2



FOR: SEAT®



HU66BRS8

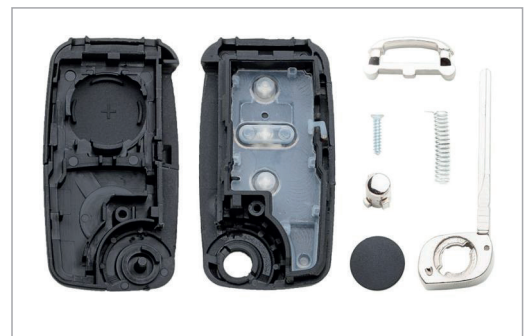

Car Key Shells



FOR: SEAT®



HU66PRS



HURSA2



HURSA8



FOR: SKODA®



HU66BRS8

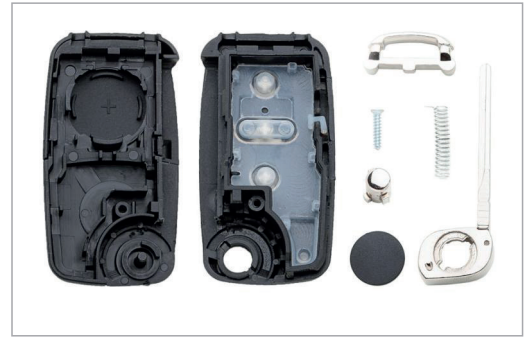

HU66PRS



HURSA2



Car Key Shells



FOR: SKODA®



HURSA8



FOR: SMART®



VA2DRS10



VA2DRS8



FOR: SMART®



YM23RS1



YM23RS8



FOR: SUBARU®



HU87RS2



Car Key Shells



FOR: SUBARU®



TOY43CRS7N



FOR: SUZUKI®



HU87RS2



SZ11RRS2





Car Key Shells

FOR: TOYOTA®



TOY40BRS2



TOY40BRS8



TOY41RBR8



FOR: TOYOTA®



TOY41RRS2



TOY43ARS2

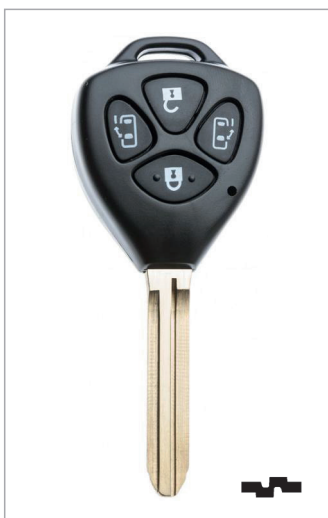
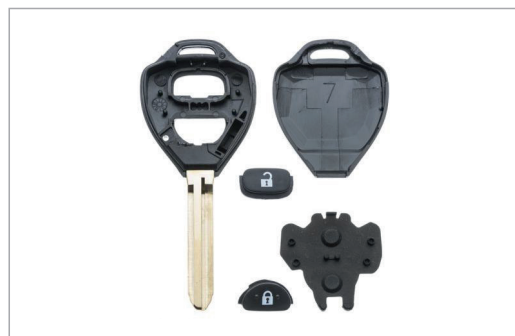

TOY43ARS7



FOR: TOYOTA®



TOY43BRS2



TOY43BRS8



TOY43CRS2N



Car Key Shells



FOR: TOYOTA®



TOY43CRS7N



TOY47BRS2



TOY47BRS8

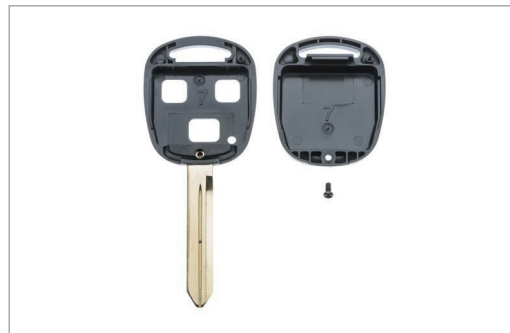

FOR: TOYOTA®



TOY48BRS2



TOY48BRS8



TOYRSE2



Car Key Shells



FOR: TOYOTA®



VA2RS2



FOR: TOYOTA® JAPAN



TOY40BRS2



TOY40BRS8





Car Key Shells

FOR: TOYOTA® JAPAN



TOY41RBR8

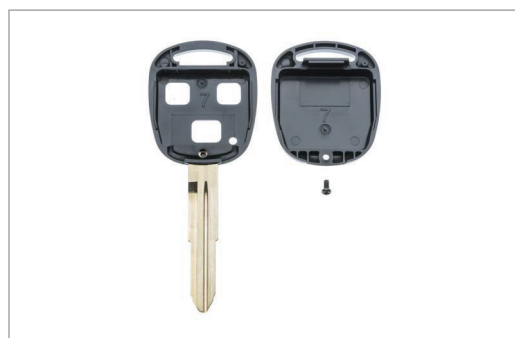

TOY41RRS2



TOY43BRS2



FOR: TOYOTA® JAPAN



TOY43BRS8

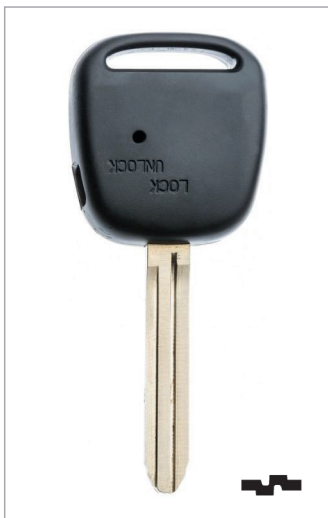

TOY43RS1

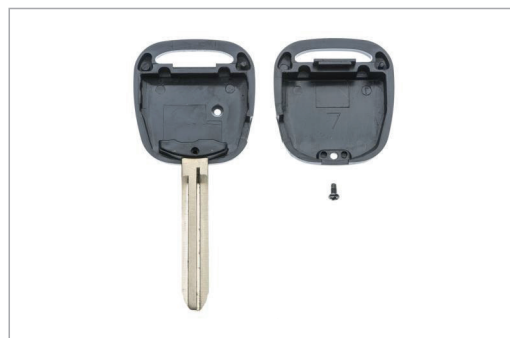

TOY43RS2



FOR: TOYOTA® JAPAN



TOY48ARS8



TOY48BRS2



TOY48BRS8



Car Key Shells



FOR: TOYOTA® JAPAN



TOYRSE2



FOR: TOYOTA® USA



TOY41RBR8

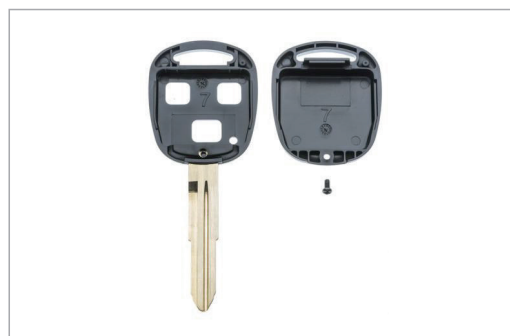

TOY41RRS2



FOR: TOYOTA® USA



TOY43ARS10

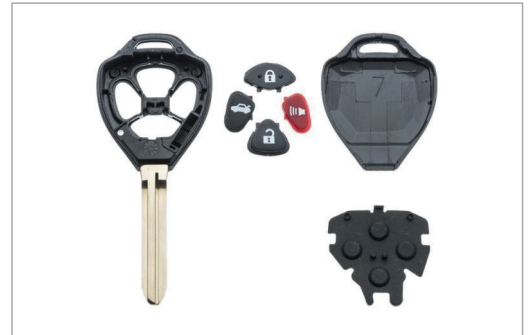

TOY43ARS2



TOY43ARS7

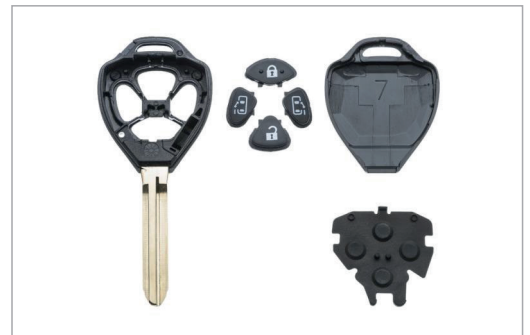

FOR: TOYOTA® USA



TOY43ARS8



TOY43ARS9

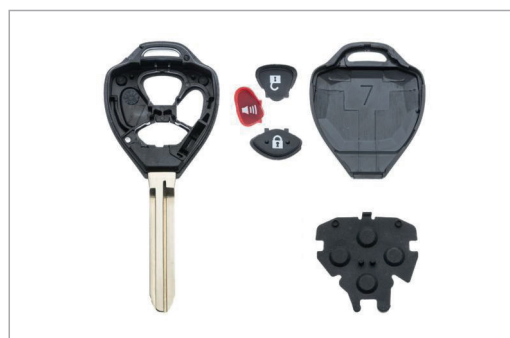
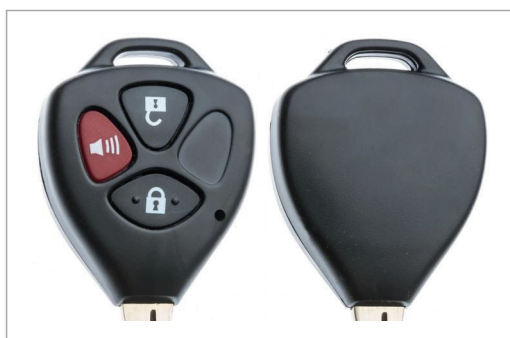

TOY43BRS2





Car Key Shells

FOR: TOYOTA® USA



TOY43BRS8



FOR: VOLKSWAGEN®



HU66APRS



HU66BRS8

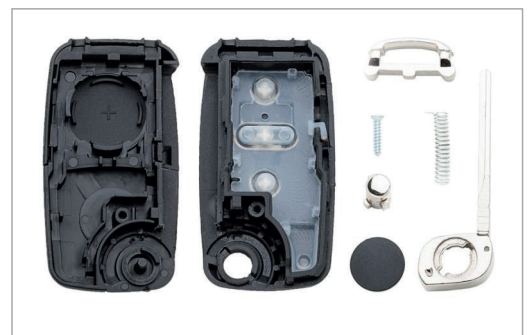

Car Key Shells



FOR: VOLKSWAGEN®



HU66PRS



HURSA2



HURSA8





Car Key Shells

FOR: VOLKSWAGEN®

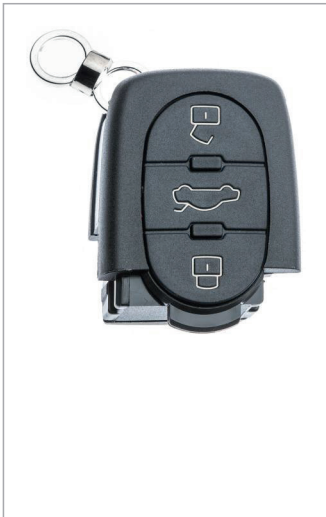

HURSB8



FOR: SMART®

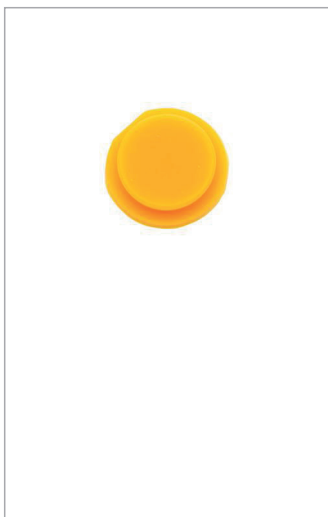

YMRS1

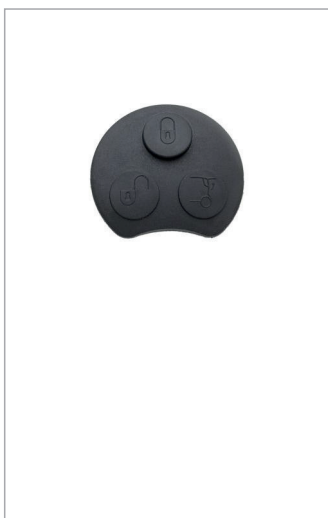

YMRS8



FOR: TOYOTA®



TOYRS8





Rubber Pads

FOR: TOYOTA® JAPAN



TOYRS8



8 0 0 3 7 3 7 8 3 3 6 3 9

FOR: TOYOTA® USA



TOYRS8



8 0 0 3 7 3 7 8 3 3 6 3 9



General index

Indice Generale

Generalverzeichnis

Index Général

Indice General

Índice Geral

Algemene Index

FOR: ABARTH®

SIP22CRS8 3 BUTTONS 1

See also: CHRYSLER®, CITROËN®, FIAT®, IVECO®, LANCIA®, PEUGEOT®

MODEL	FROM	TO	TRP TYPE	COMPL. KEYS*
500	2008		PH / CR2	
PUNTO EVO	2010	2012	PH / CR2	
PUNTO	2012		PH / CR2	

SIP22RS8 3 BUTTONS 1

See also: FIAT®, LANCIA®

MODEL	FROM	TO	TRP TYPE	COMPL. KEYS*
GRANDE PUNTO	2007	2010	PH / CR2	

FOR: ALFA ROMEO®

SIP22BRS8 3 BUTTONS 1

MODEL	FROM	TO	TRP TYPE	COMPL. KEYS*
GIULIETTA	2010		PH / CR2	
MiTo	2008		PH / CR2	

FOR: AUDI®

HU66APRS 2

See also: VOLKSWAGEN®

MODEL	FROM	TO	TRP TYPE	COMPL. KEYS*
A2	2000	2005	MEG / CR	
A3	1998	2005	MEG / CR	
A4	1999	2004	MEG / CR	
A6	1997	2004	MEG / CR	
A6	2004	2006	MEG / CR	
A8	1997	2004	MEG / CR	
TT	1998	2006	MEG / CR	

HU66ARS8 3 BUTTONS 2

MODEL	FROM	TO	TRP TYPE	COMPL. KEYS*
A1	2010	2015	MEG / CR	
A6	2006	2011	SOK / CR	
A8	2004	2009	PH / CR2	
Q5	2009		PH / CR3	
Q7	2006		PH / CR2	
TT	2006	2014	MEG / CR	

HURSB2 2 BUTTONS 2

MODEL	FROM	TO	TRP TYPE	COMPL. KEYS*
A3	1996	2000	MEG / CR	HU66APRS
A4	1997	2001	MEG / CR	HU66APRS
A6	1997	2001	MEG / CR	HU66APRS

HURSB8 3 BUTTONS 3

See also: VOLKSWAGEN®

MODEL	FROM	TO	TRP TYPE	COMPL. KEYS*
A2	2000	2005	MEG / CR	HU66APRS
A3	1996	2003	MEG / CR	HU66APRS

A4	1999	2004	MEG / CR	HU66APRS
A6	1997	2004	MEG / CR	HU66APRS
A8	1997	2004	MEG / CR	HU66APRS
TT	1998	2006	MEG / CR	HU66APRS

HURSC2 2 BUTTONS 3

MODEL	FROM	TO	TRP TYPE	COMPL. KEYS*
A3	1996	2000	MEG / CR	HU66APRS
A4	1997	2001	MEG / CR	HU66APRS
A6	1997	2001	MEG / CR	HU66APRS

HURSC8 3 BUTTONS 3

MODEL	FROM	TO	TRP TYPE	COMPL. KEYS*
A3	1996	2003	MEG / CR	HU66APRS
A4	1997	2004	MEG / CR	HU66APRS
A6	1997	2004	MEG / CR	HU66APRS

FOR: BMW®

HU58RS2N 2 BUTTONS 4

MODEL	FROM	TO	TRP TYPE	COMPL. KEYS*
SERIE 3	1995	2001	PH	
SERIE 5	1996	2003	PH	
SERIE 7	1994	2001	PH	
Z3	1995	2002	PH	

HU58RS8N 3 BUTTONS 4

MODEL	FROM	TO	TRP TYPE	COMPL. KEYS*
SERIE 3	1995	2001	PH	
SERIE 5	1996	2003	PH	
SERIE 7	1994	2001	PH	

HU92RRS2N 2 BUTTONS 4

MODEL	FROM	TO	TRP TYPE	COMPL. KEYS*
SERIE 3	1995	2001	PH	
SERIE 5	1996	2003	PH	
SERIE 7	1994	2001	PH	
Z3	1995	2002	PH	

HU92RRS8N 3 BUTTONS 5

MODEL	FROM	TO	TRP TYPE	COMPL. KEYS*
SERIE 3	1995	2001	PH	
SERIE 5	1996	2003	PH	
SERIE 7	1994	2001	PH	

FOR: CHEVROLET® SOUTH AMERICA

HURSH2N 2 BUTTONS 5

See also: HOLDEN®, OPEL® - VAUXHALL®

MODEL	FROM	TO	TRP TYPE	COMPL. KEYS*
CORSA	2000	2004	PH / CR	HU46BT HU100BT

* COMPL. KEYS = COMPLEMENTARY KEYS

FOR: CHRYSLER®

CY24RS2 2 BUTTONS 5

MODEL	FROM	TO	TRP TYPE	COMPL. KEYS*
200	2011	2014	PH / CR2	
300	2005	2007	PH / CR2	
ASPEN	2007	2009	PH / CR2	
PACIFICA	2004	2008	PH / CR2	
PT CRUISER	2006	2011	PH / CR2	
SEBRING CONVERT	2007	2011	PH / CR2	
TOWN & COUNTRY	2004	2007	PH / CR2	
VOYAGER	2004	2007	PH / CR2	

CY24RS8 3 BUTTONS 6

MODEL	FROM	TO	TRP TYPE	COMPL. KEYS*
200	2011	2014	PH / CR2	
300	2005	2007	PH / CR2	
ASPEN	2007	2009	PH / CR2	
PACIFICA	2004	2008	PH / CR2	
PT CRUISER	2006	2011	PH / CR2	
SEBRING CONVERT	2007	2011	PH / CR2	
TOWN & COUNTRY	2004	2007	PH / CR2	
TOWN & COUNTRY	2004	2007	PH / CR2	
VOYAGER	2004	2007	PH / CR2	

SIP22CRS8 3 BUTTONS 6

See also: ABARTH®, CITROËN®, FIAT®, IVECO®, LANCIA®, PEUGEOT®

MODEL	FROM	TO	TRP TYPE	COMPL. KEYS*
YPSILON	2011		PH / CR2	

FOR: CITROËN®

HU83ARS2 2 BUTTONS 6

See also: PEUGEOT®

MODEL	FROM	TO	TRP TYPE	COMPL. KEYS*
C6	2005	2012	PH / CR2	
JUMPY	2007	2016	PH / CR2	

HU83ARS2N 2 BUTTONS 7

See also: PEUGEOT®

MODEL	FROM	TO	TRP TYPE	COMPL. KEYS*
C6	2005	2012	PH / CR2	
JUMPY	2007	2016	PH / CR2	

HU83BRS8 3 BUTTONS 7

See also: LANCIA®, PEUGEOT®

MODEL	FROM	TO	TRP TYPE	COMPL. KEYS*
C4 PICASSO	2006	2013	PH / CR2	
C5	2008		PH / CR2	
C8	2006	2014	PH / CR2	

HU83BRS8N 3 BUTTONS 7

See also: LANCIA®, PEUGEOT®

MODEL	FROM	TO	TRP TYPE	COMPL. KEYS*
C4 PICASSO	2006	2013	PH / CR2	
C5	2008		PH / CR2	
C8	2006	2014	PH / CR2	

HU83CRS7 4 BUTTONS 8

See also: LANCIA®, PEUGEOT®

MODEL	FROM	TO	TRP TYPE	COMPL. KEYS*
C8	2006	2014	PH / CR2	

HU83CRS7N 4 BUTTONS 8

See also: LANCIA®, PEUGEOT®

MODEL	FROM	TO	TRP TYPE	COMPL. KEYS*
C8	2006	2014	PH / CR2	

HU83RS2 2 BUTTONS 8

See also: FIAT®, PEUGEOT®

MODEL	FROM	TO	TRP TYPE	COMPL. KEYS*
C4 PICASSO	2006	2013	PH / CR2	
DISPATCH	2007		PH / CR2	
JUMPY	2007	2016	PH / CR2	

SIP22CRS8 3 BUTTONS 9

See also: ABARTH®, CHRYSLER®, FIAT®, IVECO®, LANCIA®, PEUGEOT®

MODEL	FROM	TO	TRP TYPE	COMPL. KEYS*
JUMPER	2009		PH / CR2	
NEMO	2008		PH / CR2	
RELAY	2009		PH / CR2	

SX9ARS2 2 BUTTONS 9

MODEL	FROM	TO	TRP TYPE	COMPL. KEYS*
BERLINGO	1998	2001	PH	
EVASION	1992	2002	PH	
SAXO	1998	2000	PH	
XSARA	1998	2001	PH	

SX9RS2 2 BUTTONS 9

See also: PEUGEOT®

MODEL	FROM	TO	TRP TYPE	COMPL. KEYS*
BERLINGO	2001	2002	PH / CR2	
XSARA PICASSO	2000	2006	PH / CR2	

SXRSA2 2 BUTTONS 10

MODEL	FROM	TO	TRP TYPE	COMPL. KEYS*
BERLINGO	1998	2001	PH	
EVASION	1998	2002	PH	
SAXO	1998	2000	PH	
XSARA	1998	2001	PH	

VA2ARS2N 2 BUTTONS 10

See also: PEUGEOT®

MODEL	FROM	TO	TRP TYPE	COMPL. KEYS*
BERLINGO	2008		PH / CR2	

* COMPL. KEYS = COMPLEMENTARY KEYS

C2	2006	2010	PH / CR2
C3	2006	2016	PH / CR2

VA2BRS2 2 BUTTONS **10**

See also: PEUGEOT®

MODEL	FROM	TO	TRP TYPE	COMPL. KEYS*
BERLINGO	2008		PH / CR2	
C2	2006	2010	PH / CR2	
C3	2006	2016	PH / CR2	

VA2BRS8 3 BUTTONS **11**

See also: PEUGEOT®

MODEL	FROM	TO	TRP TYPE	COMPL. KEYS*
C3 PICASSO	2008		PH / CR2	
C5	2006	2008	PH / CR2	
DS3	2010		PH / CR2	

VA2BRS8N 3 BUTTONS **11**

See also: PEUGEOT®

MODEL	FROM	TO	TRP TYPE	COMPL. KEYS*
C3 PICASSO	2008		PH / CR2	
C5	2006	2008	PH / CR2	
DS3	2010		PH / CR2	

VA2RS2 2 BUTTONS **11**

See also: PEUGEOT®, TOYOTA®

MODEL	FROM	TO	TRP TYPE	COMPL. KEYS*
BERLINGO	2002	2008	PH / CR2	
C1	2004	2014	TEX / CR	
C2	2003	2010	PH / CR2	
C3	2002	2006	PH / CR2	

FOR: FIAT®

GT15RARS1 1 BUTTON **12**

MODEL	FROM	TO	TRP TYPE	COMPL. KEYS*
MULTIPLA	1988	2010	MEG / CR	
PALIO	2002	2010	MEG / CR	
PUNTO	1999	2005	MEG / CR	
SEICENTO	2000	2010	MEG / CR	
SIENA	2002	2011	MEG / CR	

GT15RRS1 1 BUTTON **12**

MODEL	FROM	TO	TRP TYPE	COMPL. KEYS*
VARIOUS MODELS	2000		PH / CR2	

HU83RS2 2 BUTTONS **12**

See also: CITROËN®, PEUGEOT®

MODEL	FROM	TO	TRP TYPE	COMPL. KEYS*
SCUDO	2007	2016	PH / CR2	

SIP22ARS1 1 BUTTON **13**

MODEL	FROM	TO	TRP TYPE	COMPL. KEYS*
Doblò	2000	2006	MEG / CR	
DUCATO	2002	2005	MEG / CR	

IDEA	2003	2009	MEG / CR
PUNTO	2006	2011	MEG / CR
STILO	2001	2008	MEG / CR

SIP22CRS8 3 BUTTONS **13**

See also: ABARTH®, CHRYSLER®, CITROËN®, IVECO®, LANCIA®, PEUGEOT®

MODEL	FROM	TO	TRP TYPE	COMPL. KEYS*
500	2007		PH / CR2	
500L	2012		PH / CR2	
BRAVO	2007	2015	PH / CR2	
Doblò	2009		PH / CR2	
DUCATO	2009		PH / CR2	
FIORINO	2007		PH / CR2	
PANDA	2002		PH / CR2	
PUNTO EVO	2009	2012	PH / CR2	
PUNTO	2012		PH / CR2	
QUBO	2008		PH / CR2	

SIP22FRS8 3 BUTTONS **13**

MODEL	FROM	TO	TRP TYPE	COMPL. KEYS*
CROMA	2005	2010	PH / CR2	

SIP22RS8 3 BUTTONS **14**

See also: ABARTH®, LANCIA®

MODEL	FROM	TO	TRP TYPE	COMPL. KEYS*
BRAVO	2007	2008	MEG / CR	
DUCATO	2006	2010	MEG / CR	
IDEA	2003	2009	MEG / CR	
PUNTO	2006	2011	MEG / CR	
STILO	2001	2008	MEG / CR	

FOR: FORD EUROPE®

FORS8 3 BUTTONS **14**

MODEL	FROM	TO	TRP TYPE	COMPL. KEYS*
COUGAR	1997	2002	TEXAS	F021AP HU101AP
FIESTA	2000	2002	TEXAS	F021AP HU101AP
FOCUS	1998	2004	TEX / CR	F021AP HU101AP
KA	2000	2002	TEXAS	F021AP HU101AP
KA	2002	2008	TEX / CR	F021AP HU101AP
MONDEO	1998	2001	TEXAS	F021AP HU101AP
MONDEO	2001	2007	TEX / CR	F021AP HU101AP
PUMA	1998	2002	TEXAS	F021AP HU101AP
TOURNEO CONNECT	2002	2008	TEX / CR	F021AP HU101AP
TRANSIT CONNECT	2002	2008	TEX / CR	F021AP HU101AP

* COMPL. KEYS = COMPLEMENTARY KEYS



General Index

TRANSIT 2000 2006 TEX / CR FQ21AP
HU101AP

FORSAB 3 BUTTONS **14**

MODEL	FROM	TO	TRP TYPE	COMPL. KEYS*
B-MAX	2012		TEX / 80	HU101ARS8
ECOSPORT	2013		TEX / 80	HU101ARS8
FIESTA	2003	2008	TEX / CR	HU101ARS8
FOCUS C-MAX	2003	2010	TEX / CR	HU101ARS8
FOCUS	2004	2010	TEX / CR	HU101ARS8
GALAXY	2006	2010	TEX / CR	HU101ARS8
GALAXY	2010	2014	TEX / 80	HU101ARS8
MONDEO	2007	2010	TEX / CR	HU101ARS8
MONDEO	2011	2014	TEX / 80	HU101ARS8
S-MAX	2006	2010	TEX / CR	HU101ARS8
S-MAX	2010	2014	TEX / 80	HU101ARS8

HU101ARS8 **15**

MODEL	FROM	TO	TRP TYPE	COMPL. KEYS*
B-MAX	2012		TEX / 80	
ECOSPORT	2013		TEX / 80	
FIESTA	2003	2008	TEX / CR	
FOCUS C-MAX	2003	2010	TEX / CR	
FOCUS	2004	2010	TEX / CR	
GALAXY	2006	2010	TEX / CR	
GALAXY	2010	2014	TEX / 80	
MONDEO	2007	2010	TEX / CR	
MONDEO	2011	2014	TEX / 80	
S-MAX	2006	2010	TEX / CR	
S-MAX	2010	2014	TEX / 80	

SIP22ERS8 3 BUTTONS **15**

MODEL	FROM	TO	TRP TYPE	COMPL. KEYS*
KA	2008	2016	PH / CR2	

FOR: HOLDEN®

HURSH2N 2 BUTTONS **15**

See also: CHEVROLET® SOUTH AMERICA, OPEL® - VAUXHALL®

MODEL	FROM	TO	TRP TYPE	COMPL. KEYS*
BARINA	2000	2006	PH / CR	HU46BT HU100BT

FOR: HONDA®

HON66RS3 2 BUTTONS **16**

MODEL	FROM	TO	TRP TYPE	COMPL. KEYS*
ACCORD	2003	2007	PH / CR2	
CIVIC	2006	2014	PH / CR2	
CR-V	2007	2012	PH / CR2	
JAZZ	2009	2014	PH / CR2	
STREAM	2008		PH / CR2	

HON66RS4 2 BUTTONS **16**

MODEL	FROM	TO	TRP TYPE	COMPL. KEYS*
ACCORD	2003	2006	MEG / CR	
ACCORD	2006	2008	SOK / CR	
CIVIC	2002	2005	MEG / CR	
CR-V	2002	2006	MEG / CR	
FR-V	2004	2007	MEG / CR	
FR-V	2007	2011	SOK / CR	
JAZZ	2001	2007	MEG / CR	
JAZZ	2006	2008	SOK / CR	
LEGEND	2007	2012	SOK / CR	
S2000	2004	2005	MEG / CR	
S2000	2006	2010	SOK / CR	

HON66RS5 3 BUTTONS **16**

MODEL	FROM	TO	TRP TYPE	COMPL. KEYS*
ACCORD	2003	2007	PH / CR2	
CIVIC	2006	2014	PH / CR2	
CR-V	2007	2012	PH / CR2	
JAZZ	2009	2014	PH / CR2	
STREAM	2008		PH / CR2	

HON66RS6 3 BUTTONS **17**

MODEL	FROM	TO	TRP TYPE	COMPL. KEYS*
ACCORD	2003	2006	MEG / CR	
ACCORD	2006	2008	SOK / CR	
CIVIC	2002	2005	MEG / CR	
CR-V	2002	2006	MEG / CR	
FR-V	2004	2007	MEG / CR	
FR-V	2007	2011	SOK / CR	
JAZZ	2001	2007	MEG / CR	
JAZZ	2006	2008	SOK / CR	
LEGEND	2007	2012	SOK / CR	
S2000	2004	2005	MEG / CR	
S2000	2006	2010	SOK / CR	

FOR: HONDA® USA

HON66RS1 1 BUTTON **17**

MODEL	FROM	TO	TRP TYPE	COMPL. KEYS*
ODYSSEY	2003	2004	MEG	

HON66RS2 2 BUTTONS **17**

MODEL	FROM	TO	TRP TYPE	COMPL. KEYS*
ODYSSEY	2003	2004	MEG	

FOR: HYUNDAI®

HYN12RS1 1 BUTTON **18**

MODEL	FROM	TO	TRP TYPE	COMPL. KEYS*
H-1	1999	2006	TEXAS	
H-200	1998	2006	TEXAS	
STAREX	1998	2006	TEXAS	

* COMPL. KEYS = COMPLEMENTARY KEYS

KIA8RS8		3 BUTTONS			18
MODEL	FROM	TO	TRP TYPE	COMPL. KEYS*	
I10	2014		PH / CR3		
I20	2014		PH / CR3		
I40	2013	2015	TEX / 80		
IX35	2013	2015	PH / CR2		
TUCSON	2015		TEX / 80		

FOR: IVECO®

GT10RS1					18
MODEL	FROM	TO	TRP TYPE	COMPL. KEYS*	
DAILY	2001	2006	PH / CR2		

SIP22CRS8		3 BUTTONS			19
See also: ABARTH®, CHRYSLER®, CITROËN®, FIAT®, LANCIA®, PEUGEOT®					
MODEL	FROM	TO	TRP TYPE	COMPL. KEYS*	
DAILY	2012		PH / CR2		

FOR: LANCIA®

HU83BRS8		3 BUTTONS			19
See also: CITROËN®, PEUGEOT®					
MODEL	FROM	TO	TRP TYPE	COMPL. KEYS*	
PHEDRA	2006	2010	PH / CR2		

HU83BRS8N		3 BUTTONS			19
See also: CITROËN®, PEUGEOT®					
MODEL	FROM	TO	TRP TYPE	COMPL. KEYS*	
PHEDRA	2006	2010	PH / CR2		

HU83CRS7		4 BUTTONS			20
See also: CITROËN®, PEUGEOT®					
MODEL	FROM	TO	TRP TYPE	COMPL. KEYS*	
PHEDRA	2006	2010	PH / CR2		

HU83CRS7N		4 BUTTONS			20
See also: CITROËN®, PEUGEOT®					
MODEL	FROM	TO	TRP TYPE	COMPL. KEYS*	
PHEDRA	2006	2010	PH / CR2		

SIP22CRS8		3 BUTTONS			20
See also: ABARTH®, CHRYSLER®, CITROËN®, FIAT®, IVECO®, PEUGEOT®					
MODEL	FROM	TO	TRP TYPE	COMPL. KEYS*	
DELTA	2008	2010	MEG / CR		
DELTA	2008	2014	PH / CR2		
MUSA	2009	2012	PH / CR2		
YPSILON	2011		PH / CR2		

SIP22RS8		3 BUTTONS			21
See also: ABARTH®, FIAT®					
MODEL	FROM	TO	TRP TYPE	COMPL. KEYS*	
LYBRA	2002	2006	MEG / CR		
MUSA	2004	2009	MEG / CR		

THESIS	2002	2009	MEG / CR		
YPSILON	2003	2011	MEG / CR		

FOR: LEXUS®

TOY40BRS2		2 BUTTONS			21
See also: TOYOTA® JAPAN, TOYOTA®					
MODEL	FROM	TO	TRP TYPE	COMPL. KEYS*	
CELSIOR [J]	1997	2000	TEXAS		
ES300	1998	2001	TEXAS		
LAND CRUISER (JPN)	1999		TEXAS		
LS400	1997	2000	TEXAS		
LX450	1998	1998	TEXAS		
LX470	1998	2000	TEXAS		
SC300/400	1998	2006	TEXAS		

TOY40BRS8		3 BUTTONS			21
See also: TOYOTA® JAPAN, TOYOTA®					
MODEL	FROM	TO	TRP TYPE	COMPL. KEYS*	
CELSIOR [J]	1997	2000	TEXAS		
ES300	1998	2001	TEXAS		
LAND CRUISER (JPN)	1999		TEXAS		
LS400	1997	2000	TEXAS		
LX450	1998	1998	TEXAS		
LX470	1998	2000	TEXAS		
SC300/400	1998	2006	TEXAS		

TOY48BRS2		2 BUTTONS			22
See also: TOYOTA® JAPAN, TOYOTA®					
MODEL	FROM	TO	TRP TYPE	COMPL. KEYS*	
ALTEZZA [J]	1999	2005	TEXAS		
ES300	2002	2003	TEXAS		
GS/LS/LX	1998	2006	TEXAS		
IS200	1999	2005	TEXAS		
IS300	2001	2005	TEXAS		
RX300	1997	2003	TEXAS		

TOY48BRS8		3 BUTTONS			22
See also: TOYOTA® JAPAN, TOYOTA®					
MODEL	FROM	TO	TRP TYPE	COMPL. KEYS*	
ALTEZZA [J]	1999	2005	TEXAS		
ES300	2002	2003	TEXAS		
GS/LS/LX	1998	2006	TEXAS		
IS200	1999	2005	TEXAS		
IS300	2001	2005	TEXAS		
RX300	1997	2003	TEXAS		

FOR: MARUTI SUZUKI®

HU133RDRS1		1 BUTTON			22
MODEL	FROM	TO	TRP TYPE	COMPL. KEYS*	
ALTO K10	2010		PH / CR2		
A-STAR	2007		PH / CR2		
RITZ	2007		PH / CR2		

* COMPL. KEYS = COMPLEMENTARY KEYS



General Index

SWIFT	2007		PH / CR2
SX4	2007		PH / CR2
WAGON R	2010		PH / CR2

SZ11RDRS1 1 BUTTON 23

MODEL	FROM	TO	TRP TYPE	COMPL. KEYS*
VERSA	2007	2010	TEX / CR	
WAGON R	2007	2010	TEX / CR	
ZEN ESTILO	2007	2010	TEX / CR	

FOR: MERCEDES®

HURS5 3 BUTTONS 23

MODEL	FROM	TO	TRP TYPE	COMPL. KEYS*
B - CLASS	2005	2010		
C - CLASS	2001	2007		
CLK	2001	2009		
E - CLASS	1998	2009		
ML - CLASS	2005	2010		
S - CLASS	1999	2006		
SLK	2005	2010		

FOR: MINI®

HU200RS2 2 BUTTONS 23

MODEL	FROM	TO	TRP TYPE	COMPL. KEYS*
COOPER	2001	2006	PH	
ONE	2001	2006	PH	

FOR: MITSUBISHI®

MIT8RS2 2 BUTTONS 24

MODEL	FROM	TO	TRP TYPE	COMPL. KEYS*
L200	2006	2015	PH / CR2	
PAJERO	2006		PH / CR2	

FOR: NISSAN®

NSN14RS2 2 BUTTONS 24

MODEL	FROM	TO	TRP TYPE	COMPL. KEYS*
MICRA	2010	2016	PH / CR2	
NOTE	2013		PH / CR3	

NSN14RS8 3 BUTTONS 24

MODEL	FROM	TO	TRP TYPE	COMPL. KEYS*
JUKE	2010		PH / CR2	
QASHQAI	2010	2013	PH / CR2	

NSNRS2 2 BUTTONS 25

See also: NISSAN® (TRUCKS)

MODEL	FROM	TO	TRP TYPE	COMPL. KEYS*
ALMERA TINO	2000	2003	TEX / CR	
ALMERA	1999	2000	PH / CR	
ALMERA	2000	2003	TEX / CR	

MAXIMA	2000	2003	PH / CR	
MICRA MARCH [J]	1998	2000	PH / CR	
MICRA MARCH [J]	2000	2003	TEX / CR	
MICRA VAN	1998	2000	PH / CR	
MICRA VAN	2000	2003	TEX / CR	
MICRA	1998	2000	PH / CR	
MICRA	2000	2003	TEX / CR	
MURANO	2003	2008	TEX / CR	
NAVARA	2000	2003	PH / CR	
NAVARA	2003	2005	TEX / CR	
NX ALMERA	1998	2003	PH / CR	
PATROL	1998	2003	PH / CR	
PATROL	2002	2004	TEX / CR	
PRIMERA	1998	2000	PH / CR	
PRIMERA	2000	2002	TEX / CR	
PULSAR	1998	2000	PH / CR	
PULSAR	2000	2004	TEX / CR	
TERRANO II	1998	2001	PH / CR	
TERRANO II	2002	2006	TEX / CR	
VANETTE CARGO	1999	2000	PH / CR	
VANETTE CARGO	2000	2001	TEX / CR	
VANETTE	2000	2002	TEX / CR	
X-TRAIL [J]	1998	2000	PH / CR	
X-TRAIL	2001	2006	TEX / CR	

FOR: NISSAN® (TRUCKS)

NSNRS2 2 BUTTONS 25

See also: NISSAN®

MODEL	FROM	TO	TRP TYPE	COMPL. KEYS*
ATLEON	2002	2006	TEX / CR	
CAB STAR	2000	2007	TEX / CR	

FOR: OPEL® - VAUXHALL®

HU100RS2 2 BUTTONS 25

MODEL	FROM	TO	TRP TYPE	COMPL. KEYS*
ASTRA	2004	2009	PH / CR2	
COMBO	2007	2011	PH / CR	
CORSA	2004	2006	PH / CR	
MERIVA	2006	2010	PH / CR	
SIGNUM	2003	2008	PH / CR2	
TIGRA	2004	2009	PH / CR	
VECTRA	2004	2008	PH / CR2	

HU100RS8 3 BUTTONS 26

MODEL	FROM	TO	TRP TYPE	COMPL. KEYS*
ASTRA	2004	2009	PH / CR2	
SIGNUM	2003	2008	PH / CR2	
VECTRA	2004	2008	PH / CR2	
ZAFIRA	2005	2013	PH / CR2	

* COMPL. KEYS = COMPLEMENTARY KEYS

HU87RS2 2 BUTTONS 26

See also: SUBARU®, SUZUKI®

MODEL	FROM	TO	TRP TYPE	COMPL. KEYS*
AGILA	2000	2004	PH / CR	

HURSG2N 2 BUTTONS 26

MODEL	FROM	TO	TRP TYPE	COMPL. KEYS*
ASTRA	1998	2004	PH / CR	HU46AT YM28AT HU43AT

OMEGA	1998	2003	PH / CR	HU46AT YM28AT HU43AT
-------	------	------	---------	----------------------------

HURSG8N 3 BUTTONS 27

MODEL	FROM	TO	TRP TYPE	COMPL. KEYS*
ASTRA	1998	2004	PH / CR	HU46AT YM28AT HU43AT

OMEGA	1998	2003	PH / CR	HU46AT YM28AT HU43AT
-------	------	------	---------	----------------------------

HURSH2N 2 BUTTONS 27

See also: CHEVROLET® SOUTH AMERICA, HOLDEN®

MODEL	FROM	TO	TRP TYPE	COMPL. KEYS*
AGILA	2004	2008	PH / CR	HU46BT HU100BT

CORSA	2000	2006	PH / CR	HU46BT HU100BT
-------	------	------	---------	-------------------

MERIVA	2002	2010	PH / CR	HU46BT HU100BT
--------	------	------	---------	-------------------

TIGRA	2004	2009	PH / CR	HU46BT HU100BT
-------	------	------	---------	-------------------

NERS5 3 BUTTONS 27

See also: RENAULT®

MODEL	FROM	TO	TRP TYPE	COMPL. KEYS*
MOVANO	2007	2010	PH / CR2	
VIVARO	2007	2010	PH / CR2	

VACRS2 2 BUTTONS 28

See also: RENAULT®

MODEL	FROM	TO	TRP TYPE	COMPL. KEYS*
MOVANO	2007	2010	PH / CR2	
VIVARO	2007	2010	PH / CR2	

VACRSA2 2 BUTTONS 28

See also: RENAULT® - DACIA®, RENAULT®

MODEL	FROM	TO	TRP TYPE	COMPL. KEYS*
MOVANO	2002	2010	PH / CR2	

FOR: PEUGEOT®

HU83ARS2 2 BUTTONS 28

See also: CITROËN®

MODEL	FROM	TO	TRP TYPE	COMPL. KEYS*
207	2006	2015	PH / CR2	
3008	2009		PH / CR2	
307	2001	2009	PH / CR2	
EXPERT	2007	2016	PH / CR2	

HU83ARS2N 2 BUTTONS 29

See also: CITROËN®

MODEL	FROM	TO	TRP TYPE	COMPL. KEYS*
207	2006	2015	PH / CR2	
3008	2009		PH / CR2	
307	2001	2009	PH / CR2	
EXPERT	2007	2016	PH / CR2	

HU83BRS8 3 BUTTONS 29

See also: CITROËN®, LANCIA®

MODEL	FROM	TO	TRP TYPE	COMPL. KEYS*
3008	2009		PH / CR2	
308	2007	2013	PH / CR2	
5008	2009		PH / CR2	
807	2006	2014	PH / CR2	

HU83BRS8N 3 BUTTONS 29

See also: CITROËN®, LANCIA®

MODEL	FROM	TO	TRP TYPE	COMPL. KEYS*
3008	2009		PH / CR2	
308	2007	2013	PH / CR2	
5008	2009		PH / CR2	
807	2006	2014	PH / CR2	

HU83CRS7 4 BUTTONS 30

See also: CITROËN®, LANCIA®

MODEL	FROM	TO	TRP TYPE	COMPL. KEYS*
807	2006	2014	PH / CR2	

HU83CRS7N 4 BUTTONS 30

See also: CITROËN®, LANCIA®

MODEL	FROM	TO	TRP TYPE	COMPL. KEYS*
807	2006	2014	PH / CR2	

HU83RS2 2 BUTTONS 30

See also: CITROËN®, FIAT®

MODEL	FROM	TO	TRP TYPE	COMPL. KEYS*
307	2001	2009	PH / CR2	
EXPERT	2007	2016	PH / CR2	

NE73RS2 2 BUTTONS 31

MODEL	FROM	TO	TRP TYPE	COMPL. KEYS*
106	2000	2004	PH / CR2	
206 Cabrio	2002	2007	PH / CR2	
206 PLUS	2009	2012	PH / CR2	

* COMPL. KEYS = COMPLEMENTARY KEYS



General Index

206 2001 2009 PH / CR2

NE78ARS2N 2 BUTTONS **31**

MODEL	FROM	TO	TRP TYPE	COMPL. KEYS*
406	2002	2004	PH / CR2	
607	2004	2010	PH / CR2	

NE78BRS8 3 BUTTONS **31**

MODEL	FROM	TO	TRP TYPE	COMPL. KEYS*
406	2002	2004	PH / CR2	
607	2004	2010	PH / CR2	

NE78BRS8N 3 BUTTONS **32**

MODEL	FROM	TO	TRP TYPE	COMPL. KEYS*
406	2002	2004	PH / CR2	
607	2004	2010	PH / CR2	

NE78RS2N 2 BUTTONS **32**

MODEL	FROM	TO	TRP TYPE	COMPL. KEYS*
406	2002	2004	PH / CR2	
607	2004	2010	PH / CR2	

SIP22CRS8 3 BUTTONS **32**

See also: ABARTH®, CHRYSLER®, CITROËN®, FIAT®, IVECO®, LANCIA®

MODEL	FROM	TO	TRP TYPE	COMPL. KEYS*
BIPPER	2009		PH / CR2	
BOXER	2009		PH / CR2	

SX9RS2 2 BUTTONS **33**

See also: CITROËN®

MODEL	FROM	TO	TRP TYPE	COMPL. KEYS*
EXPERT	2002	2006	PH / CR2	
PARTNER	2001	2002	PH / CR2	

VA2ARS2N 2 BUTTONS **33**

See also: CITROËN®

MODEL	FROM	TO	TRP TYPE	COMPL. KEYS*
407	2004	2008	PH / CR2	

VA2BRS2 2 BUTTONS **33**

See also: CITROËN®

MODEL	FROM	TO	TRP TYPE	COMPL. KEYS*
407	2004	2008	PH / CR2	

VA2BRS8 3 BUTTONS **34**

See also: CITROËN®

MODEL	FROM	TO	TRP TYPE	COMPL. KEYS*
407	2008	2011	PH / CR2	

VA2BRS8N 3 BUTTONS **34**

See also: CITROËN®

MODEL	FROM	TO	TRP TYPE	COMPL. KEYS*
407	2008	2011	PH / CR2	

VA2CRS7 4 BUTTONS **34**

MODEL	FROM	TO	TRP TYPE	COMPL. KEYS*
1007	2004	2010	PH / CR2	

VA2CRS7N 4 BUTTONS **35**

MODEL	FROM	TO	TRP TYPE	COMPL. KEYS*
1007	2004	2010	PH / CR2	

VA2RS2 2 BUTTONS **35**

See also: CITROËN®, TOYOTA®

MODEL	FROM	TO	TRP TYPE	COMPL. KEYS*
107	2005	2014	TEX / CR	
PARTNER	2002		PH / CR2	
RANCH	2002	2007	PH / CR2	

FOR: PORSCHE®

HU66RS1 1 BUTTON **35**

MODEL	FROM	TO	TRP TYPE	COMPL. KEYS*
911	1999	2004	MEG / CR	
BOXSTER	1999	2004	MEG / CR	

HU66RS2 2 BUTTONS **36**

MODEL	FROM	TO	TRP TYPE	COMPL. KEYS*
911	1999	2004	MEG / CR	
BOXSTER	1999	2004	MEG / CR	

HU66RS8 3 BUTTONS **36**

MODEL	FROM	TO	TRP TYPE	COMPL. KEYS*
911	1999	2004	MEG / CR	
BOXSTER	1999	2004	MEG / CR	

FOR: RENAULT®

NE73ARS1 1 BUTTON **36**

MODEL	FROM	TO	TRP TYPE	COMPL. KEYS*
CLIO	1995	1997	PH	
ESPACE 3	1997	2002	PH	
LAGUNA	1995	2000	PH	
MASTER	1998	2001	PH	
MEGANE	1996	1998	PH	
SAFRANE	1995	2001	PH	

NE73BRS1 1 BUTTON **37**

MODEL	FROM	TO	TRP TYPE	COMPL. KEYS*
CLIO		1995		
LAGUNA		1995		
MEGANE		1995		

NERS5 3 BUTTONS **37**

See also: OPEL® - VAUXHALL®

MODEL	FROM	TO	TRP TYPE	COMPL. KEYS*
MASTER	2007	2010	PH / CR2	
TRAFIC	2007	2010	PH / CR2	

* COMPL. KEYS = COMPLEMENTARY KEYS

NERSD1N 1 BUTTON 37				
MODEL	FROM	TO	TRP TYPE	COMPL. KEYS*
CLIO 2	2001	2012	PH / CR2	
KANGOO	2002	2008	PH / CR2	

VA150RS8 3 BUTTONS 38				
MODEL	FROM	TO	TRP TYPE	COMPL. KEYS*
MEGANE 2	2002	2008	PH / CR2	
SCENIC 2	2002	2008	PH / CR2	

VA2ERS2 2 BUTTONS 38				
MODEL	FROM	TO	TRP TYPE	COMPL. KEYS*
CLIO 4	2012		PH / CR3	
TWINGO	2014		PH / CR3	

VA2ERS8 3 BUTTONS 38				
MODEL	FROM	TO	TRP TYPE	COMPL. KEYS*
CLIO 4	2012		PH / CR3	
TWINGO	2014		PH / CR3	

VAC102ARS1 1 BUTTON 39				
MODEL	FROM	TO	TRP TYPE	COMPL. KEYS*
CLIO	1995	1997	PH	
KANGOO	1998	2001	PH	
LAGUNA	1995	2000	PH	
SAFRANE	1995	2001	PH	

VAC102B1N 1 BUTTON 39				
MODEL	FROM	TO	TRP TYPE	COMPL. KEYS*
CLIO	1995	1997	PH	
KANGOO	1998	2001	PH	
LAGUNA	1995	2000	PH	
SAFRANE	1995	2001	PH	

VACRS2 2 BUTTONS 39				
See also: OPEL® - VAUXHALL®				
MODEL	FROM	TO	TRP TYPE	COMPL. KEYS*
KANGOO	2008		PH / CR2	
MASTER	2011	2014	PH / CR2	
TRAFIC	2010	2014	PH / CR2	

VACRSA2 2 BUTTONS 40				
See also: OPEL® - VAUXHALL®, RENAULT® - DACIA®				
MODEL	FROM	TO	TRP TYPE	COMPL. KEYS*
KANGOO	2002	2008	PH / CR2	
MASTER	2002	2010	PH / CR2	
TWINGO	2002	2007	PH / CR2	

FOR: RENAULT® - DACIA®

VACRSA2 2 BUTTONS 40				
See also: OPEL® - VAUXHALL®, RENAULT®				
MODEL	FROM	TO	TRP TYPE	COMPL. KEYS*
LOGAN	2004	2012	PH / CR2	
SANDERO	2008	2013	PH / CR2	

FOR: SEAT®

HU66BRS8 3 BUTTONS 40				
See also: SKODA®, VOLKSWAGEN®				
MODEL	FROM	TO	TRP TYPE	COMPL. KEYS*
ALTEA	2004	2008	MEG / CR	
EXEO	2008	2013	MEG / CR	
IBIZA	2008		MEG / CR	
LEON	2009	2012	MEG / CR	

HU66PRS 41				
See also: SKODA®, VOLKSWAGEN®				
MODEL	FROM	TO	TRP TYPE	COMPL. KEYS*
ALTEA XL	2006	2008	MEG / CR	
ALTEA	2004	2008	MEG / CR	
IBIZA	2004	2009	MEG / CR	
LEON	2005	2008	MEG / CR	
TOLEDO	2004	2009	MEG / CR	

HURSA2 2 BUTTONS 41				
See also: SKODA®, VOLKSWAGEN®				
MODEL	FROM	TO	TRP TYPE	COMPL. KEYS*
ALTEA XL	2006	2008	MEG / CR	HU66PRS
ALTEA	2004	2008	MEG / CR	HU66PRS
IBIZA	2004	2009	MEG / CR	HU66PRS
LEON	2005	2008	MEG / CR	HU66PRS
TOLEDO	2004	2009	MEG / CR	HU66PRS

HURSA8 3 BUTTONS 41				
See also: SKODA®, VOLKSWAGEN®				
MODEL	FROM	TO	TRP TYPE	COMPL. KEYS*
ALTEA XL	2006	2008	MEG / CR	HU66PRS
ALTEA	2004	2008	MEG / CR	HU66PRS
IBIZA	2004	2009	MEG / CR	HU66PRS
LEON	2005	2008	MEG / CR	HU66PRS
TOLEDO	2004	2009	MEG / CR	HU66PRS

FOR: SKODA®

HU66BRS8 3 BUTTONS 42				
See also: SEAT®, VOLKSWAGEN®				
MODEL	FROM	TO	TRP TYPE	COMPL. KEYS*
OCTAVIA	2007	2012	MEG / CR	
SUPERB	2008	2010	MEG / CR	
YETI	2009	2016	MEG / CR	

HU66PRS 42				
See also: SEAT®, VOLKSWAGEN®				
MODEL	FROM	TO	TRP TYPE	COMPL. KEYS*
OCTAVIA	2004	2006	MEG / CR	
ROOMSTER SCOUT	2007	2008	MEG / CR	
ROOMSTER	2006	2008	MEG / CR	

* COMPL. KEYS = COMPLEMENTARY KEYS



General Index

HURSA2 2 BUTTONS 42

See also: SEAT®, VOLKSWAGEN®

MODEL	FROM	TO	TRP TYPE	COMPL. KEYS*
OCTAVIA	2004	2006	MEG / CR	HU66PRS
ROOMSTER SCOUT	2007	2008	MEG / CR	HU66PRS
ROOMSTER	2006	2008	MEG / CR	HU66PRS

HURSA8 3 BUTTONS 43

See also: SEAT®, VOLKSWAGEN®

MODEL	FROM	TO	TRP TYPE	COMPL. KEYS*
OCTAVIA	2004	2006	MEG / CR	HU66PRS
ROOMSTER SCOUT	2007	2008	MEG / CR	HU66PRS
ROOMSTER	2006	2008	MEG / CR	HU66PRS

FOR: SMART®

VA2DRS10 4 BUTTONS 43

MODEL	FROM	TO	TRP TYPE	COMPL. KEYS*
FORTWO	2007	2014	PH / CR2	

VA2DRS8 3 BUTTONS 43

MODEL	FROM	TO	TRP TYPE	COMPL. KEYS*
FORTWO	2007	2014	PH / CR2	

YM23RS1 1 BUTTON 44

MODEL	FROM	TO	TRP TYPE	COMPL. KEYS*
CITY COUPE	1999	2003		
CROSSBLADE	2002	2003		

YM23RS8 3 BUTTONS 44

MODEL	FROM	TO	TRP TYPE	COMPL. KEYS*
FORTWO	2003	2007		
ROADSTER	2003	2006		

YMRS1 1 BUTTON 61

MODEL	FROM	TO	TRP TYPE	COMPL. KEYS*
CITY COUPE	1999	2003		
CROSSBLADE	2002	2003		

YMRS8 3 BUTTONS 61

MODEL	FROM	TO	TRP TYPE	COMPL. KEYS*
FORTWO	2003	2007		
ROADSTER	2003	2006		

FOR: SUBARU®

HU87RS2 2 BUTTONS 44

See also: OPEL® - VAUXHALL®, SUZUKI®

MODEL	FROM	TO	TRP TYPE	COMPL. KEYS*
G3X JUSTY	2004	2007	TEX / CR	

TOY43CRS7N 4 BUTTONS 45

See also: TOYOTA®

MODEL	FROM	TO	TRP TYPE	COMPL. KEYS*
BRZ	2012		TEX / 80	

FOR: SUZUKI®

HU87RS2 2 BUTTONS 45

See also: OPEL® - VAUXHALL®, SUBARU®

MODEL	FROM	TO	TRP TYPE	COMPL. KEYS*
IGNIS	2000	2005	TEX / CR	
WAGON R	2000	2008	PH / CR	

SZ11RRS2 2 BUTTONS 45

MODEL	FROM	TO	TRP TYPE	COMPL. KEYS*
SWIFT	2000	2005	TEX / CR	

FOR: TOYOTA®

TOY40BRS2 2 BUTTONS 46

See also: LEXUS®, TOYOTA® JAPAN

MODEL	FROM	TO	TRP TYPE	COMPL. KEYS*
CENTURY	1998	2004	TEXAS	
LAND CRUISER 100	1998	2000	TEXAS	

TOY40BRS8 3 BUTTONS 46

See also: LEXUS®, TOYOTA® JAPAN

MODEL	FROM	TO	TRP TYPE	COMPL. KEYS*
CENTURY	1998	2004	TEXAS	
LAND CRUISER 100	1998	2000	TEXAS	
TARAGO	1995	1998	TEXAS	

TOY41RBR8S 3 BUTTONS 46

See also: TOYOTA® JAPAN, TOYOTA® USA

MODEL	FROM	TO	TRP TYPE	COMPL. KEYS*
ECHO	1999	2005	TEXAS	
MR2	1997	2007	TEXAS	
YARIS	1999	2005	TEXAS	

TOY41RRS2 2 BUTTONS 47

See also: TOYOTA® JAPAN, TOYOTA® USA

MODEL	FROM	TO	TRP TYPE	COMPL. KEYS*
ECHO	1999	2005	TEXAS	
MR2	1997	2007	TEXAS	
YARIS	1999	2005	TEXAS	

TOY43ARS2 2 BUTTONS 47

See also: TOYOTA® USA

MODEL	FROM	TO	TRP TYPE	COMPL. KEYS*
AURIS	2006	2012	TEX / CR	
COROLLA	2007	2010	TEX / CR	
HILUX	2005	2009	TEX / CR	
INNOVA KIJANG	2005	2009	TEX / CR	
LAND CRUISER 200	2011	2015	TEX / 80	
LAND CRUISER PRADO	2009	2010	TEX / 80	
PREVIA	2006		TEX / CR	
RAV 4	2005	2010	TEX / CR	
TARAGO	2006		TEX / CR	
WISH	2004	2009	TEX / CR	

* COMPL. KEYS = COMPLEMENTARY KEYS

General Index



YARIS 2005 2011 TEX / CR

TOY43ARS7 4 BUTTONS 47

See also: TOYOTA® USA

MODEL	FROM	TO	TRP TYPE	COMPL. KEYS*
PREVIA	2006		TEX / CR	
TARAGO	2006		TEX / CR	

TOY43BRS2 2 BUTTONS 48

See also: TOYOTA® JAPAN, TOYOTA® USA

MODEL	FROM	TO	TRP TYPE	COMPL. KEYS*
CELICA	2000	2005	TEXAS	
COROLLA	1996	1999	TEXAS	
HIACE	1995	2006	TEXAS	
HILUX	1999	2004	TEXAS	
LAND CRUISER PRADO	2002	2008	TEX / CR	
PICNIC	1996	2003	TEXAS	
PREVIA	2000	2005	TEXAS	
PRIUS	2000	2003	TEXAS	
RAV 4	1996	2004	TEXAS	
TARAGO	2000	2005	TEXAS	

TOY43BRS8 3 BUTTONS 48

See also: TOYOTA® JAPAN, TOYOTA® USA

MODEL	FROM	TO	TRP TYPE	COMPL. KEYS*
AVENSIS VERSO	2004	2009	TEX / CR	
CELICA	2000	2005	TEXAS	
COROLLA	1996	1999	TEXAS	
COROLLA	2000	2006	TEXAS	
HIACE	1995	2006	TEXAS	
LAND CRUISER PRADO	2002	2008	TEX / CR	
PICNIC	1996	2003	TEXAS	
PRIUS	2000	2003	TEXAS	
RAV 4	1996	2004	TEXAS	

TOY43CRS2N 2 BUTTONS 48

MODEL	FROM	TO	TRP TYPE	COMPL. KEYS*
HILUX	2009	2015	TEX / 80	

TOY43CRS7N 4 BUTTONS 49

See also: SUBARU®

MODEL	FROM	TO	TRP TYPE	COMPL. KEYS*
GT 86	2012		TEX / 80	
VERSO-S	2011	2014	TEX / 80	
YARIS	2011	2014	TEX / 80	

TOY47BRS2 2 BUTTONS 49

MODEL	FROM	TO	TRP TYPE	COMPL. KEYS*
AVENSIS	1998	2000	TEXAS	
AVENSIS	2000	2003	TEX / CR	
AVENSIS	2003	2006	TEX / CR	
CARINA	1996	2000	TEXAS	
COROLLA	1999	2006	TEXAS	
YARIS	1999	2005	TEXAS	

TOY47BRS8 3 BUTTONS 49

MODEL	FROM	TO	TRP TYPE	COMPL. KEYS*
AVENSIS	1998	2000	TEXAS	
AVENSIS	2000	2003	TEX / CR	
AVENSIS	2003	2006	TEX / CR	
CARINA	1996	2000	TEXAS	
COROLLA	1999	2006	TEXAS	
YARIS	1999	2005	TEXAS	

TOY48BRS2 2 BUTTONS 50

See also: LEXUS®, TOYOTA® JAPAN

MODEL	FROM	TO	TRP TYPE	COMPL. KEYS*
LAND CRUISER 100	1996	2003	TEXAS	

TOY48BRS8 3 BUTTONS 50

See also: LEXUS®, TOYOTA® JAPAN

MODEL	FROM	TO	TRP TYPE	COMPL. KEYS*
LAND CRUISER 100	1996	2003	TEXAS	

TOYRSE2 2 BUTTONS 50

See also: TOYOTA® JAPAN

MODEL	FROM	TO	TRP TYPE	COMPL. KEYS*
COROLLA VERSO	2005	2010	TEX / CR	
PRIUS	2004	2009	TEX / CR	

VA2RS2 2 BUTTONS 51

See also: CITROËN®, PEUGEOT®

MODEL	FROM	TO	TRP TYPE	COMPL. KEYS*
AYGO	2005	2014	TEX / CR	

TOYRS8 3 BUTTONS 61

See also: TOYOTA® JAPAN, TOYOTA® USA

MODEL	FROM	TO	TRP TYPE	COMPL. KEYS*
AVENSIS VERSO	2004	2009	TEX / CR	
AVENSIS	1998	2000	TEXAS	
AVENSIS	2000	2003	TEX / CR	
AVENSIS	2003	2006	TEX / CR	
CARINA	1996	2000	TEXAS	
CELICA	2000	2005	TEXAS	
CENTURY	1998	2004	TEXAS	
COROLLA	1999	2006	TEXAS	
COROLLA	2000	2006	TEXAS	
ECHO	1999	2005	TEXAS	
HIACE	1995	2006	TEXAS	
LAND CRUISER 100	1996	2003	TEXAS	
LAND CRUISER 100	1998	2000	TEXAS	
LAND CRUISER PRADO	2002	2008	TEX / CR	
MR2	1997	2007	TEXAS	
PICNIC	1996	2003	TEXAS	
PRIUS	2000	2003	TEXAS	
RAV 4	1996	2004	TEXAS	
TARAGO	1995	1998	TEXAS	
YARIS	1999	2005	TEXAS	
YARIS	1999	2005	TEXAS	

* COMPL. KEYS = COMPLEMENTARY KEYS



General Index

FOR: TOYOTA® JAPAN

TOY40BRS2 2 BUTTONS **51**
See also: LEXUS®, TOYOTA®

MODEL	FROM	TO	TRP TYPE	COMPL. KEYS*
CELSIOR	1998	2004	TEXAS	

TOY40BRS8 3 BUTTONS **51**
See also: LEXUS®, TOYOTA®

MODEL	FROM	TO	TRP TYPE	COMPL. KEYS*
CELSIOR	1998	2004	TEXAS	

TOY41RBR8 3 BUTTONS **52**
See also: TOYOTA® USA, TOYOTA®

MODEL	FROM	TO	TRP TYPE	COMPL. KEYS*
PLATZ	1999	2002	TEXAS	

TOY41RRS2 2 BUTTONS **52**
See also: TOYOTA® USA, TOYOTA®

MODEL	FROM	TO	TRP TYPE	COMPL. KEYS*
PLATZ	1999	2002	TEXAS	

TOY43BRS2 2 BUTTONS **52**
See also: TOYOTA® USA, TOYOTA®

MODEL	FROM	TO	TRP TYPE	COMPL. KEYS*
GAIA	1999	2004	TEXAS	
IPSUM	1996	2003	TEXAS	

TOY43BRS8 3 BUTTONS **53**
See also: TOYOTA® USA, TOYOTA®

MODEL	FROM	TO	TRP TYPE	COMPL. KEYS*
GAIA	1999	2004	TEXAS	
IPSUM	1996	2003	TEXAS	
KLUGER	2003	2007	TEX / CR	

TOY43RS1 1 BUTTON **53**

MODEL	FROM	TO	TRP TYPE	COMPL. KEYS*
CALDINA	2002	2004	TEXAS	
ESTIMA	2001	2003	TEXAS	

TOY43RS2 2 BUTTONS **53**

MODEL	FROM	TO	TRP TYPE	COMPL. KEYS*
CALDINA	2002	2004	TEXAS	
ESTIMA	2001	2003	TEXAS	

TOY48ARS8 3 BUTTONS **54**

MODEL	FROM	TO	TRP TYPE	COMPL. KEYS*
CROWN	2005	2011	TEX / CR	
REIZ	2005	2011	TEX / CR	

TOY48BRS2 2 BUTTONS **54**
See also: LEXUS®, TOYOTA®

MODEL	FROM	TO	TRP TYPE	COMPL. KEYS*
CELSIOR	1998	2004	TEXAS	

TOY48BRS8 3 BUTTONS **54**
See also: LEXUS®, TOYOTA®

MODEL	FROM	TO	TRP TYPE	COMPL. KEYS*
CELSIOR	1998	2004	TEXAS	

TOYRSE2 2 BUTTONS **55**
See also: TOYOTA®

MODEL	FROM	TO	TRP TYPE	COMPL. KEYS*
MARK X	2004	2006	TEX / CR	

TOYRS8 3 BUTTONS **62**
See also: TOYOTA® USA, TOYOTA®

MODEL	FROM	TO	TRP TYPE	COMPL. KEYS*
CELSIOR	1998	2004	TEXAS	
GAIA	1999	2004	TEXAS	
IPSUM	1996	2003	TEXAS	
KLUGER	2003	2007	TEX / CR	
PLATZ	1999	2002	TEXAS	

FOR: TOYOTA® USA

TOY41RBR8 3 BUTTONS **55**
See also: TOYOTA® JAPAN, TOYOTA®

MODEL	FROM	TO	TRP TYPE	COMPL. KEYS*
MR2	2001	2005	TEXAS	

TOY41RRS2 2 BUTTONS **55**
See also: TOYOTA® JAPAN, TOYOTA®

MODEL	FROM	TO	TRP TYPE	COMPL. KEYS*
MR2	2001	2005	TEXAS	

TOY43ARS10 4 BUTTONS **56**

MODEL	FROM	TO	TRP TYPE	COMPL. KEYS*
AVALON	2005	2011	TEX / CR	
CAMRY	2003	2011	TEX / CR	
COROLLA	2005	2010	TEX / CR	
RAV 4	2006	2010	TEX / CR	
VENZA	2009	2010	TEX / CR	
YARIS	2007	2011	TEX / CR	

TOY43ARS2 2 BUTTONS **56**
See also: TOYOTA®

MODEL	FROM	TO	TRP TYPE	COMPL. KEYS*
HIACE	2006	2013	TEX / CR	
HILUX	2004	2012	TEX / CR	

TOY43ARS7 4 BUTTONS **56**
See also: TOYOTA®

MODEL	FROM	TO	TRP TYPE	COMPL. KEYS*
SIENNA	2006	2010	TEX / CR	

TOY43ARS8 3 BUTTONS **57**

MODEL	FROM	TO	TRP TYPE	COMPL. KEYS*
AVALON	2005	2011	TEX / CR	
CAMRY	2003	2011	TEX / CR	

* COMPL. KEYS = COMPLEMENTARY KEYS

COROLLA 2005 2010 TEX / CR

TOY43ARS9 3 BUTTONS **57**

MODEL	FROM	TO	TRP TYPE	COMPL. KEYS*
AVALON	2005	2011	TEX / CR	
CAMRY	2003	2011	TEX / CR	
COROLLA	2005	2010	TEX / CR	

TOY43BRS2 2 BUTTONS **57**

See also: TOYOTA® JAPAN, TOYOTA®

MODEL	FROM	TO	TRP TYPE	COMPL. KEYS*
4RUNNER	1999	2002	TEXAS	
4RUNNER	2003	2010	TEX / CR	
AVALON	1998	2005	TEXAS	
CAMRY	1998	2004	TEXAS	
HIGHLANDER	2001	2003	TEXAS	
HIGHLANDER	2004	2010	TEX / CR	
LAND CRUISER	1998	2002	TEXAS	
LAND CRUISER	2003	2008	TEX / CR	
RAV 4	2004	2006	TEX / CR	
SEQUOIA	2001	2002	TEXAS	
SEQUOIA	2003	2010	TEX / CR	
SIENNA	1999	2003	TEXAS	
SIENNA	2004	2008	TEX / CR	
SOLARA	2002	2003	TEXAS	
SOLARA	2004	2010	TEX / CR	

TOY43BRS8 3 BUTTONS **58**

See also: TOYOTA® JAPAN, TOYOTA®

MODEL	FROM	TO	TRP TYPE	COMPL. KEYS*
4RUNNER	1999	2002	TEXAS	
4RUNNER	2003	2010	TEX / CR	
AVALON	1998	2005	TEXAS	
CAMRY	1998	2004	TEXAS	
HIGHLANDER	2001	2003	TEXAS	
HIGHLANDER	2004	2010	TEX / CR	
LAND CRUISER	1998	2002	TEXAS	
LAND CRUISER	2003	2008	TEX / CR	
RAV 4	2004	2006	TEX / CR	
SEQUOIA	2001	2002	TEXAS	
SEQUOIA	2003	2010	TEX / CR	
SIENNA	1999	2003	TEXAS	
SIENNA	2004	2008	TEX / CR	
SOLARA	2002	2003	TEXAS	
SOLARA	2004	2010	TEX / CR	

TOYRS8 3 BUTTONS **62**

See also: TOYOTA® JAPAN, TOYOTA®

MODEL	FROM	TO	TRP TYPE	COMPL. KEYS*
4RUNNER	1999	2002	TEXAS	
4RUNNER	2003	2010	TEX / CR	
AVALON	1998	2005	TEXAS	
CAMRY	1998	2004	TEXAS	
HIGHLANDER	2001	2003	TEXAS	

HIGHLANDER	2004	2010	TEX / CR	
LAND CRUISER	1998	2002	TEXAS	
LAND CRUISER	2003	2008	TEX / CR	
MR2	2001	2005	TEXAS	
RAV 4	2004	2006	TEX / CR	
SEQUOIA	2001	2002	TEXAS	
SEQUOIA	2003	2010	TEX / CR	
SIENNA	1999	2003	TEXAS	
SIENNA	2004	2008	TEX / CR	
SOLARA	2002	2003	TEXAS	
SOLARA	2004	2010	TEX / CR	

FOR: VOLKSWAGEN®

HU66APRS **58**

See also: AUDI®

MODEL	FROM	TO	TRP TYPE	COMPL. KEYS*
BEETLE	1999	2003	MEG / CR	

HU66BRS8 3 BUTTONS **58**

See also: SEAT®, SKODA®

MODEL	FROM	TO	TRP TYPE	COMPL. KEYS*
BEETLE	2011	2013	MEG / CR	
BEETLE	2014	2016	MEG / CR2	
CADDY	2011	2016	MEG / CR	
EOS	2010	2015	MEG / CR	
GOLF	2009	2012	MEG / CR	
JETTA	2010	2012	MEG / CR	
JETTA	2012	2016	MEG / CR2	
POLO	2009	2014	MEG / CR	
SCIROCCO	2008	2014	MEG / CR	
SHARAN	2010	2015	MEG / CR	
TIGUAN	2010	2015	MEG / CR	
TOURAN	2009	2012	MEG / CR	
TRANSPORTER	2009	2012	MEG / CR	
UP!	2012	2015	MEG / CR	

HU66PRS **59**

See also: SEAT®, SKODA®

MODEL	FROM	TO	TRP TYPE	COMPL. KEYS*
BEETLE	2003	2011	MEG / CR	
BEETLE	2003	2011	MEG / CR	
CADDY	2004	2010	MEG / CR	
CROSS GOLF	2006	2007	MEG / CR	
EOS	2006	2009	MEG / CR	
GOLF	2004	2008	MEG / CR	
INDIVIDUAL	2004	2008	MEG / CR	
JETTA	2004	2009	MEG / CR	
PASSAT	2004	2005	MEG / CR	
SCIROCCO	2008	2014	MEG / CR	
TIGUAN	2007	2009	MEG / CR	
TOURAN	2003	2009	MEG / CR	

* COMPL. KEYS = COMPLEMENTARY KEYS



General Index

HURSA2 2 BUTTONS **59**

See also: SEAT®, SKODA®

MODEL	FROM	TO	TRP TYPE	COMPL. KEYS*
CROSS GOLF	2006	2007	MEG / CR	HU66PRS
EOS	2006	2009	MEG / CR	HU66PRS
GOLF	2004	2008	MEG / CR	HU66PRS
INDIVIDUAL	2004	2008	MEG / CR	HU66PRS
JETTA	2004	2009	MEG / CR	HU66PRS
PASSAT	2004	2005	MEG / CR	HU66PRS
TOURAN	2003	2009	MEG / CR	HU66PRS

HURSA8 3 BUTTONS **59**

See also: SEAT®, SKODA®

MODEL	FROM	TO	TRP TYPE	COMPL. KEYS*
BEETLE	2003	2011	MEG / CR	HU66PRS
BEETLE	2003	2011	MEG / CR	HU66PRS
CADDY	2004	2010	MEG / CR	HU66PRS
CROSS GOLF	2006	2007	MEG / CR	HU66PRS
EOS	2006	2009	MEG / CR	HU66PRS
GOLF	2004	2008	MEG / CR	HU66PRS
INDIVIDUAL	2004	2008	MEG / CR	HU66PRS
JETTA	2004	2009	MEG / CR	HU66PRS
PASSAT	2004	2005	MEG / CR	HU66PRS
TOURAN	2003	2009	MEG / CR	HU66PRS

HURSB8 3 BUTTONS **60**

See also: AUDI®

MODEL	FROM	TO	TRP TYPE	COMPL. KEYS*
BEETLE	1999	2003	MEG / CR	HU66APRS

* **COMPL. KEYS = COMPLEMENTARY KEYS**



Legal Notes

EN - In compliance with current regulations relating to industrial property, we hereby state that the trade-marks or trade names mentioned in this document are the exclusive property of authorized manufacturers of locks and users. Said trade-marks or trade names are nominated only for the purposes of information so that any lock for which our keys are made can be rapidly identified. This document is reserved exclusively for professional key cutters who use Silca products. / All information and illustrations in this document are for guidance only. Silca reserves the right to alter products designs, dimensions or info to improve the products quality. The contents of this document are fully protected by Copyright and may not be copied or reproduced in any form, without written permission from Silca S.p.A. Any controversy shall be settled by the Courts of Justice where the company Silca S.p.A. has its headquarters, with express exclusion of any other court.

IT - In conformità alle disposizioni legali in vigore relative alle proprietà industriali, informiamo che i marchi o le denominazioni commerciali citate nel nostro documento sono di proprietà esclusiva dei fabbricanti di serrature e degli utilizzatori autorizzati. Questi marchi o denominazioni commerciali sono indicati a titolo di semplice informazione, con lo scopo di riconoscere velocemente a quali serrature le nostre chiavi sono destinate. Questo documento è esclusivamente riservato ai professionisti della riproduzione chiavi che utilizzano i prodotti Silca. / Le illustrazioni e i dati tecnici dei prodotti contenuti nel documento debbono considerarsi indicativi. Silca si riserva il diritto, ferme restando le caratteristiche essenziali dei prodotti, di apportare tutte le modifiche che ritiene necessarie e opportune al fine di migliorare la qualità dei prodotti. Tutti i disegni e le fotografie sono di proprietà di Silca, ogni riproduzione anche parziale, senza autorizzazione scritta di Silca S.p.A. è vietata secondo termini di legge. Per qualsiasi controversia competenti sono gli Uffici Giudiziari dove ha sede l'Azienda Silca S.p.A., con espressa esclusione di qualsiasi altro foro.

DE - Gemäß den derzeit geltenden Normen bezüglich des Industrieigentums teilen wir Ihnen mit, dass die in der vorliegenden Dokumentation angeführten Markennamen oder Handelsmarken ausschließliches Eigentum der Schlosshersteller und zugelassenen Fachhändler sind. Diese Markenbezeichnungen oder Handelsmarken sind nur zur Information angeführt, mit dem Zweck, schnell erkennen zu können, zu welchem Schloss unsere Schlüssel gehören. Die vorliegende Broschüre ist ausschließlich an Fachgeschäfte gerichtet, die Silca Produkte einsetzen. / Die Abbildungen und technischen Daten in dieser Broschüre sind nur zur Information. Silca behält sich vor, etwaige Änderungen, die zur Verbesserung des Produktes beitragen, vorzunehmen. Alle Zeichnungen und Fotos sind Eigentum der Firma Silca. Jede Reproduktion, auch teilweise, ist ohne ausdrückliche Genehmigung der Silca S.p.A. gesetzlich untersagt. Im Falle von Streitfragen ist der Gerichtsstand des Firmensitzes Silca S.p.A. zuständig; jeder andere Gerichtsstand ist ausgeschlossen.

FR - Conformément aux lois en vigueur concernant la propriété industrielle, nous vous informons que les marques et appellations commerciales citées dans notre documentation appartiennent exclusivement aux fabricants de serrures et aux utilisateurs autorisés. Ces marques ou appellations commerciales sont indiquées à titre d'information pure et simple pour vous permettre de déterminer rapidement les serrures auxquelles nos clés sont destinées. Cette documentation est réservée exclusivement aux professionnels du taillage de clés qui utilisent les produits Silca. / Les illustrations et les caractéristiques techniques des produits présentés dans cette documentation sont données à titre indicatif. Bien que les caractéristiques essentielles des produits soient invariables, Silca se réserve le droit d'apporter toutes les modifications qu'elle retiendra nécessaires et opportunes afin d'améliorer la qualité de ses produits. Tous les dessins et photos sont propriété Silca et toute reproduction, même partielle, sans l'autorisation écrite préalable de Silca S.p.A. est interdite conformément aux prescriptions légales. Tout litige est du ressort exclusif des Tribunaux de la circonscription où se trouve le Siège de la Société Silca S.p.A.



Legal Notes

ES - En conformidad con las vigentes disposiciones de ley sobre propiedad industrial, las marcas y denominaciones comerciales citadas en nuestra documentación se declaran de propiedad exclusiva de los fabricantes de cerraduras y los utilizadores autorizados. Dichas marcas o denominaciones comerciales se citan por simple información, al objeto de hacer comprender sin dificultad a qué cerraduras van destinadas nuestras llaves. Esta documentación está reservada exclusivamente a los profesionales de la reproducción de llaves que utilizan los productos Silca. / Las ilustraciones y los datos técnicos de los productos en esta documentación son indicativos. Silca se reserva el derecho, quedando invariables las características principales de los productos, de modificar todo lo que considere necesario y oportuno para mejorar la calidad de sus artículos. Todos los dibujos y fotografías pertenecen a Silca; según determina la Ley, se prohíbe toda reproducción, total o parcial, sin autorización por escrito de Silca S.p.A. En caso de disconformidad, la competencia es de las autoridades judiciales donde esté domiciliada la firma Silca S.p.A. excluyendo cualquier otro Tribunal.

PT - Em conformidade com as disposições legais em vigor relativas à propriedade industrial, informamos que as marcas ou as denominações comerciais citadas no nossa documentação são propriedade exclusiva dos fabricantes de fechaduras e dos utilizadores autorizados. Estas marcas ou denominações comerciais são indicadas só a nível de informação, a fim de reconhecer rapidamente a quais fechaduras se destinam as nossas chaves. Esta documentação é reservada exclusivamente aos profissionais da reprodução de chaves que utilizam os produtos Silca. / As ilustrações e as características técnicas dos produtos apresentados neste catálogo são facultados a título indicativo. Mesmo que as características essenciais dos produtos sejam invariáveis, à Silca reserva-se o direito de modificar ser necessário e oportuno los productos, afim de melhorar a sua qualidade. Todos os desenhos e fotos são propriedade da Silca, e é proibida a sua reprodução mesmo parcial sem a autorização escrita da Silca S.p.A. conforme as prescrições legais. Em caso de litígio fica desde já designado, excluindo qualquer outro, o Tribunal da comarca onde está registrada a sede da Silca S.p.A.

NL - Graag vestigen wij de aandacht op het feit dat, in overeenstemming met de wettelijke beschikkingen die van kracht zijn inzake industriële eigendommen, de in dit document geciteerde merken en commerciële benamingen exclusieve eigendom zijn van de betreffende slotenfabrikanten en geautoriseerde gebruikers. Deze commerciële benamingen en merken worden zuiver informatief vermeld, met enkel als doel de sloten waarvoor onze sleutels geschikt zijn sneller te identificeren. Dit document is uitsluitend voorbehouden aan gespecialiseerde sleutelmakers die Silca producten gebruiken. / De illustraties en technische gegevens van de producten vermeld in dit document zijn louter illustratief en derhalve benaderend. Silca behoudt zich het recht voor om, mits behoud van de essentiële eigenschappen van haar producten, alle wijzigingen uit te voeren die zij nodig en opportuun acht ter verbetering van de productkwaliteit. Alle tekeningen en foto's zijn eigendom van Silca. Elke volledige of gedeeltelijke reproductie zonder schriftelijke toestemming van Silca S.p.A. is wettelijk verboden. Voor eventuele twisten is uitsluitend de Rechtbank van de plaats waar het bedrijf zijn zetel heeft bevoegd. Alle andere rechtbanken worden uitgesloten.

ITALY

SILCA S.p.A.

Via Podgora, 20 (Z.I.)
31029 VITTORIO VENETO (TV)
Tel. +39 0438 9136
Fax +39 0438 913800
silca@silca.it
www.silca.biz - www.silca.it

GERMANY

SILCA GmbH

Siemensstrasse, 33
42551 VELBERT
Phone +49 2051 2710
Fax +49 2051 271172
info@silca.de
www.silca.de

UNITED KINGDOM

SILCA Ltd.

Unit 6 Lloyds Court
Manor Royal
CRAWLEY RH10 9QU
Phone +44 1293 531134
Fax +44 1293 531108
sales@silcald.co.uk
www.silcald.co.uk

SPAIN

SILCA KEY SYSTEMS S.A.

C/Santander 73A
08020 BARCELONA
Phone +34 93 4981400
Fax +34 93 2788004
silca@silca.es
www.silca.es

FRANCE

SILCA S.A.S.

12, Rue de Rouen
Z.I. Limay-Porcheville
78440 PORCHEVILLE
Phone +33 1 30983500
Fax +33 1 30983501
info@silca.fr
www.silca.fr

BENELUX

H. CILLEKENS & B.V.

Metaalweg, 4
6045 JB ROERMOND
Phone +31 475 325147
Fax +31 475 323640
info@hcillekens.nl
www.hcillekens.nl

UNITED KINGDOM

ADVANCED DIAGNOSTICS Ltd.

Eastboro Fields
Hemdale Business Park
CV11 6GL Nuneaton
Phone +44 2476 347000
Fax + 44 2476 347100
sales@advanced-diagnostics.com
www.advanced-diagnostics.com

UNITED STATES

KABA ILCO CORP.

400 Jeffreys Road
Rocky Mount, NC 27804
Phone 1-252-446-3321
Fax 1-252-446-4702
info.ilco@kaba.com
www.ilco.us



dormakaba Group



NETWORK WITH US