

109



109

Catalogue for household and commercial flat,
dimple, cruciform, mail box and
other special keys

Catalogo chiavi piatte per serrature a cilindro,
chiavi punzionate, a croce, per ascensori
e casellari postali

Flach-, Kreuzbart- und Bormuldenschlüssel,
Lift- und Fachkastenschlüssel Katalog

Catalogue clés plates pour cylindres,
clés à points, clés cruciformes, clés pour
ascenseurs et casiers

Catálogo llaves planas para cilindro,
llaves de seguridad, llaves en cruz, llaves
para ascensores y casilleros postales

Catálogo das chaves planas para fechaduras
de cilindro, chaves de ponto, chaves tetra,
chaves para elevadores e caixas de correio





IV	Silca Website	IV	Sito internet Silca	IV	Silca Webseite
V	The Online Catalogue and MySica App	V	Catalogo Online e MySilca App	V	Online-Katalog und MySilca App
VI	Silky	VI	Silky	VI	Silky
VII	Art Keys	VII	Art Keys	VII	Art Keys
VIII	Ultralite	VIII	Ultralite	VIII	Ultralite
IX	Slim Color	IX	Slim Color	IX	Slim Color
X	Terminology	X	Terminologia	X	Terminologie
XII	Key Identification	XII	Identificazione Chiave	XII	Schlüsselidentifikation
XIV	Technical Information	XIV	Informazioni Tecniche	XIV	Technische Auskünfte
XVIII	Uses	XVIII	Utilizzi	XVIII	Verwendungen
XX	'Serie Distinzione' Heads	XX	Teste 'Serie Distinzione'	XX	Schlüsselköpfe der 'Serie Distinzione'
XXVIII	'Serie Distinzione' Slim Color	XXVIII	'Serie Distinzione' Slim Color	XXVIII	'Serie Distinzione' Slim Color
XXX	'Serie Distinzione' Color	XXX	'Serie Distinzione' Color	XXX	'Serie Distinzione' Color
3	Household Keys	3	Chiavi Piatte	3	Flachschlüssel
225	Dimple Keys	225	Chiavi Punzonate	225	Bohrmuldenschlüssel
253	Cruciform keys	253	Chiavi a Croce	253	Kreuzbartschlüssel
269	Mail Box and Lift Keys	269	Chiavi per Casellari e Ascensori	269	Fachkästen- und Liftschlüssel
276	General Index	276	Indice Generale	276	Generalverzeichnis



IV	Site Internet Silca	IV	Sitio Internet Silca	IV	Site Internet Silca
V	Catalogue Online et MySilca App	V	Catálogo Online y MySilca App	V	Catálogo Online e MySilca App
VI	Silky	VI	Silky	VI	Silky
VII	Art Keys	VII	Art Keys	VII	Art Keys
VIII	Ultralite	VIII	Ultralite	VIII	Ultralite
IX	Slim Color	IX	Slim Color	IX	Slim Color
X	Terminologie	X	Terminología	X	Terminologia
XII	Identification Clé	XII	Identificación de la Llave	XII	Identificação de uma Chave
XIV	Informations Techniques	XIV	Informaciones Técnicas	XIV	Informações Técnicas
XVIII	Utilisations	XVIII	Utilizaciones	XVIII	Utilizações
XX	Têtes 'Serie Distinzione'	XX	Cabezas 'Serie Distinzione'	XX	Cabeças 'Serie Distinzione'
XXVIII	'Serie Distinzione' Slim Color	XXVIII	'Serie Distinzione' Slim Color	XXVIII	'Serie Distinzione' Slim Color
XXX	'Serie Distinzione' Color	XXX	'Serie Distinzione' Color	XXX	'Serie Distinzione' Color
3	Clés Plates	3	Llaves Planas	3	Chaves Planas
225	Clés à Points	225	Llaves de Seguridad	225	Chaves de Pontos
253	Clés Cruciformes	253	Llaves en Cruz	253	Chaves Tetra
269	Clés pour Casiers et Ascenseurs	269	Llaves para Casillas y Ascensores	269	Chaves para Caixas de Correio e Elevadores
276	Index Général	276	Indice General	276	Índice Geral



Silca Website

EN - Contains complete information on all Silca products including keys, key cutting machines, automotive solutions and complementary products. Find out the latest news on support tools and accessories; download brochures and keep your 109 catalogue updated with the Silca New Key Collection; all at www.silca.biz.

IT - Tutte le informazioni sui prodotti Silca - chiavi e macchine duplicatrici, soluzioni automotive e prodotti complementari - sono facilmente consultabili all'interno del sito www.silca.biz. Potrai inoltre scaricare mensilmente i Bollettini Silca News e la Raccolta Nuove Chiavi Silca da allegare al catalogo 109 e tenerlo sempre aggiornato.

DE - Alle Informationen zu den Silca-Produkten - Schlüssel und Schlüsselfräsmaschinen, Lösungen für Fahrzeugschlüssel - sind einfach über die Internetseite www.silca.biz abzurufen. Außerdem haben Sie die Möglichkeit, monatlich die Silca News und die Sammlung der neuen Silca-Schlüssel herunterzuladen, mit dem Sie den Katalog 109 ergänzen und aktualisieren können.

FR - Toutes les informations sur les produits Silca - clés et machines à reproduire les clés, solutions automotive et produits complémentaires - sont facilement consultables sur notre site www.silca.biz. Vous pourrez en outre télécharger tous les mois nos Bulletins Silca News et la Collection Nouvelles Clés Silca à annexer au catalogue 109 pour qu'il soit ainsi toujours à jour.

ES - Toda la información sobre los productos Silca - llaves y duplicadoras, soluciones automotive y productos complementarios - se puede consultar fácilmente entrando en el sitio www.silca.biz. Asimismo, podrás bajarte mensualmente los Boletines Silca News y la Colección Nuevas Llaves Silca, que adjuntar al catálogo 109, para mantenerlo siempre al día.

PT - Todas as informações sobre os produtos Silca - chaves e máquinas duplicadoras, soluções automotive e produtos complementares - podem ser consultadas facilmente no site www.silca.biz. Também poderá descarregar mensalmente os Boletins Silca News e a Coleção Novas Chaves Silca a anexar ao catálogo 109 para o manter sempre atualizado.

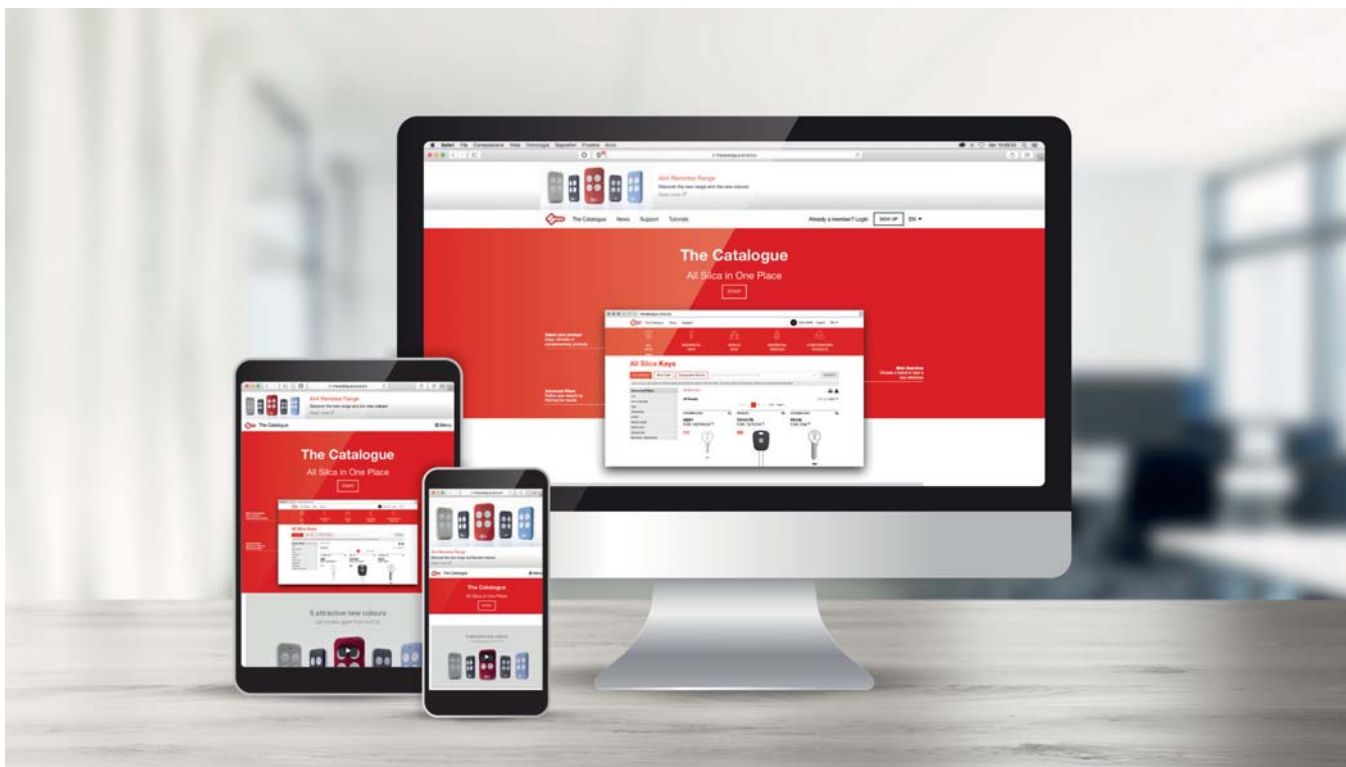

The Online Catalogue and MySilca App

EN - The world's most complete database for all types of keys whether residential, commercial or automotive. The breadth and quality of the information available make this the essential tool to find the key you need. Register at thecatalogue.silca.biz.

Install the free MySilca App on your mobile and have all the essential Silca information at your fingertips, whenever and wherever you need it.

FR - The Catalogue est le data base le plus complet de clés résidentielles et automotive au monde. La quantité et la qualité des informations qu'il contient en font un instrument essentiel pour repérer facilement n'importe quel type de clé. Enregistrez-vous sur thecatalogue.silca.biz.

Installez l'app gratuite MySilca et vous aurez toutes les informations nécessaires indispensables à votre travail toujours et partout.

IT - The Catalogue è il più completo database di chiavi ad uso residenziale e automotive al mondo. La quantità e la qualità delle informazioni in esso contenute lo rendono lo strumento essenziale per individuare facilmente qualsiasi tipologia di chiave. Registrati su thecatalogue.silca.biz.

Installa l'app gratuita MySilca e avrai tutte le informazioni necessarie a svolgere il tuo lavoro a portata di mano, in qualsiasi momento, ovunque tu sia.

ES - The Catalogue es la base de datos más completa de llaves para el uso residencial y el sector automovilístico del mundo entero. Por la cantidad y la calidad de la información contenida en ésta, es una herramienta esencial para identificar fácilmente una tipología de llave. Regístrate en thecatalogue.silca.biz.

Instala la app gratis MySilca para tener al alcance toda la información necesaria para desarrollar tu trabajo en todo momento y en todos lados.

DE - The Catalogue ist die weltweit umfassendste Datenbank für Wohn- und Fahrzeugschlüssel. Die Menge und die Qualität der in der Datenbank enthaltenen Informationen machen sie zu einem wesentlichen Instrument, um jede Art von Schlüssel einfach zu erkennen. Melden Sie sich auf thecatalogue.silca.biz an.

Installieren Sie die kostenlose App MySilca, damit Sie jederzeit und überall alle für Ihre Arbeit erforderlichen Informationen bei der Hand haben.

PT - The Catalogue é o banco de dados mais completo no mundo para chaves de utilização residencial e automotive. A quantidade e a qualidade das informações nele contidas tornam-no no instrumento essencial para individualizar facilmente qualquer tipo de chave. Registe-se em thecatalogue.silca.biz.

Instale a app gratuita MySilca e terá ao alcance da mão todas as informações para realizar o seu trabalho, em qualquer momento, em qualquer lugar se encontre.



AVAILABLE COLOURS:



Silky

EN - Combining design and quality, Silky keys are available for a wide range of popular references, including both flat and dimple key types. Choose from five different colours; green, blue, pink, red and orange. Silky keys can be customized on request. Check the 109 Index on page 276 to see which key references are available with the Silky head.

IT - Le chiavi Silky coniugano design e qualità e sono disponibili per un'ampia gamma di referenze chiavi fra le più comuni, sia piatte che punzonate. È possibile scegliere fra cinque colori standard: verde, blu, rosa, rosso e arancione. La chiavi Silky possono essere personalizzate su richiesta. Consulta l'Indice a pagina 276 per conoscere tutti gli articoli disponibili nella finitura Silky.

DE - Die Silky-Schlüssel verbinden Design und Qualität und sind in einer breiten Palette für die am häufigsten verwendeten Referenzschlüssel erhältlich, sowohl für Flach- als auch für Bohrmuldenschlüssel. Zur Auswahl stehen fünf Standardfarben: grün, blau, rosa, rot und orange. Die Silky-Schlüssel können auf Anfrage personalisiert werden. Sehen Sie im Verzeichnis auf Seite 276 nach, welche Artikel in der Silky-Version erhältlich sind.

FR - Les clés Silky allient design et qualité et sont proposées dans une vaste gamme, à savoir les clés les plus communes plates et à points. Disponible en cinq couleurs standard : vert, bleu, rose, rouge et orange. Les clés Silky sont personnalisables sur demande. Voir la Table des Matières page 276 pour découvrir tous les articles proposés en finition Silky.

ES - Las llaves Silky conjugan diseño y calidad y están disponibles en una gama amplia de referencias de llaves entre las más comunes, ya sean planas o punzonadas. Se puede elegir entre cinco colores estándares: verde, azul, rosa, rojo y naranja. Las llaves Silky se pueden personalizar bajo pedido. Consulta el índice de la página 276 para ver todos los artículos disponibles con el acabado Silky.

PT - As chaves Silky conjugam design e qualidade e estão disponíveis numa ampla gama de referências chave entre as mais comuns, planas e de pontos. É possível escolher entre cinco cores: verde, azul, cor-de-rosa, vermelho e laranja. As chaves Silky também podem ser personalizadas por encomenda. Consulte o Índice na página 276 para conhecer todos os artigos disponíveis no acabamento Silky.



Art Keys

EN - Creative and colourful the Silca Art Keys range includes fresh patterns like fruit, flowers, flamingos and cakes and themes that stretch from the wild west to the street art world. Silca Art Keys are made to the highest quality standards guaranteed by Silca and have a finish that stays looking new.

IT - Divertenti e variopinte le chiavi Silca Art Keys renderanno unico e inconfondibile il mazzo di chiavi dei tuoi clienti. Ispirate alle fantasie dei fumetti e dei graffiti, al mondo degli animali e ai soggetti di tendenza del momento, le chiavi Art sono realizzate secondo gli elevati standard di produzione Silca, garantendo nel tempo la qualità della finitura.

DE - Die witzigen und bunten Silca Schlüssel Art Keys sorgen für einen einzigartigen und unverwechselbaren Schlüsselbund Ihrer Kunden. Die Art Keys, die von den Motiven der Comics und der Graffiti, der Tierwelt und im Trend liegenden Motiven inspiriert sind, werden gemäß den hohen Produktionsstandards von Silca gefertigt, wodurch eine langanhaltende Qualität der Endbearbeitung garantiert wird.

FR - Amusantes et bariolées, les clés Silca Art Keys rendront unique et incomparable le trousseau de clés de vos clients. S'inspirant à l'imagination des BD et des graffitis, au monde animal et aux sujets tendance du moment, les clés Art sont fabriquées selon les hauts standards de production Silca, donc la qualité des finitions est garantie dans le temps.

ES - Con las llaves Silca Art Keys, divertidas y variopintas, los llaveros de llaves de tus clientes serán únicos e inconfundibles. Las llaves Art, inspiradas en las fantasías de los dibujos animados y de los grafitos, en el mundo de los animales y en los personajes y temas de moda, están realizadas en cumplimiento de estándares elevados de producción Silca, para garantizar la calidad del acabado a largo plazo.

PT - Divertidas e coloridas, as chaves Silca Art Keys tornarão único e inconfundível o molho de chaves dos seus clientes. Inspiradas nas fantasias das bandas desenhadas e dos graffiti, no mundo dos animais e nos padrões na moda, as chaves Art são realizadas de acordo com os elevados níveis de produção Silca, garantindo a qualidade do acabamento ao longo do tempo.



AVAILABLE COLOURS:



Ultralite

EN - Silca Ultralite Keys are made of a special aluminium alloy, chosen because of its combination of lightness and strength; in fact, so strong and light that it's widely used in the aerospace industry. Seven colours are available: red, green, blue, yellow, black, sky blue, violet. In the 109 catalogue Ultralite keys are identified on page 276.

IT - Le chiavi Silca Ultralite sono realizzate con una speciale lega di alluminio che unisce leggerezza e resistenza. Il materiale con cui sono prodotte è infatti largamente impiegato nell'industria automobilistica, aeronautica e ferroviaria. Le chiavi Ultralite sono disponibili in sette colori (rosso, verde, blu, giallo, nero, azzurro, viola) nelle referenze indicate a pagina 276.

DE - Die Silca Ultralite-Schlüssel werden aus einer speziellen Aluminiumlegierung gefertigt, die sich durch Widerstandsfähigkeit und Leichtigkeit auszeichnet. Das Material, aus dem sie produziert werden, kommt viel in der Automobil-, Luftfahrt und Eisenbahnindustrie zum Einsatz. Die Ultralite-Schlüssel sind in sieben verschiedenen Farben (rot, grün, blau, gelb, schwarz, hellblau, violett) in den auf Seite 276 angegebenen Referenzen lieferbar.

FR - Les clés Silca Ultralite sont fabriquées dans un alliage d'aluminium spécial qui unit légèreté et résistance. Ce matériau est d'ailleurs largement utilisé dans l'industrie automobile, aéronautique et ferroviaire. Les clés Ultralite sont proposées en 7 couleurs (rouge, vert, bleu, jaune noir, bleu-ciel, violet) dans les articles indiqués page 276.

ES - Las llaves Silca Ultralite están realizadas con una aleación especial de aluminio, que conjuga ligereza y resistencia. De hecho, el material de producción se emplea ampliamente en la industria automovilística, aeronáutica y ferroviaria. Las llaves Ultralite están disponibles en siete colores) en las referencias indicadas en la página 276.

PT - As chaves Silca Ultralite são realizadas com uma liga de alumínio especial que une ligeireza e resistência. O material com que são produzidas, de facto, é muito utilizado na indústria automobilística, aeronáutica e ferroviária. As chaves Ultralite estão disponíveis em sete cores (vermelho, verde, azul, amarelo, preto, azul, violeta) nas referências indicadas na página 276.



AVAILABLE COLOURS:



Slim color

EN - The range of 5 colours help your customers easily identify their key without having the inconvenience of a bulkier product. Silca Slim Color keys are made in the most common flat and dimple key references and can be ordered in different head shapes, as indicated on page XXVIII. See which key references are available in Slim Color in the Index on page 276.

IT - Questa serie, disponibile in cinque colori, aiuterà i tuoi clienti ad identificare agevolmente chiavi con utilizzi diversi. Le chiavi Silca Slim Color sono disponibili per un'ampia gamma di chiavi piatte e punzonate. Possono avere forme diverse della testa, come indicato a pagina XXVIII. Scopri per quali chiavi è disponibile questa finitura nell'Indice a pagina 276.

DE - Diese Serie, die in fünf Farben lieferbar ist, hilft Ihren Kunden, verschiedene Schlüssel untereinander einfach zu unterscheiden. Die Slim-Color-Schlüssel sind für eine breite Palette an Flach- und Bohrmuldenschlüssel erhältlich. Es sind auch verschiedene Kopfformen möglich, siehe hierzu Angaben auf Seite XXVIII. Sehen Sie auf Seite 276 nach, für welche Schlüssel diese Endbearbeitung erhältlich ist.

FR - Série proposée en cinq couleurs qui aidera vos clients à identifier sans problème les clés selon l'usage. Les clés Silca Slim Color sont disponibles dans une vaste gamme de clés plates et à points. La forme de leurs têtes peut différer comme indiqué page XXVIII. Découvrez les clés disponibles dans cette finition dans la Table des Matières page 276.

ES - Esta serie, disponible en cinco colores, ayudará a tus clientes a identificar fácilmente llaves con usos distintos. Las llaves Slim Color están disponibles para una gama amplia de llaves planas y de seguridad. La cabeza puede presentar formas distintas como se indica en la página XXVIII. Descubre en el índice de la página 276 para qué llaves está disponible este acabado.

PT - Esta série, disponível em cinco cores, auxiliará os seus clientes a identificar facilmente chaves com utilizações diferentes. As chaves Silca Slim Color estão disponíveis para uma ampla gama de chaves planas e de pontos. Podem ter formas da cabeça diferentes, como indicado na página XXVIII. Descubra para quais chaves está disponível este acabamento no Índice da página 276.

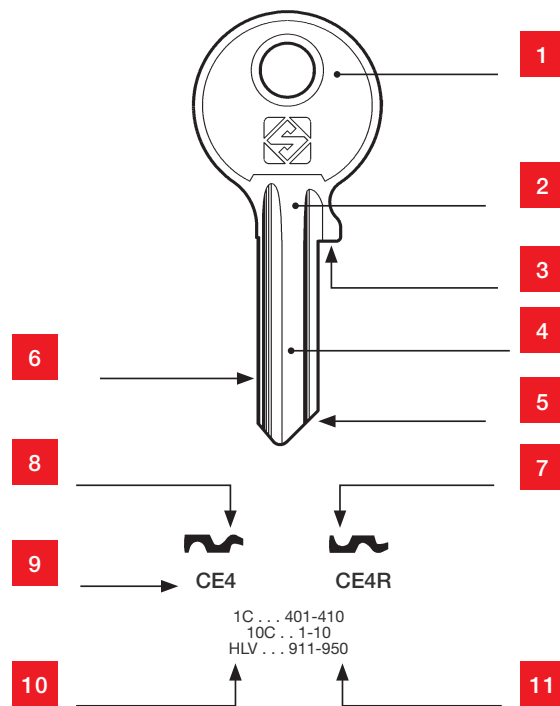

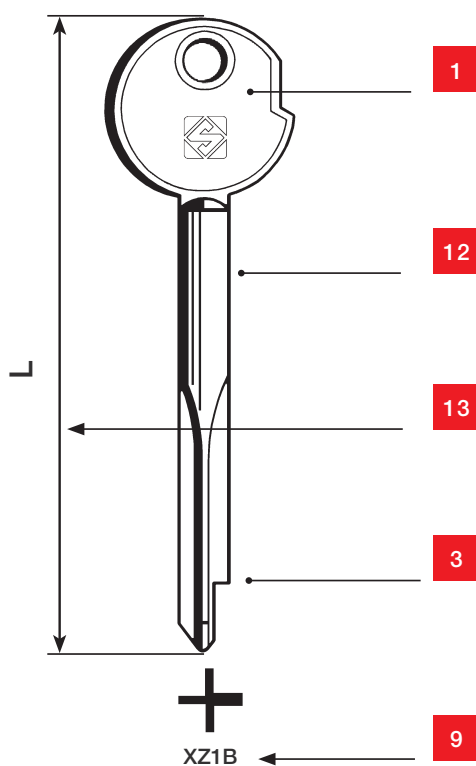

1	Head	Testa	Kopf
2	Neck	Collo	Hals
3	Shoulder	Fermo	Anschlag
4	Blade (stem)	Canna	Stange
5	Tip	Punta	Spitze
6	Back	Dorso	Rücken
7	Left hand profile	Profilo sinistro	Linkes Profil
8	Right hand profile	Profilo destro	Rechtes Profil
9	Silca item	Art. Silca	Silca-Artikel
10	Original profile	Profilo originale	Originalprofil
11	Code	Serie	Serie
12	Stem	Gambo	Halm
13	Length	Lunghezza	Nötige Länge



Tête	Cabeza	Cabeça	1
Cou	Cuello	Colo	2
Arrêt	Tope	Encosto	3
Canon	Caña	Cana	4
Pointe	Punta	Ponta	5
Dos	Dorso	Dorso	6
Profil gauche	Perfil izquierdo	Perfil esquerdo	7
Profil droit	Perfil derecho	Perfil direito	8
Article silca	Artículo silca	Artigo silca	9
Profil original	Perfil original	Perfil original	10
Code	Serie	Códigos	11
Canon	Pala	Haste	12
Longueur	Longitud	Comprimento	13

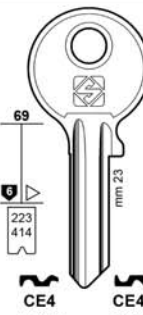
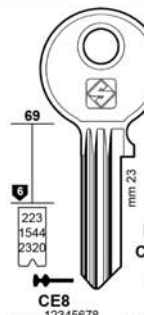
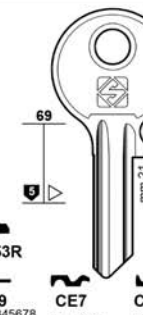
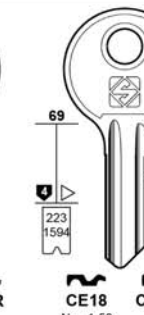

PER: FOR: **CES**

 255 mm 27,5 CE147	 69 mm 23 CE4	 69 mm 23 CE8	 69 mm 21 CE9	 69 mm 18 CE18
CE6 ELZETT FRECOV HÄFELE HANNO JOSTA KARDEX KIND KNAPP MAUSER NEMEF OJMAR VOKO WASO WECO	CE6R BODA ELZETT FRECOV KNAPP	CE4R BODA ELZETT FRECOV KNAPP	CE153R CE9 FRECOV HÄFELE HANNO JOSTA KARDEX KIND KNAPP MAUSER NEMEF OJMAR VOKO WASO WECO	CE7R BODA FRECOV KNAPP OJMAR



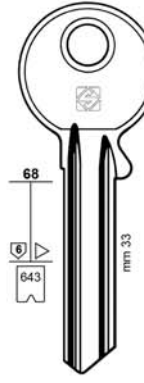
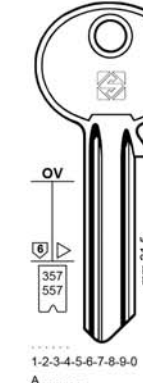

47

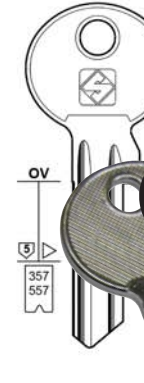
PER: FOR: **CES**

 68 mm 33 CE3	 OV mm 31,5 CE1	 OV mm 28 CE5	 OV mm 28 CE2
CE3R 1-2-3-4-5-6-7-8-9-0 BODA	CE1R FUHR GIESCHE HÖHRMANN KIMA NEMEF SIEBAU SOLID SS STUV	CE1R SOLID	CE2R SOLID TORE TRITON

1-2-3-4-5-6-7-8-9-0
BB 1-12000
BBF 1-12000
BT 1-12000
TS 1-12000

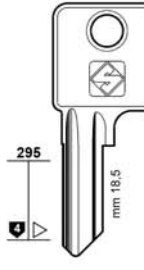
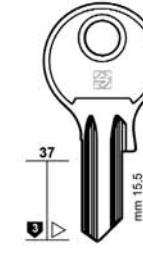
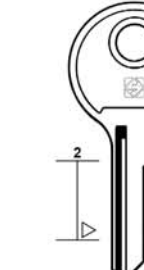
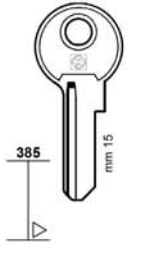
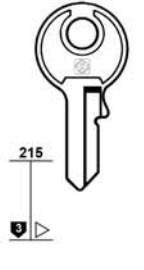

PER: FOR: **CES**

 295 mm 18,5 CE33	 37 mm 15,5 CE13	 2 mm 15 CE11	 385 mm 15 CE19	 215 mm 15 CE30
CE13R ELZETT FRECOV HÄFELE HANNO JOSTA KARDEX KIND KNAPP MAUSER NEMEF OJMAR VOKO WASO	CE11R BOTT	CE19R	CE30R	



Copyright by Silca S.p.A. 2018 - All Rights Reserved

XII

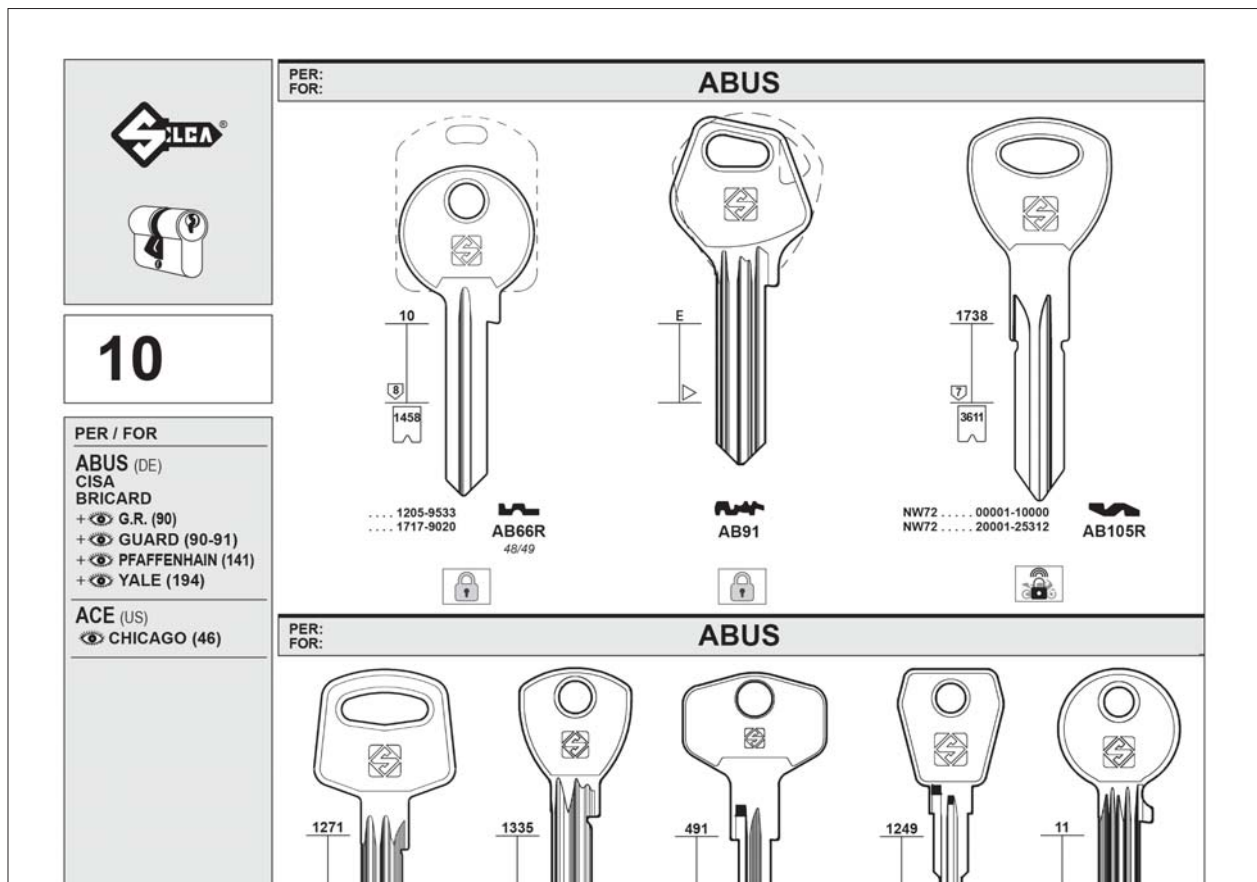

Keys are drawn to a 1:1 scale

EN - Identification of a key may be made by laying the sample on the drawing, paying particular attention to the blade and to the profile.
 Alternative head shapes are indicated by the dashed outlines around the standard head.

I disegni delle chiavi sono in scala 1:1

IT - I profili (sezione della canna) sono visti dalla testa.
 Per la ricerca basta sovrapporre la chiave campione al disegno esaminando particolarmente la canna (gambo) e la sezione (profilo).
 Teste originali diverse sono rappresentate con linea tratteggiata.

Die Zeichnungen der Schlüssel sind in Skala 1:1

DE - Die Profile (Schnitt der Stange) werden vom Kopf ab gesehen. Für die Suche genügt es den Musterschlüssel mit der angegebenen Zeichnung zu vergleichen, aber wir empfehlen, besonders die Stange und das Profil zu überprüfen.
 Verschiedene Originalköpfe sind durch gestrichelte Linien dargestellt.

Les dessins des clés sont à échelle 1:1

FR - Les profils (section du canon) sont vus de la tête.
 Pour la recherche il suffira de superposer la clé échantillon au dessin en examinant tout particulièrement le canon (tige) et la section (profil).
 Têtes originales différentes sont représentées par des lignes en tirets.

Los dibujos de las llaves son en escala 1:1

ES - Los perfiles (sección de la caña) son vistos de la cabeza. Para la búsqueda basta sobreponer la llave de muestra al dibujo, examinando con particular atención la caña y la sección (perfil).
 Las cabezas originales diferentes están representadas con una línea punteada.

Os desenhos das chaves estão em escala 1:1

PT - Os perfis (secção da cana) são vistos da cabeça.
 Para uma pesquisa eficiente, basta sobrepor a chave original por cima do desenho e examinar atentamente a cana da chave e o perfil.
 Cabeças originais diferentes estão representadas com uma linha tracejada.

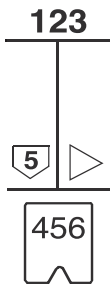

Technical Information

EN - Technical characteristics including the key head reference, number of pins and the cutting card code are indicated alongside each key. Standard materials and special finishes available for each reference are indicated in the Index on page 276.

Informazioni Tecniche

IT - Le caratteristiche tecniche, come la testa chiave, il numero di spine o la scheda di taglio, sono indicate a lato di ciascuna chiave. I materiali di produzione standard e le finiture in cui è possibile ordinare ciascuna referenza sono riassunti nell'Indice a pagina 276.

Technische Informationen

DE - Die technischen Merkmale, wie der Schlüsselkopf, die Anzahl der Plättchen oder die Schnittkarte, sind seitlich von jedem Schlüssel angegeben. Die Standardproduktionsmaterialien und Endbearbeitungen, die für jede Referenz bestellt werden können, sind zusammenfassend in dem Verzeichnis auf Seite 276 angegeben.

	TECHNICAL FEATURES	CARATTERISTICHE TECNICHE	TECHNISCHE MERKMALE
123	Head-shape code adjacent to each key for easy identification of customized coining dies	Codice testa per facilitare la scelta di conii personalizzati	Kopf-Code, um die Auswahl der Prägungen zu erleichtern
5	Number of big pins	Nr. spine grandi	Nr. grosse Dornen
5	Number of small pins	Nr. spine piccole	Nr. kleinen Dornen
▶	Back milled profile	Profilo dorsato	Rückengefrästes Profil
456	Card number for cutting by code on Silca electronic machines for flat keys	Numero scheda per riproduzione a codice con macchine elettroniche Silca per chiavi piatte	Kartennummer für die Kopierung nach Code auf Silca elektronische Schlüsselkopiermaschine für Flachschlüssel
S56	Silca serial number for cutting by code on Silca electronic machines for dimple and laser keys	Silca serial number per riproduzione a codice su duplicatrici elettroniche Silca per chiavi punzonate e laser	Silca Serial Number für die Kopierung nach Code auf Silca elektronische Schlüsselkopiermaschine für Bohrmulden- und Bahnschlüssel



Informations Techniques

FR - Les caractéristiques techniques, comme la tête de la clé, le nombre de goupilles ou la fiche de taillage sont indiquée à côté de chaque clé. Les matériaux de production standard et les finitions pour chaque article clé sont indiqués dans la Table des Matières page 276.

Información Técnica

ES - Las características técnicas, tales como cabeza llave, número de agujas o ficha de corte, se indican junto a cada llave. Los materiales de producción estándar y los acabados disponibles para cada referencia aparecen sintetizados en el índice de la página 276.



Informações Técnicas

PT - As características técnicas, como a cabeça da chave, o número de pivos ou a ficha de corte, estão indicadas ao lado de cada chave. Os materiais standard de produção e os acabamentos em que é possível encomendar cada referência estão resumidos no Índice da página 276.

123











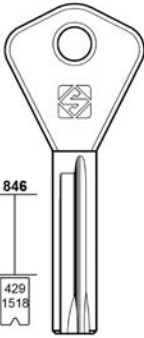

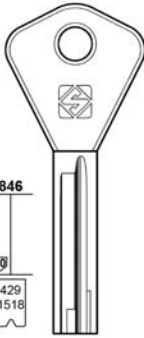

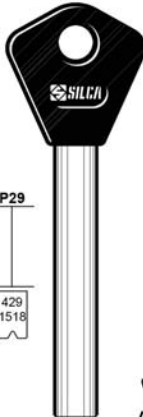





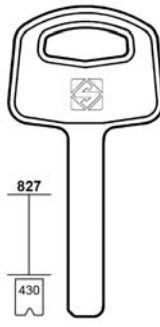



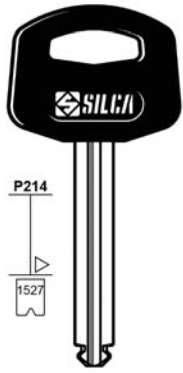





CARACTÉRISTIQUES TECHNIQUES	CARACTERÍSTICAS TÉCNICAS	CARACTERÍSTICAS TÉCNICAS	
Code de la tête pour faciliter le choix des frappes personnalisées	Código de la cabeza para facilitar la elección de acuñaciones personalizados	Código da cabeça para facilitar a escolha dos cunhos personalizados	123
Nr. grands pistons	Nr. de agujas grandes	Nr. de pivos grandes	5
Nr. petits pistons	Nr. de agujas pequeñas	Nr. de pivos pequeños	5
Profil à chiffrage dorsal	Perfil lomeado	Perfil boleado no dorso	
Numéro de fiche pour la reproduction à code sur machines électroniques Silca pour clés plates	Número de la ficha para la reproducción a código con duplicadoras electrónicas Silca para llaves planas	Número de ficha técnica para a duplicação pelo código nas máquinas electrónicas Silca (chaves planas)	456
Silca serial number pour la reproduction à code sur machines électroniques Silca pour clés a points et laser	Silca serial number para la reproducción a código con duplicadoras electrónicas silca para llaves de seguridad y de regata	Silca serial number para a duplicação pelo código nas máquinas eletrónicas Silca para chaves de pontos e laser	S56

6

PER / FOR
ABLOY (FI)
ABT (IT)
 VIRO (206)
ABUS (DE)
 CISA
 JPM
 OTHMER
 TOP
 + CISA (55-56-57)
 + G.R. (90)
 + GUARD (90-91)
 + PFAFFENHAIN (141)
 + YALE (194)

PER: FOR:	ABLOY							
 846  429 1518	 846  429 1518	 P29  429 1518	 AY28 RAB DX (DX) (SX) 0-1-2-3-4-5-6-7-8-9	 AY29 RAG (DX) (SX) 0-1-2-3-4-5-6-7-8-9	 AY10P			
								
PER: FOR:	ABUS							
 827  430	 P214  584 716 1519	 P214  1527	 AB32 1-2-3-4-5-6 GRANIT	 AB38P 1-2-3-4-5-6 ABUS PLUS	 AB60P 1-2-3-4-5-6			
								
PER: FOR:	ABUS							
	 A31R 1-2-3-4-5-6	 AB10R F3 BCISS 1-6032 F3D 1,6032	 AB8	 AB8R	 A136	 AB36R	 JM1 CS	 JM1R CS

EN - The main uses of each key are indicated by an intuitive icon below the profile of the key

FR - Les utilisations principales de chaque clé sont illustrées par des icônes faciles à interpréter sous le profil de la clé

IT - Gli utilizzi principali di ciascuna chiave sono indicati tramite icone di facile lettura sotto il profilo della chiave stessa

ES - Los usos principales de cada llave se indican con iconos de fácil lectura bajo el perfil de dicha llave

DE - Die Hauptverwendungen für jeden Schlüssel sind mit leicht verständlichen Symbolen unter dem Profil des Schlüssels angegeben

PT - As utilizações principais de cada chave estão indicadas por meio de ícones fáceis de ler por baixo do perfil da própria chave

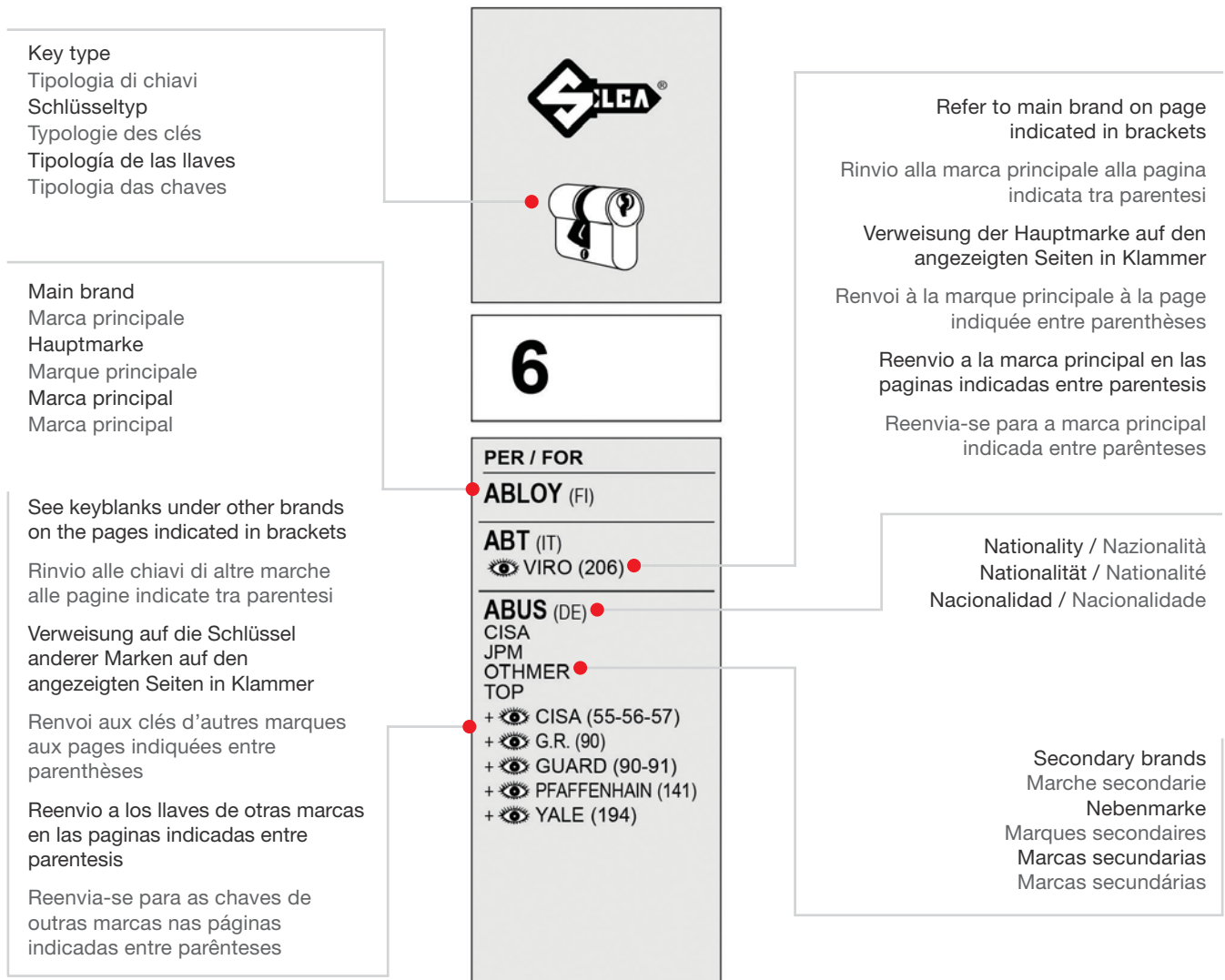

















Nationality / Nazionalità / Nationalität / Nationalité / Nacionalidad / Nacionalidade

AR	Argentina	DZ	Algeria	IE	Ireland	RO	Romania
AT	Austria	DE	Germany	IL	Israel	RS	Serbia
AU	Australia	DK	Denmark	IN	India	RU	Russia
AZ	Azerbaijan	DZ	Algeria	IT	Italy	SA	Saudi Arabia
BE	Belgium	EE	Estonia	JP	Japan	SE	Sweden
BG	Bulgaria	EG	Egypt	LT	Lithuania	SI	Slovenia
BR	Brazil	ES	Spain	LV	Latvia	TN	Tunisia
BY	Belarus	FI	Finland	MD	Republic of Moldova	TR	Turkey
CA	Canada	FR	France	ME	Montenegro	TW	Taiwan
CH	Switzerland	GB	Great Britain	NG	Federal Rep.of Nigeria	UA	Ukraine
CL	Chile	GR	Greece	NL	The Netherlands	US	United States of America
CN	China	HK	Hong-Kong	NO	Norway	VE	Venezuela
CO	Colombia	HR	Croatia	PL	Poland	ZA	Republic of South Africa
CZ	Czech. Repub.	HU	Hungary	PT	Portugal	ZM	Zambia

EN - The wide range of Silca articles allows you to copy keys for various uses, such as padlocks, furniture locks, safes, electric boards, shutter locks and many more. At the end of the catalogue there are specific sections dedicated to dimple, cruciform and mail box keys.

IT - La gamma di articoli Silca consente di duplicare chiavi per i più disparati utilizzi come lucchetti, cilindri per mobili, cassette di sicurezza, quadri elettrici, serrature per serranda e molti altri. Alla fine del catalogo sono presenti inoltre delle sezioni specifiche dedicate alle chiavi punzonate, alle chiavi a croce e alle chiavi per casellari postali.









DE - Das Sortiment der Silca-Artikel ermöglicht das Fräsen von Schlüsseln für die unterschiedlichsten Verwendungen wie Schlösser, Zylinder für Möbel, Safes, Schaltschränke, Rollläden und viele andere mehr. Am Ende des Katalogs befinden sich spezifische Abschnitte für Bohrmulden-, Kreuzbart-, und Fachkastenschlösser.

	USES	UTILIZZI	VERWENDUNGEN
	Padlocks	Lucchetti	Vorhangschlösser
	Security cylinders	Cilindri di sicurezza	Sicherheitszylinder
	Electric boards	Quadri elettrici	Schalttafel
	Mail boxes	Casellari postali / Cassette per lettere	Fachkasten
	Cash register locks	Registratori di cassa	Registriermaschine
	Furniture locks	Cilindri per mobili	Möbelzylinder
	Steering column locks	Bloccasterzo	Lenkschlösser
	Shutter locks	Serrature per serranda	Fallturschlösser
	Phone locks	Blocca telefono	Telefonschlösser
	Glass door locks	Blocca cristalli	Glasschiebetürschlösser
	Locomotives	Locomotive	Lokomotive
	Briefcases	Valigette	Köfferchen
	Safes	Cassette di sicurezza	Sicherheitsfach
	Lifts	Ascensori	Aufzüge
	Juke box / Flipper	Juke box / Flipper	Juke box / Spielautomaten
	Bicycle	Biciclette	Fahrrad
	Antitheft devices for motorcycles	Antifurto per ciclomotori / motociclette	Diebstahlschutz für Motorrad und Motorräder

FR - La gamme d'articles Silca permet de reproduire des clés pour les usages les plus disparates comme les chaînes, les cylindres pour meubles, les coffres, les tableaux électriques, les serrures de rideaux métalliques et bien d'autres encore. À la fin du catalogue vous trouverez aussi des chapitres dédiés aux clés à points, cruciformes et pour boîtes postales.

ES - La gama de artículos Silca permite duplicar las llaves para los usos más dispares, tales como candados, cilindros para muebles, cajas de seguridad, cuadros eléctricos, cerraduras para cierres y otros muchos. El catálogo contiene al final también secciones específicas dedicadas a las llaves de seguridad, en cruz y para casilleros postales.

PT - A gama de artigos Silca permite duplicar chaves para as utilizações mais diferentes, como cadeados, cilindros para móveis, caixas de segurança, quadros eléctricos, fechaduras para grades e outras ainda. No fim do catálogo também se encontram secções específicas dedicadas às chaves de pontos, tetra e para caixas de correio.

UTILISATIONS	UTILIZACIONES	UTILIZAÇÕES	
Cadenas	Candados	Cadeados	
Cylindres de sécurité	Cilindros de seguridad	Cilindros de segurança	
Tableaux électriques	Cajas eléctricas	Quadros eléctricos	
Boîtes postales / Boîtes aux lettres	Casillas postales / Buzones	Caixas de correio	
Caisse enregistreuse	Registradoras de caja	Caixas registradoras	
Cylindres pour meubles	Cilindros para muebles	Cilindros para mobiliário	
Blocage volant	Bloqueo para direcció	Bloqueios da direcção	
Serrures pour stores métalliques	Cerraduras para cortinas metálicas	Fechaduras para grades de enrola	
Blocage du téléphone	Bloqueo para teléfonos	Bloqueios de telefone	
Blocage porte en verre	Bloqueos para cristales	Trava dos vidros	
Locomotive	Locomotora	Locomotivas	
Mallettes	Maletines	Maletas	
Coffres-forts	Caja de seguridad	Cofres	
Ascenseurs	Ascensores	Elevadores	
Juke box / Flipper	Juke box / Flipper	Juke box / Flipper	
Vélo	Bicicleta	Bicicleta	
Antivols pour cyclomoteurs / motocyclettes	Antihurto para ciclomotores y motocicletas	Anti-roubo para scooters e motocicletas	

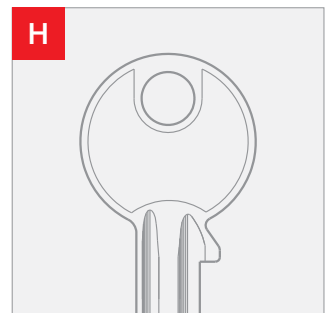
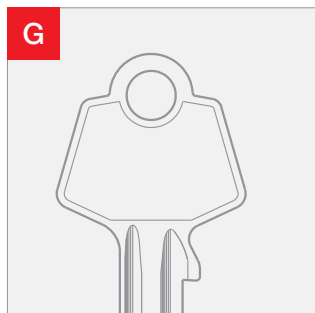
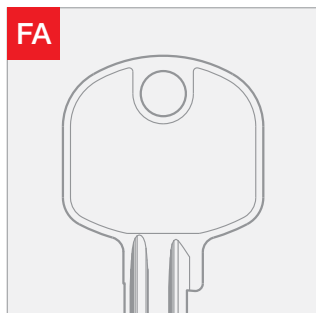
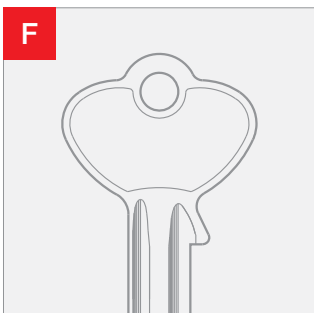
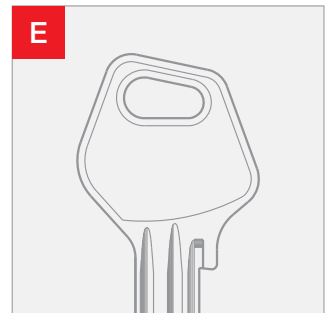
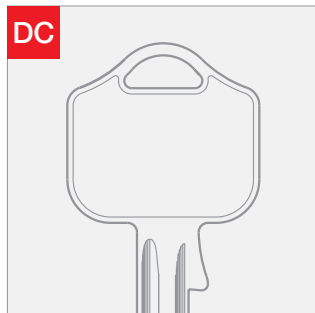
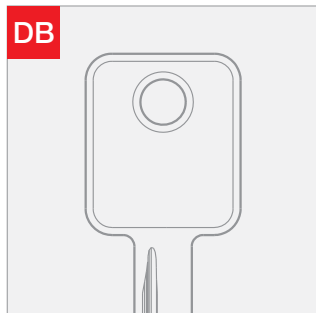
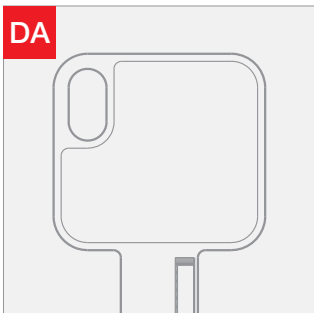
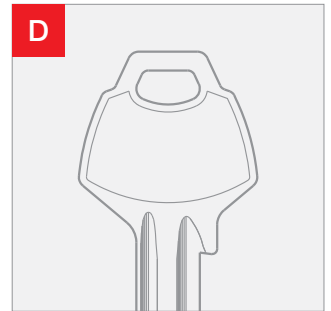
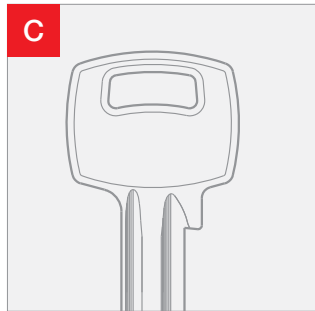
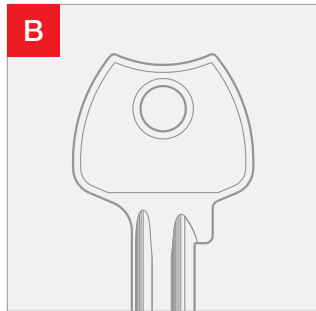
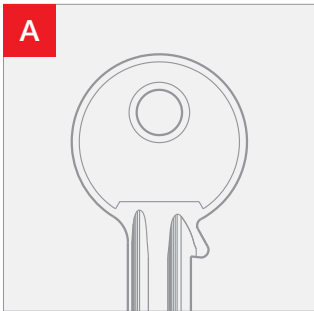

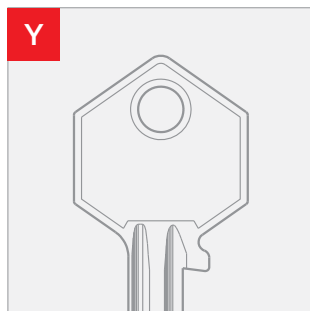
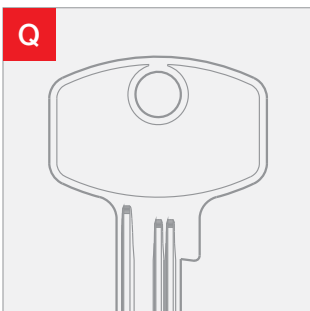
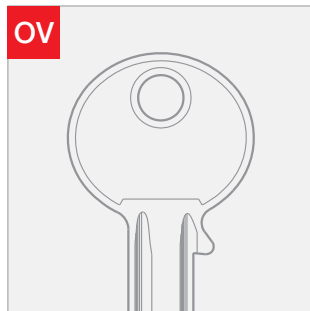
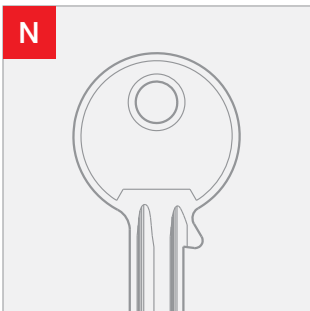
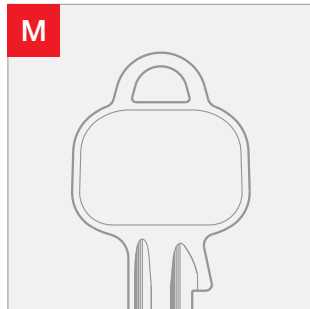
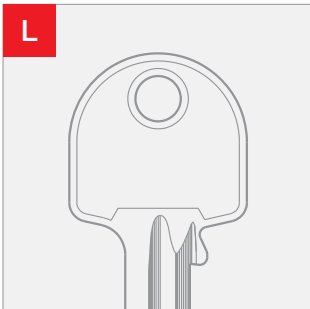

EN - With the Silca 'Serie Distinzione' you will be able to customize your keys with your logo and the contact details of your shop, choosing from 18 different heads and a wide range of keys.

IT - Con la 'Serie Distinzione' Silca potrai personalizzare le tue chiavi con il logo e i recapiti del tuo negozio, scegliendo fra 18 teste diverse e un'ampia gamma di referenze.

DE - Mit der 'Serie Distinzione' können Sie Ihre Schlüssel mit dem Logo und den Daten Ihres Geschäftes personalisieren. Zur Auswahl stehen 18 verschiedene Köpfe und eine breite Referenzpalette.

FR - La 'Serie Distinzione' Silca vous permettra de personnaliser vos clés avec le logo et l'adresse de votre magasin dans les 18 têtes différentes d'une vaste gamme d'articles.

ES - Con la 'Serie Distinzione' Silca, podrás personalizar tus llaves con el logo y los datos de tu tienda; elige entre 18 cabezas distintas y una gama amplia de referencias.

PT - Com a 'Serie Distinzione' Silca, poderá personalizar as suas chaves com o logotipo e os recados da sua loja, escolhendo entre 18 cabeças diferentes e uma ampla gama de referências.

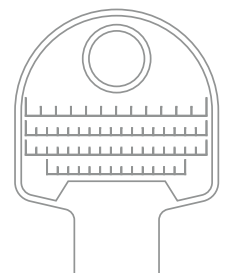

A								
	AA1	CS15R	FH13	JW7R	MN7	PF18	TO26	WA1R
	AA1R	CS204	FH15	JW8	MN7R	PF210	TP1	WA2
	AA5	CS205	FH18	JW9	MON1	PF211	TP1R	WA2R
	AA5R	CS206	FH8R	JW9R	MON1R	PF2S	TP2	WA6
	AA6	CS207	FI6	KAK1	MP228	PF7	TP2R	WA6R
	AA6R	CS33	FM090	KEI1R	MP229	PF7S	TR2	WE1
	AAA1	CS33R	FM2	KK1	MP230	PF8	TRM2	WE13
	AB14	CS38	GD2	KLE3R	MP231	PF8R	TRM3	WE13R
	AB14R	CS68	GO1R	KLE3RX	MSF1	PG1	TS1	WE14
	AB54	CS7	GO2R	KLE3X	MTA1R	PG1R	TS2	WE14R
	AG2	CS70	GS7	KLE5RX	MTA3R	PT2	TU1	WE15
	AG2R	CT1	GSS1	KLE5X	MTA4	RIQ9	UAP2	WE15R
	AG3	CT1R	HDL3	KLE6RX	MTK5	RIQ9R	UL046	WE16
	AG3R	CT2	HDL3R	KLE6X	MTK5R	RM1A	UL047	WE16R
	AG4	CT2R	HE1	KLE7RX	NF1	RM1RA	UL048	WE1R
	AG4R	CVL1	HE1R	KLE7X	NF1R	RM2A	UL049	WE2
	AG7	CVL1R	HE3	KM1	OA2	RM2RA	UL050	WE2R
	AG7R	CVL3	HE3R	KM1R	OA2R	RZA3	UL051	WE5
	AGB1R	CVL3R	IB1	LD4	OA3	SCM4	UL052	WE5R
	AKR9R	CVL4	ICS1	LD4R	OA3R	SE7	UL053	WE6
	ALM1	DEA2	ICS1R	LD5R	OL1	SE7R	UL054	WE6R
	ALM1R	DM32	ICS2	LN1	OL1R	SIL1	UL055	WE7
	AMC1R	DO1R	ICS2R	LP13	OL2	SIL1R	UL058	WE7R
	AMC2R	EA1	ICS3	LP13R	OL2R	SN3R	UL059	WMS1
	AMC3	ECM1	ICS3R	LP20R	OL3	SN4R	UL062	WMS2
	AZ2	ECM1R	IE6	LP5	OL3R	SO4	UL063	WR1
	AZ2R	EL1	IE8	LP5R	OL4	SO7	UL064	WR2
	AZ2X	EN2R	IE8R	LP7	OL4R	SO8R	UM2	YA1
	AZ4	ER2	IL1	LP7R	OL5	SQ4R	UNI3	YA226
	BAI5R	ER3R	IL1R	LT2	OL5R	SS12	VAC29	YA31
	BAL7	EVO1	ILS1	MG1	OL6	STA1	VI080	YA31R
	BD2	F2R	JOW8	MG1R	OL6R	STA1R	VI081	YA6
	BD2R	FAM1	JS1	MG2	OV1	STA2	VI082	YAR1
	BE200	FAM1R	JS1R	MG2R	OV1R	STA2R	VI083	YT15
	BE202	FAM2	JW1	MG3	OV2	STA3	VI086	ZA2R
	BI110	FAM2R	JW10	MG3R	OV2R	STA3R	VI1	ZI1
	BM1	FB108	JW10R	MI1	PC1	SVN2	VI10	ZI1R
	BM2	FB26	JW11	MI1R	PC10	TAR11	VI10R	ZI2
	BR1	FB26R	JW12	MI2	PC10R	TAR11R	VI11	ZI2R
	BS1	FEB1	JW13	MI2R	PC14	TAR4	VI12	ZI4
	CA10	FEB1R	JW13R	MI5	PC18R	TAR4R	VI13	ZI4R
	CA10R	FEB2	JW1R	MI5R	PC1R	TAR5	VI1R	ZI5
	CB20	FEB2R	JW2	MIG1	PC20	TAR5R	VI2	ZI5R
	CB5	FF1	JW2R	MIG1R	PC26	TAR9	VI23	
	CB6	FF1R	JW3	MIG2	PC27	TAR9R	VI2R	
	CB78R	FF2	JW3R	MIG2R	PC31R	TG1	VI6	
	CB83	FF7	JW4	MN1	PC32R	TL11	VI9	
	CC1	FF7R	JW4R	MN2	PC33	TL11R	VI9R	
	CEE1	FF8	JW5	MN2R	PC33R	TL13	VL2	
	CLS242	FF8R	JW5R	MN3	PC4	TN16	VL2R	
	CLS3	FF9	JW6	MN3R	PC4R	TN16X	VL3	
	COR1	FF9R	JW6R	MN4	PF092	TN2	VL3R	
	CS121	FH10R	JW7	MN4R	PF092S	TN39	WA1	

B 	CS204	IE2R	UL051
	CS205	LW1	UL052
	CS206	LW1R	UL053
	CS207	MG1R	WA1
	EL1	UL050	WA1R

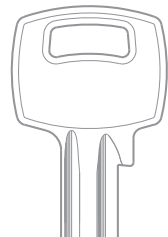
C 	ADT1	IB1	VI082
	CS204	UL050	VRF3
	CS205	UL051	VRF4
	CS206	UL052	WA1R
	CS207	UL053	WA2R
	EL1	VI080	

D 	CS204	EL1	UL050
	CS205	JL2	UL051
	CS206	JL2R	UL052
	CS207	PC9	UL053

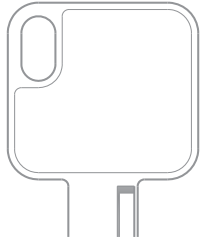
DA 	AB1	CS207	TO30R
	BK1	DM119	UL050
	CS206	MTA3R	

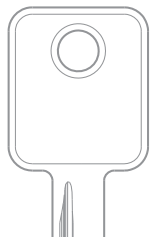
DB 	AB3	BUR2	DM8
	AB3R	BUR2R	HN1
	BA2	CE4	HW1
	BA2R	CE7	JU1
	BUR1	CS7	JU1
	BUR1R	DM10	YA8

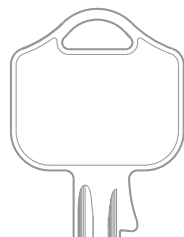
DC 	LW4	UL050	UL051
---	-----	-------	-------

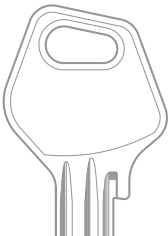
E 	AB91	FM1	JL5	VL2R
	BK26	FM6	PC13	VL5
	CB6	FM7	PC27	VL5R
	CS204	IB1	PC28	WST1
	CS205	JL3	UL050	WTR1R
	CS206	JL3R	UL051	
	CS207	JL4	UL052	
	EL1	JL4R	UL053	

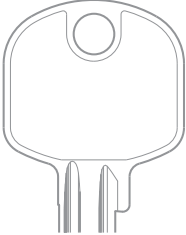

F 	CS204	EL1	UL051
	CS205	UL050	UL052
	CS206		

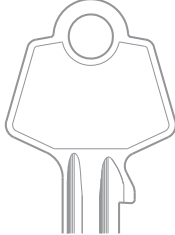
FA			
	AB1	CS24	TN19R
	AB1RX	DM14	TN23
	AB1X	EV10	TO1
	BAI1	GR3	TOP1R
	BD3	IB1	TOP1RX
	BD3R	IE6	UL050
	BD9R	IE6R	UL050X
	BK1	JM1	UL051
	CA2	JM2R	VAC151
	CB6	LH42	VAC2
	CE2	LT2	VAC48
	CE2X	RO41	WK1
	CS13	RO8	YA1
	CS206	TE2	YA226
	CS207	TE8X	

G		
	CB6	PF2
	CS204	UL050
	CS205	UL051
	CS206	UL052
	CS207	UL053
	EL1	

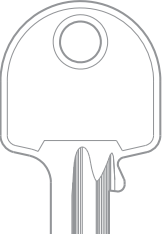
H		
	CS206	MN8
	CS207	MN8R
	DS5R	MN9
	FF10	MN9R
	FF10R	UL050
	FF2	UL052
	FF3	WA7
	FF3R	WA7R

L							
	AB1R	CE2	EV69X	HUT1	PF092S	UL053	YA31
	AB1X	CE20	EZ2R	IB1	PF2	UL054	YA6
	AB36	CE2X	FAC7	IE12	PF212	UL054SL	YT15
	AB36R	CE41	FB13R	IE2	PF2S	UL055	YT16
	AB54	CS13X	FB13RX	IE6	STL1R	UL058SL	ZE12X
	AB63	CS143	FB15R	JOW10	TE2	UL062	ZE1RX
	AE2R	CS204	FB15RX	JS2	TE2X	UL063	ZE1X
	AG3	CS205	FB19R	KF1	TE6	UL064	
	AG3R	CS206	FB19RX	LC11	TN16X	UNI3	
	AGA6	CS207	FB20R	LC11R	TN2	VAC2	
	AGB1R	CS68	FB20RX	LC2	TO1X	VI080	
	AGB2R	CV1	FB21R	LC2R	TO30R	VI081	
	ASEC1	CV3	FB21RX	LP21	TO30RX	VI082	
	ASEC2	CVL1R	FB22R	LP5	TOP1R	VL2R	
	AZ2	CVL3R	FB22RX	LT2	TOP1RX	WA1	
	AZ2R	CYS1	FB25R	LT4	UC1R	WA1R	
	AZ2X	DM119	FB25RX	LW4	UL050	WA2R	
	BAB13	DM14	FB28R	LW5	UL050SL	WE2R	
	BK1X	DM151R	FB28RX	MC12	UL050X	WE11	
	BK5-16	DM3X	FDR2	MC2	UL051	WK1X	
	BK5-6	EL1	FF2	MC2R	UL051SL	WMS1	
	BRM1	EV10	FH31L	MER8	UL051X	YA1	
	CB6	EV10X	GE1	MXU2	UL052	YA1E	
	CB6X	EV4	GE106	PF092	UL052SL	YA226	

<div style="background-color: red; color: white; padding: 2px; text-align: center; font-weight: bold;">M</div> 	AE1R BNL1R CS204 CS206 IB1 KS1 MIL2 UL050	UL051 UL052 UL053 VI080 VI082 WA1R YA1E YA226	<div style="background-color: red; color: white; padding: 2px; text-align: center; font-weight: bold;">N</div> 	BD17 BSI1 BSI1R BSI2 BSI2R BSI4 BSI4R CA1 CA9 CB15 CB3 CB85 CC1 CC1R CEN2 CEN2R CS7 CS7R FF14 FF17 FF18	GL3 GL3R GL4 GL4R IE1 IE1R IE28R IE3 IE3R JB1 JL1 JOW4R JU1 JU1R MN5 MN5R MTY1 MTY2 NE34 OB1 OC074	PA2 PA2R PF070 PF9 RGM1 RGM1R RR10R RR2 RR2R RR3 RR4 RR6 RR8R RX1 STA8 STA8R TAR3 TAR3R TAR8 TAR8R TRE2	UL056 UL057 UL058 UL059 UL060 UL061 VI084 VI085 VI086 VI087 WE3 WE3R WK3 YD4 YD4R YT13 YT13R YT7 YT7R ZI3 ZI3R

<div style="background-color: red; color: white; padding: 2px; text-align: center; font-weight: bold;">OV</div> 	AB10 AB101RX AB10RX AB1RX AB1X AB4 AB5 AB55X AB6 AB68X AB69X AB70X AB79RX AB8 AB88X AL1 AL1R ARE1 ASS186 AZ5 BAB31 BAI23 BAL1 BAL1R	BG1 BK1 BK13 BK1R BK1X BK21R BK22R BK23R BK27 BK2R BK3-1 BK3-10 BK3-11 BK3-12 BK3-2 BK3-3 BK3-4 BK3-5 BK3-6 BK3-7 BK3-8 BK3-9 BK48R BK49R	BK5-1 BK5-10 BK5-11 BK5-12 BK5-13 BK5-14 BK5-15 BK5-16 BK5-17 BK5-18 BK5-19 BK5-2 BK5-20 BK5-21 BK5-22 BK5-23 BK5-24 BK5-25 BK5-26 BK5-27 BK5-28 BK5-29 BK5-3 BK5-30	BK5-31 BK5-32 BK5-33 BK5-34 BK5-35 BK5-4 BK5-5 BK5-6 BK5-7 BK5-8 BK5-9 BK6-1 BK6-10 BK6-11 BK6-12 BK6-13 BK6-14 BK6-15 BK6-16 BK6-17 BK6-18 BK6-19 BK6-2 BK6-20	BK6-21 BK6-22 BK6-23 BK6-24 BK6-25 BK6-26 BK6-27 BK6-28 BK6-29 BK6-3 BK6-30 BK6-31 BK6-32 BK6-33 BK6-34 BK6-35 BK6-4 BK6-5 BK6-6 BK6-7 BK6-8 BK6-9 BK7R-1 BK7R-10	BK7R-2 BK7R-3 BK7R-4 BK7R-5 BK7R-6 BK7R-7 BK7R-8 BK7R-9 BLA1 BLA2 BLA3 BRT1 BRT2 BRT3 BRT4 BVA1 BVA1R BY1 C1 C1R CB104R CB106 CB6 CB6X	CE1 CE17WPS CE1R CE2 CE20 CE2R CE2X CE41 CE5 CO1 CO1R CS13X CS163X CS206 CS207 CS52X DF3 DF3R DM105R DM11 DM119 DM123-1 DM123-10 DM123-2	DM123-3 DM123-4 DM123-5 DM123-6 DM123-7 DM123-8 DM123-9 DM25 DM28 DM3 DM35R DM3X DM48 DM7 DO6 EM11 ER1 ERT1 ET1 ET1R ET2 ET2R EV10X EV3

OV





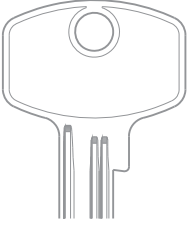





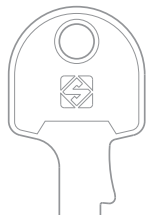

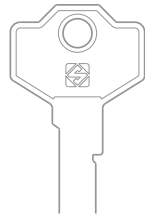
EV69X	KF1	ORA2	TO30R	TO8X13	UL050	WK27	YA9
FAM6	KFA	RG1	TO30RX	TO8X14	UL050X	WK28	YYA
FB35R	KFB	RO8	TO30X	TO8X15	UL051	WK29	YYA6
FH16R	KFC	RU1	TO31R	TO8X16	UL051X	WK2R	YYB
FH30	KFD	RU10R	TO34	TO8X17	UNI28	WK30	YYB6
FS1	KFE	RU11R	TO39R	TO8X18	UP1	WK31	YYC
FS1R	KFF	RU12	TO4	TO8X2	VAC151	WK32	YYC6
FV1	KFG	RU13	TO5	TO8X3	VAC30	WK33	YYD
GD8	KFH	RU16	TO54-1	TO8X4	VAC30R	WK34	YYD6
GD8R	KFI	RU19	TO54-13	TO8X5	VG1	WK35	YYE
GE1	KFJ	RU1R	TO54-14	TO8X6	VYA	WK36	YYE6
GOD4R	KFK	RU2	TO54-16	TO8X7	VYA6	WK37	YYF
GR1R	KFL	RU20	TO54-17	TO8X8	VYB	WK38	YYF6
GR9-5	KFM	RU21	TO54-18	TO8X9	VYB6	WK39	YYG
GR9-7	KFN	RU22R	TO54-19	TO9RY1	VYC	WK4	YYG6
GR9-8	KFO	RU23R	TO54-2	TO9RY10	VYC6	WK40	YYH
GR9-9	KFR	RU28	TO54-20	TO9RY11	VYD	WK41R	YYH6
GR9R-1	KFS	RU29R	TO54-21	TO9RY12	VYD6	WK42R	YYK
GR9R-2	KFU	RU2R	TO54-23	TO9RY13	VYE	WK43R	YYK6
GR9R-3	KFW	RU3	TO54-24	TO9RY14	VYE6	WK44R	YYP5A
GR9R-4	KFX	RU30	TO54-3	TO9RY15	VYF	WK45R	YYP5B
GR9R-5	LH4	RU3R	TO54-4	TO9RY16	VYF6	WK45X	YYP5D
GR9R-6	LH42	RU4	TO54-5	TO9RY17	VYG	WK46	YYP6A
GV7	LP21	RU4R	TO54-6	TO9RY18	VYG6	WK47R	YYP6B
GYA	LP5	RU5	TO54-7	TO9RY2	VYH	WK48	YYP6D
GYA6	LW24	RU5R	TO54-8	TO9RY3	VYH6	WK5	ZE1
GYB	LYA	RU6	TO6	TO9RY4	VYK	WK52R	ZE10
GYB6	LYA6	RU7	TO7	TO9RY5	VYK6	WK53R	ZE10R
GYC	LYB	RU8R	TO75R	TO9RY6	VYP5A	WK54R	ZE12
GYC6	LYB6	RU9R	TO81R	TO9RY7	VYP5B	WK56R	ZE12X
GXD	LYC	SAN1	TO82R	TO9RY8	VYP5D	WK57	ZE13
GXD6	LYC6	SAN1R	TO8RX1	TO9RY9	VYP6A	WK6	ZE13R
GYE6	LYD	SEI10	TO8RX10	TO9Y1	VYP6B	WK62R	ZE15
GYF	LYD6	SHW1	TO8RX11	TO9Y10	VYP6D	WK6R	ZE16
GYF6	LYE	ST1	TO8RX12	TO9Y11	WK1	WK7	ZE1R
GYG	LYE6	STL1RX	TO8RX13	TO9Y12	WK10	WK71X	ZE1RX
GYG6	LYF	STU1	TO8RX14	TO9Y13	WK11	WK87X	ZE1X
GYH	LYF6	SV3	TO8RX15	TO9Y14	WK12	WK9	ZE2
GYH6	LYG	SV3R	TO8RX16	TO9Y15	WK13	WSD1	ZE34
GYK	LYG6	SV7	TO8RX17	TO9Y16	WK14	WSD1R	ZE34R
GYK6	LYH	TN16X	TO8RX18	TO9Y17	WK15	YA1	ZE34RX
GYP5A	LYH6	TO1	TO8RX2	TO9Y18	WK16	YA27R	ZE34X
GYP5B	LYK	TO108X	TO8RX3	TO9Y2	WK17R	YA31	ZE39
GYP5D	LYK6	TO15	TO8RX4	TO9Y3	WK18	YA5	ZE39R
GYP6A	LYP5A	TO16	TO8RX5	TO9Y4	WK19	YA67	ZE39RX
GYP6B	LYP5B	TO17	TO8RX6	TO9Y5	WK1X	YA70	ZE39X
GYP6D	LYP5D	TO1X	TO8RX7	TO9Y6	WK2	YA70R	ZE40X
HT2	LYP6A	TO2	TO8RX8	TO9Y7	WK20	YA71	
IE6X	LYP6B	TO25R	TO8RX9	TO9Y8	WK21	YA71R	
JOW1	LYP6D	TO28R	TO8X1	TO9Y9	WK22	YA72	
JOW12RX	MEG2	TO29X	TO8X10	TOP1RX	WK25	YA72R	
JOW12X	MIL1	TO3	TO8X11	TR15	WK25R	YA84	
JOW1R	NME3	TO30	TO8X12	TU2	WK26	YA84R	





Q								
	AB1	DM12-24	DM12-9	DM42	DM65-21	DM65R-00	DM76	DM91
	AB1R	DM12-25	DM12R-00	DM42R	DM65-22	DM65R-12	DM76R	DM91R
	BK1	DM12-26	DM12R-12	DM43	DM65-23	DM65R-13	DM77	DM92
	CE2	DM12-27	DM12R-13	DM43R	DM65-24	DM65R-16	DM77R	DM92R
	CS206	DM12-28	DM12R-16	DM44	DM65-25	DM65R-19	DM78	DM93
	DM103	DM12-29	DM12R-19	DM44R	DM65-26	DM65R-31	DM78R	DM93R
	DM108	DM12-3	DM12R-31	DM45	DM65-27	DM65R-32	DM79	DM94
	DM108R	DM12-30	DM12R-32	DM45R	DM65-28	DM65R-34	DM79R	DM94R
	DM109	DM12-31	DM12R-34	DM46	DM65-29	DM65R-35	DM80	DM95
	DM109R	DM12-32	DM12R-35	DM46R	DM65-3	DM65R-36	DM80R	DM95R
	DM115	DM12-33	DM12R-36	DM47	DM65-30	DM66	DM81	DM97R
	DM115R	DM12-34	DM132	DM47R	DM65-31	DM66R	DM81R	LEA1
	DM119	DM12-35	DM132R	DM50	DM65-32	DM67	DM82	TE2
	DM12-00	DM12-36	DM14	DM50R	DM65-33	DM67R	DM82R	TO1
	DM12-1	DM12-37	DM141R	DM60	DM65-34	DM68	DM83	TOP1R
	DM12-10	DM12-38	DM150	DM60R	DM65-35	DM68R	DM83R	UL050
	DM12-11	DM12-39	DM151R	DM65-00	DM65-36	DM69	DM84	UL051
	DM12-12	DM12-4	DM152	DM65-1	DM65-4	DM69R	DM84R	VAC2
	DM12-13	DM12-40	DM154	DM65-10	DM65-40	DM70	DM85	VI15R
	DM12-14	DM12-41	DM154R	DM65-11	DM65-41	DM70R	DM85R	VI16R
	DM12-15	DM12-42	DM18	DM65-12	DM65-42	DM71	DM86	WK1
	DM12-16	DM12-43	DM18R	DM65-13	DM65-43	DM71R	DM86R	YA1
	DM12-17	DM12-44	DM20	DM65-14	DM65-44	DM72	DM87	ZE1
	DM12-18	DM12-45	DM26	DM65-15	DM65-45	DM72R	DM87R	ZE1R
	DM12-19	DM12-46	DM26R	DM65-16	DM65-46	DM73	DM88	
	DM12-2	DM12-47	DM29	DM65-17	DM65-5	DM73R	DM88R	
	DM12-20	DM12-5	DM29R	DM65-18	DM65-6	DM74	DM89	
	DM12-21	DM12-6	DM33R	DM65-19	DM65-7	DM74R	DM89R	
	DM12-22	DM12-7	DM40	DM65-2	DM65-8	DM75	DM90	
	DM12-23	DM12-8	DM40R	DM65-20	DM65-9	DM75R	DM90R	

Y								
	EL1	UL051	YA31	YA44	YA49	YA54	YA59	YA63
	JH1	UL054	YA31R	YA45	YA50	YA55	YA6	YA6R
	PC11	VAL1	YA41	YA46	YA51	YA56	YA60	
	PC11R	YA226	YA42	YA47	YA52	YA57	YA61	
	UL050	YA227	YA43	YA48	YA53	YA58	YA62	



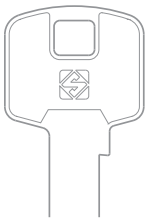
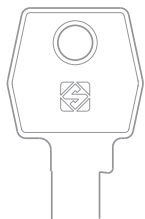
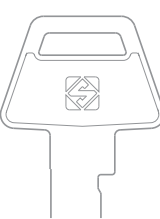

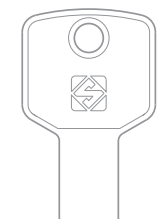
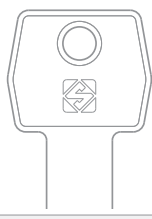
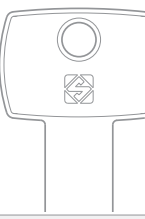
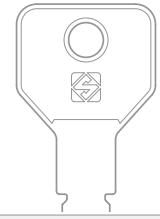
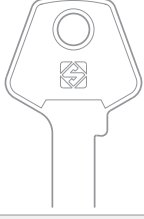
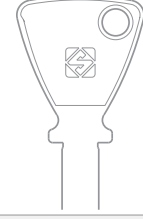





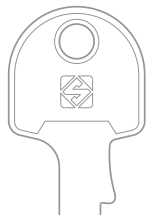

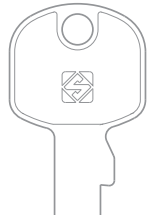
<p>A</p> 	<p>L</p> 	<p>N</p> 	<p>22</p> 	<p>29</p> 	<p>31</p> 
<p>CB6 CB7 CB8 CB9 CB10 CB11 CB12 CB13 CB14 CB15 CB16 CB17 CS204 CS206 FM090 FM1 IE6 JM2R MTA1R UL050 UL051 VI080 VI082 WA1R WA2R</p>	<p>UL050 UL050SL UL051SL UL052SL UL053SL UL054SL UL055SL UL058SL YT15L YT16L</p>	<p>CB85 CC1 CS7 IE3 UL058 VI084 VI086</p>	<p>SM1</p>	<p>OC074</p>	<p>PF2 PF092 PF092S</p>
	<p>OV</p> 	<p>Y</p> 	<p>168</p> 	<p>182</p> 	<p>369</p> 
	<p>RU1 VAC151</p>	<p>YA226 YA31 YA6</p>	<p>UNI3</p>	<p>YA1</p>	<p>TE2</p>

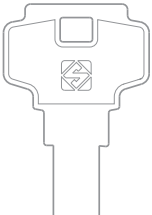

<p>423</p>  <p>MER8</p>	<p>599</p>  <p>AGB1R</p>	<p>754</p>  <p>RU14</p>	<p>1130</p>  <p>IE15</p>	<p>1182</p>  <p>BD9R</p>	<p>1219</p>  <p>CS62 CS115</p>
<p>1275</p>  <p>AGB5 AGB8</p>	<p>1434</p>  <p>CB97</p>	<p>1456</p>  <p>CS146</p>	<p>1557</p>  <p>MER1</p>	<p>1604</p>  <p>KE1</p>	<p>1605</p>  <p>KE3</p>
<p>1606</p>  <p>KE9</p>					

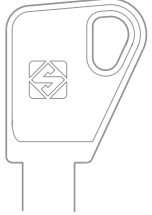

<p>OV</p> 	<p>L</p> 	<p>A</p> 	<p>FA</p> 	<p>1</p> 	<p>16</p> 
<p>AB1X BK1X BK3-3 BK3-4 BK3-7 BK3-8 BK3-12 CB6 CE1 CE2 CE2X DM3 DM3X KF1 LP5 TO1X UL050X WK1X ZE1 ZE1RX ZE1X ZE2</p>	<p>AB1X BE201 BK1X CB6 CE2X DM3X EV69X TO1X TO30RX UL050X UL052 WK1X</p>	<p>AG2R AG3 BE200 BE202 TN2 UL054 VAC29 VI080</p>	<p>BK1</p>	<p>BE200</p>	<p>DX1</p>
		<p>54</p> 	<p>EV3R EV3X EV10X1 EV69X GE1X GE7RX GE8R</p>	<p>60</p> 	<p>182</p> 
		<p>301</p> 	<p>305</p> 	<p>438</p> 	<p>717</p> 
		<p>SH3</p>	<p>KA1</p>	<p>LW4</p>	<p>BD6 - BD6R</p>





Household keys
Chiavi piatte
Flachschlüssel
Clés plates
Llaves planas
Chaves planas

PER:
FOR:

3F



3

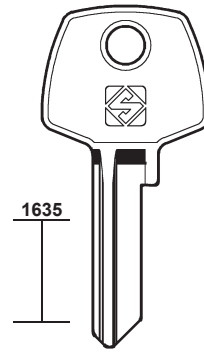
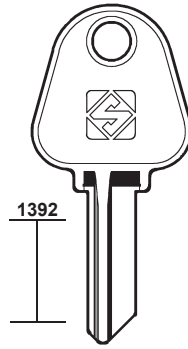
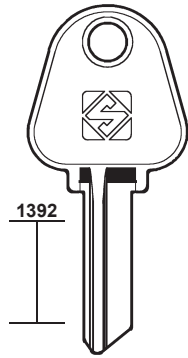
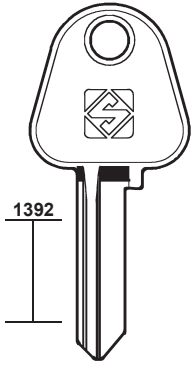

1392

1392

1392

1635

TRF1

TRF1R

TRF2

TRF3

TRF3R

TRF4

PER / FOR

3F (BR)

3M (CN)

333 (IL)

+ CORNI (62)

555 (TW)

CINA (54)

606 (AR)

PER:
FOR:

3F

3M

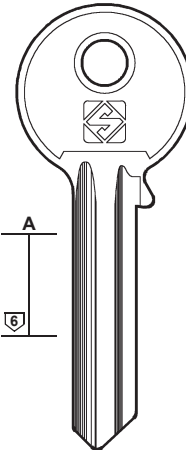
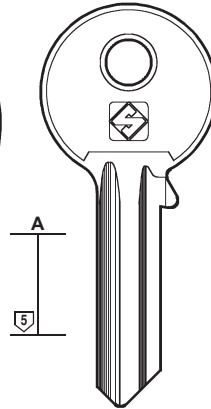
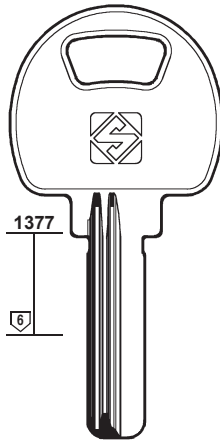
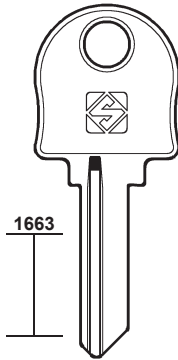
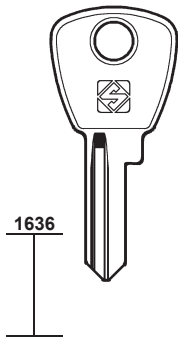

1636

1663

1377

A

A

TRF5R

TRF6R

TRM1R

TRM2

TRM3



PER:
FOR:

333

606

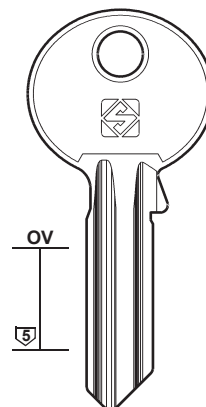
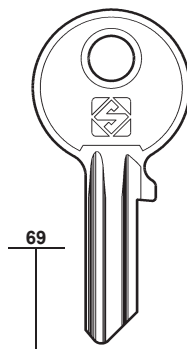
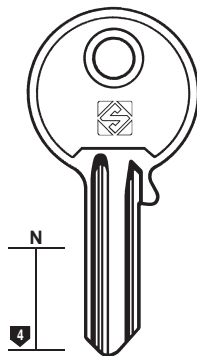
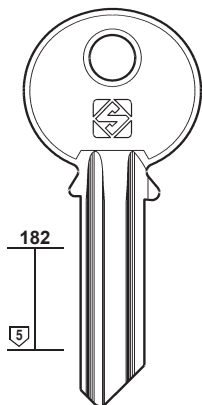

182

N

69

OV

TRE1

TRE2

TRE3

SEI10



4

PER / FOR

aaa (IL)

ABA (GR)

ABBES (GB)
LAS (122)

ABC (ES)
BAGEM

ABLOY (FI)
KITTY
VIRO

PER: aaa
FOR:

AAA1

PER: ABA
FOR:

AAB1

PER: ABC
FOR:

AC1 AC2

BAGEM

PER: ABLOY
FOR:

AY1 AY1P AY11

..... (DX)
..... (SX)
0-1-2-3-4-5-6-7-8-9

KITTY - VIRO

PER: ABLOY
FOR:

AY12 AY16 AY30

..... (DX)
..... (SX)
0-1-2-3-4-5-6-7-8-9

PER:
FOR:

ABLOY



5

PER / FOR

ABLOY (FI)

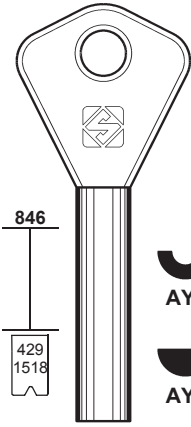

AY14
AY3
AY2

C
..... (DX)
..... (SX)
0-1-2-3-4-5-6-7-8-9

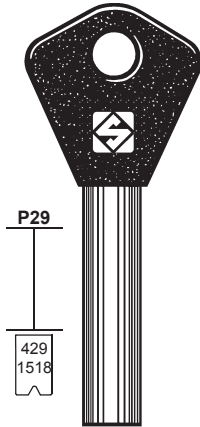

AY2P
AY3P

..... (DX)
..... (SX)
0-1-2-3-4-5-6-7-8-9

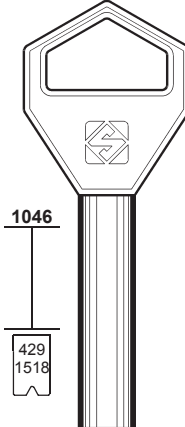

AY13

..... DX
..... (DX)
..... (SX)
0-1-2-3-4-5-6-7-8-9

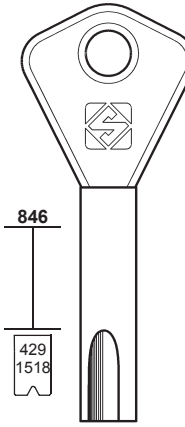

AY15
AAC



PER:
FOR:

ABLOY

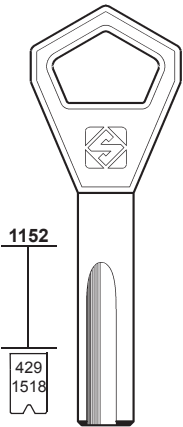

AY17
ACL

..... DX
..... (DX)
..... (SX)
0-1-2-3-4-5-6-7-8-9

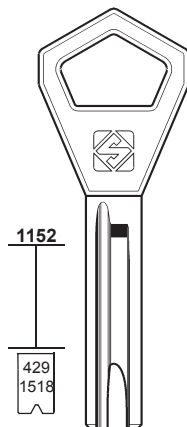

AY18
NAB

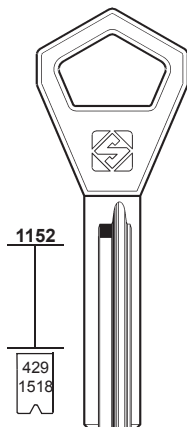

AY20
TAJ

..... DX
..... (DX)
..... (SX)
0-1-2-3-4-5-6-7-8-9

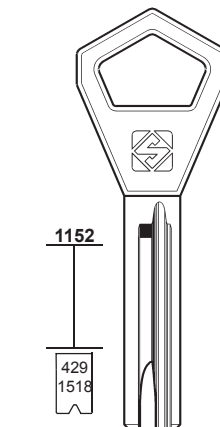

AY21
TAB

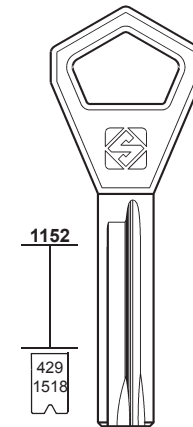

AY23
RAB

..... DX
..... (DX)
..... (SX)
0-1-2-3-4-5-6-7-8-9



PER:
FOR:

ABLOY

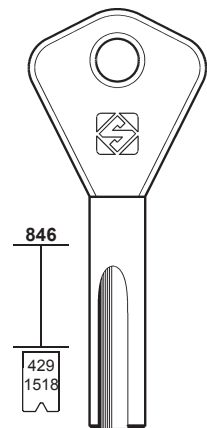

AY24
ACL

..... DX
..... (DX)
..... (SX)
0-1-2-3-4-5-6-7-8-9

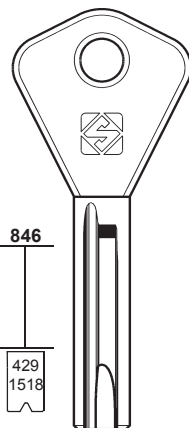

AY25
NAB

..... DX
..... (DX)
..... (SX)
0-1-2-3-4-5-6-7-8-9

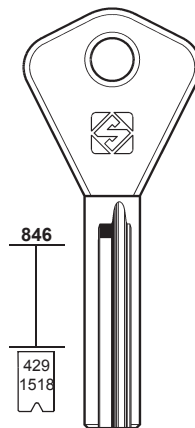

AY26
TAJ

..... DX
..... (DX)
..... (SX)
0-1-2-3-4-5-6-7-8-9

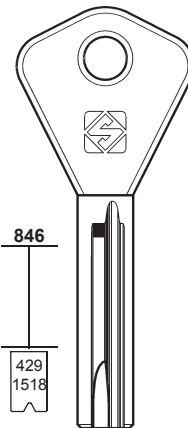

AY27
TAB



6

PER / FOR

ABLOY (FI)

ABT (IT)

VIRO (206)

ABUS (DE)

CISA
JPM
OTHMER
TOP

+ BRICARD (39)

+ CISA (55-56-57-58)

+ G.R. (99)

+ GUARD (100)

+ PFAFFENHAIN (155)

+ YALE (213)

PER:
FOR:

ABLOY

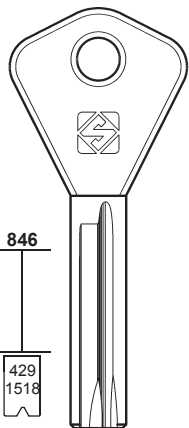

AY28
RAB

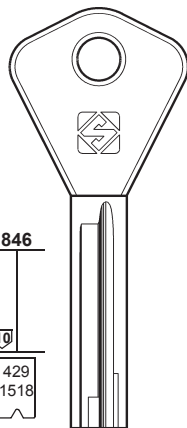

AY29
RAG

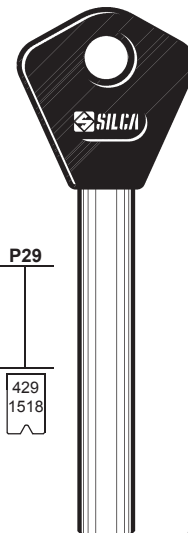

AY10P

..... DX
..... (DX)
..... (SX)
0-1-2-3-4-5-6-7-8-9

..... (DX)
..... (SX)
0-1-2-3-4-5-6-7-8-9



PER:
FOR:

ABUS

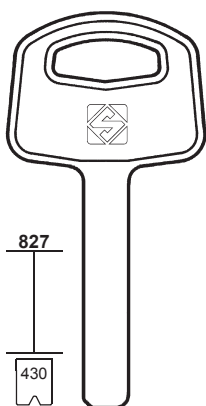

AB32

1-2-3-4-5-6

GRANIT

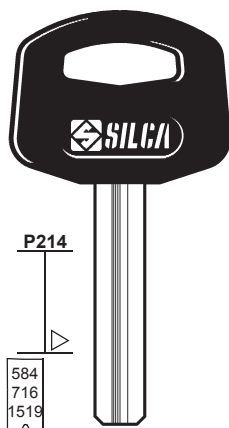

AB38P

1-2-3-4-5-6

ABUS PLUS

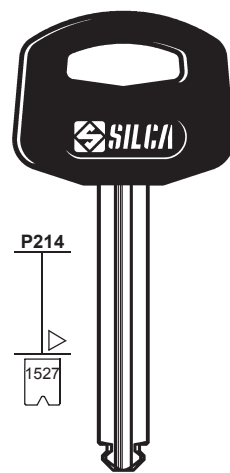

AB60P

1-2-3-4-5-6

PER:
FOR:

ABUS

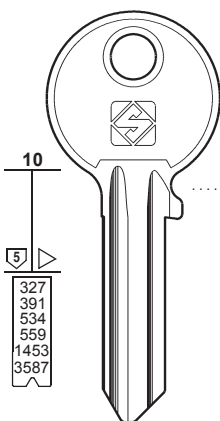

AB1R
.....
1-2-3-4-5-6

AB1
..... 1-2-3-4-5-6
BJ 1-20728
..... 1-2-3-4-5-6-7-8-9
C42
1-2-3-4-5-6-7-8-9

P
00000-02360
AY 1-6032
BA 1-6032
BB 1-6032
BC 1-6032
BD 1-6032
BK 1-6032
BL 1-6032
BM 1-6032
BN 1-6032
BP 1-6032
BQ 1-6032
BR 1-6032
BS 1-6032
BT 1-6032
BU 1-6032
BY 1-6032
SA 1-6032
SB 1-6032

AB10R
F3
BC\SS 1-6032
F2D 1-6032

AB10
F3
... AA 000-999
... AB 000-999
... AF 001-954
... AM 001-988
... AN 001-958
... AV 001-999
... BB 001-636
... BK 001-997
... BL 001-998
... BM 002-999
... BP 001-331
... BQ 001-398
... BR 001-397
... BT 000-999
... BU 000-999
... BV 000-999
... GF 001-892
... GG 001-879
... GH 001-359
... GJ 001-358
... GK 001-308
... GM 001-999
BCISS 1-6032
F2C 1-6032

AB8

AB21
X4D

AB22

AB78R

AB33

AB26
OTHMER
B09

AB8R

AB21R
X4S

AB25R

AB47R

AB34
B49

AB36

AB37

AB44

AB42R

AB63

AB75

AB104R

AB36R

AB37R

AB44R

AB67

JM1
F3

AY-BA
BB-BC
BD-DK
BL-BM
BN-BP
BQ-BR
BS-BT
BU-BY
SA-SB
F3C
..... 1-6032

TOP1R
TOP

JM1R
F3

F3D 1-6032

JM2

JM2R

CISA - JPM - OTHMER - TOP

PER:
FOR:

ABUS

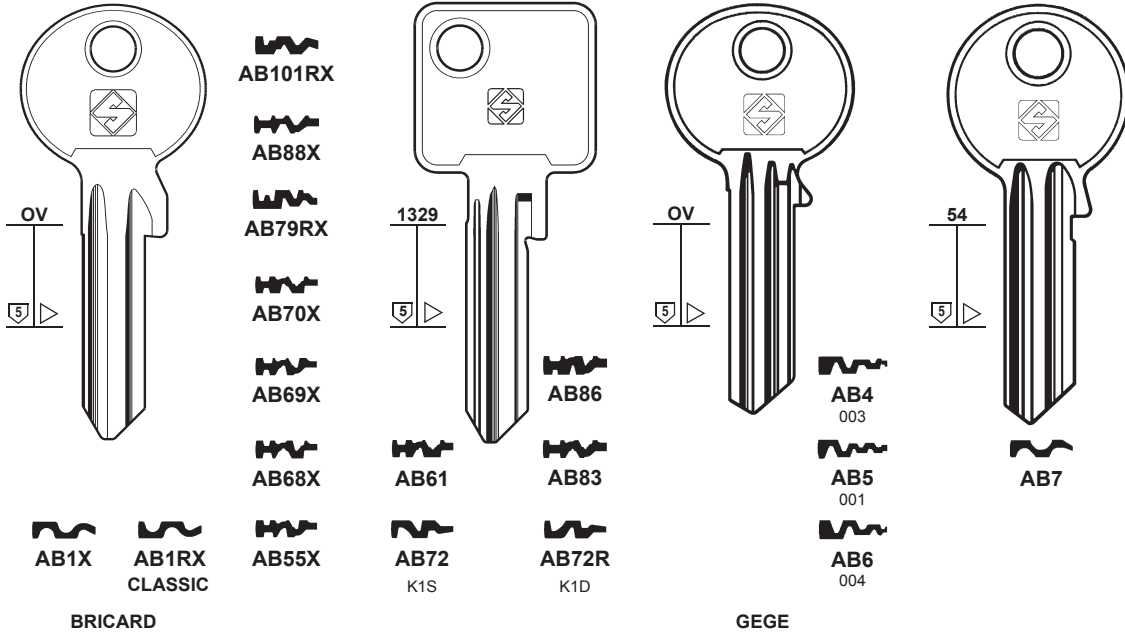

7

PER / FOR

- ABUS (DE)**
 ANCHOR
 BRICARD
 BUFFO
 CISA
 CLASSIC
 GEGE
 JET
 JPM
 KALE
 + BRICARD (39)
 + CISA (55-56-57-58)
 + G.R. (99)
 + GUARD (100)
 + PFAFFENHAIN (155)
 + YALE (212)

PER:
FOR:

ABUS

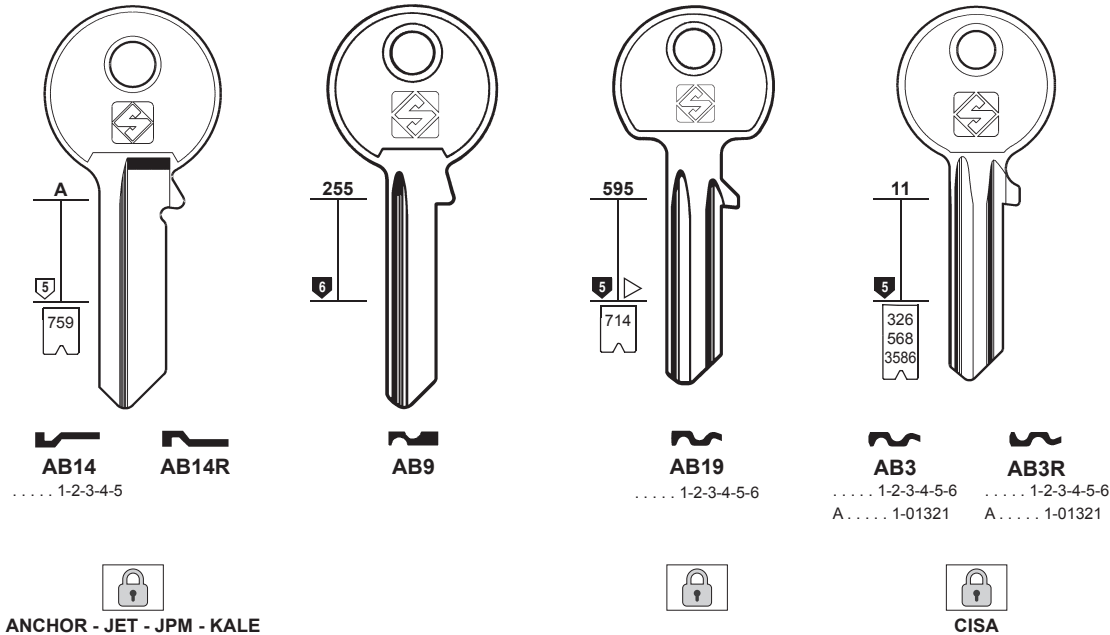

PER:
FOR:

ABUS

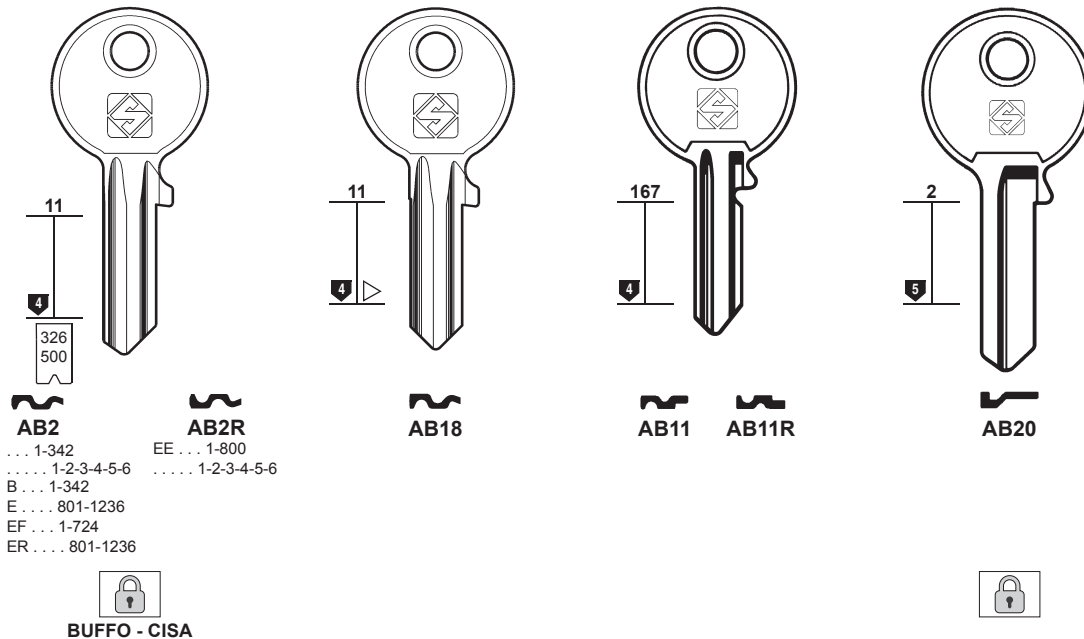



8

PER / FOR

- ABUS (DE)
- ANCHOR
- ARMSTRONG
- BASI
- BURG
- CISA
- FTH
- GUARD
- GUITTEL
- IMP
- MASTER
- ROYAL
- + BRICARD (39)
- + CISA (55-56-57-58)
- + G.R. (99)
- + GUARD (100)
- + PFAFFENHAIN (155)
- + YALE (213)

PER:
FOR:

ABUS

Key 1: Dimensions 37, 5. Bit patterns: AB17, AB17R, AB13, AB13R, FTH. Codes: 758, 764, 765, 2709, 2710.

Key 2: Dimensions 37, 5. Bit pattern: AB29R.

Key 3: Dimensions 36, 3. Bit patterns: AB12, AB12R, AB16, AB16R. Codes: 757, 763, 2706, 2707.

Key 4: Dimensions 36, 3, 4. Bit patterns: AB15, AB15R. Codes: 761, 762, 2702, 2703.

Key 5: Dimensions 639, 3. Bit patterns: AB23, AB23R. Codes: 756, 2704.

Icons: ANCHOR - IMP, ANCHOR - BURG, GUITTEL - IMP - ROYAL, CISA, BASI - GUARD.

PER:
FOR:

ABUS

Key 1: Dimensions 1244, 5. Bit pattern: AB81.

Key 2: Dimensions 806, 5, 327. Bit pattern: AB27. Code: 1-2-3-4-5-6. Icon: mm 50-60.

Key 3: Dimensions 806, 5. Bit patterns: AB30, AB30R.

Key 4: Dimensions 810, 5. Bit pattern: AB31. Icon: lock.

PER:
FOR:

ABUS

Key 1: Dimensions 132. Bit patterns: AB35, AB35R. Icon: lock.

Key 2: Dimensions 132. Bit patterns: AB39, AB39R. Icon: lock.

Key 3: Dimensions 48. Bit pattern: AB41R. Icon: MASTER.

Key 4: Dimensions 48, 5. Bit patterns: AB43, AB43R. Icon: ARMSTRONG.

Key 5: Dimensions 2, 5. Bit pattern: AB45. Icon: lock.

PER:
FOR:

ABUS

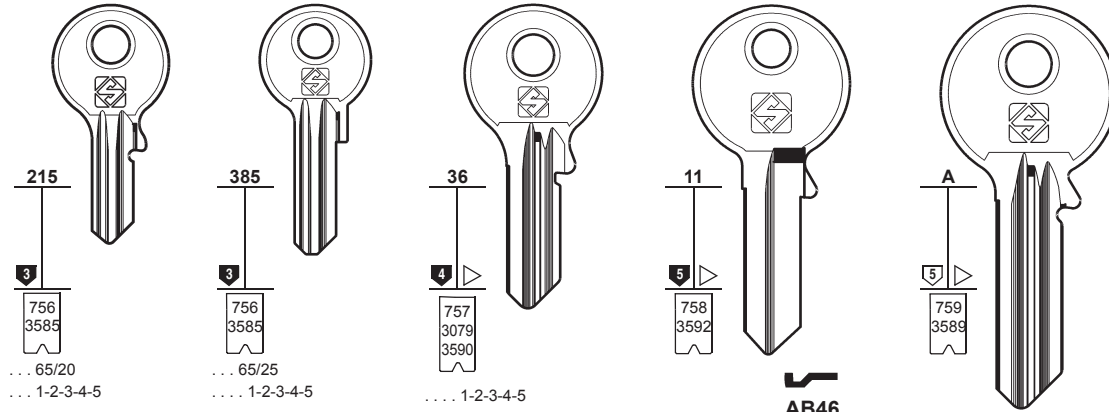

AB50

AB51

AB53

AB52
..... 1-2-3-4-5
..... 1-2-3-4-5-6

AB46
AB71

AB54
..... 1-2-3-4-5



9

PER / FOR

- ABUS (DE)**
BUFFO
FORT
SECURITAL
STEM
- + BRICARD (39)
 - + CISA (55-56-57-58)
 - + G.R. (99)
 - + GUARD (100)
 - + PFAFFENHAIN (155)
 - + YALE (213)

PER:
FOR:

ABUS

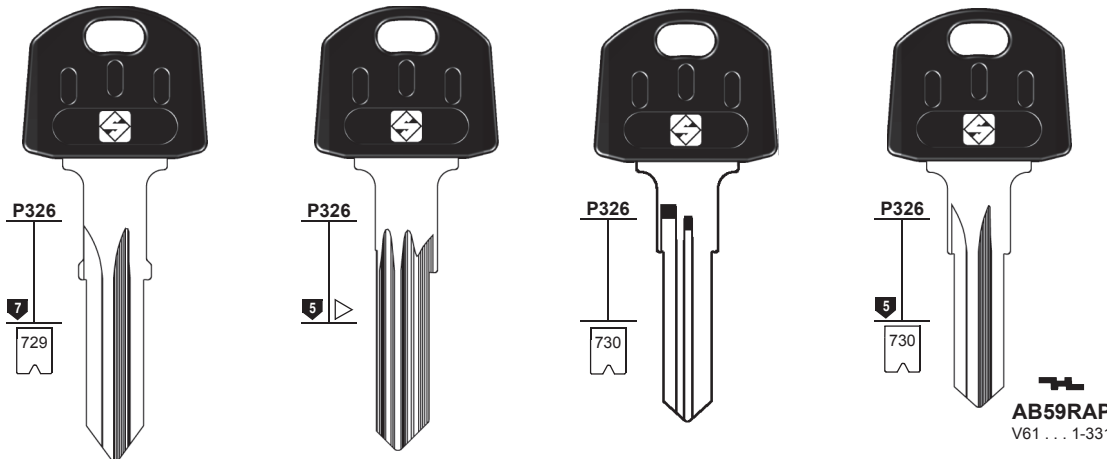

AB57AP
Z71 1-1043
Z72 1-1043

AB57RAP
Z71 1-1043
Z72 1-1043

AB56AP
SL
1-2515

U72
F82 **AB64RAP**
V62 ... 1-331
X61 ... 1-331
X62 ... 1-331

AB65RAP W71

AB58AP

AB58RAP
X61 ... 1-331
X62 ... 1-331
V62 ... 1-331

AB59RAP
V61 ... 1-331



BUFFO

BUFFO



BUFFO

PER:
FOR:

ABUS

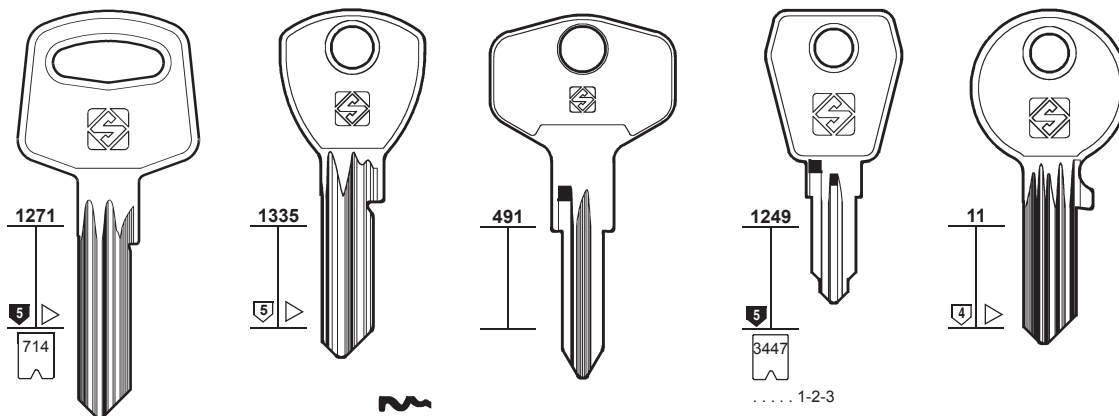

AB102

AB56
SR
1-2515

AB56R
SL
1-2515

AB76

AB76R

AB93R

AB90R
FG

AB85
AL



BUFFO



FORT - SECURITAL



10

PER / FOR

- ABUS (DE)
- CISA
- BRICARD
- + BRICARD (39)
- + CISA (55-56-57-58)
- + G.R. (99)
- + GUARD (100)
- + PFAFFENHAIN (155)
- + YALE (213)

ACE (US)

- CHICAGO (52)

PER:
FOR:

ABUS

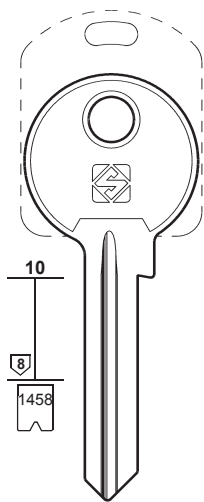

10
8
1458

..... 1205-9533
..... 1717-9020



AB66R
48/49

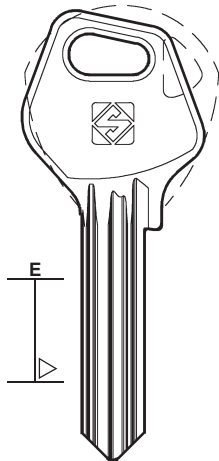

E



AB91

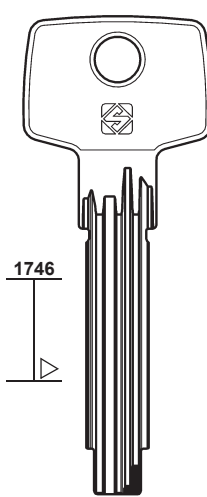

1746



AB109

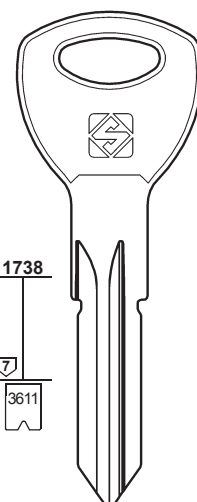

1738
7
3611

NW72 00001-10000
NW72 20001-25312



AB105R



PER:
FOR:

ABUS

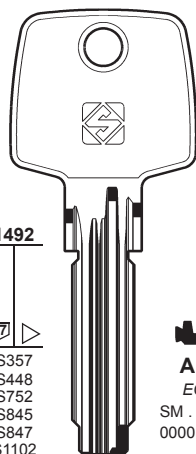

1492
6+7

S357
S448
S752
S845
S847
S1102



AB74

..... 00001-38832
..... 0001-4800
..... (XN005710)1-38832
..... 000001-168000



AB84
EC550

SM
00001-30000



AB77

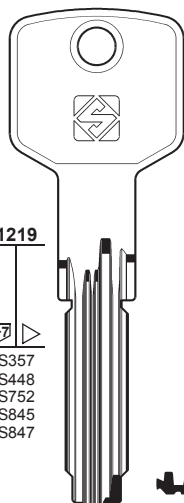

1219
6+7

S357
S448
S752
S845
S847



AB48

D6

..... 00001-38832
..... 0001-4800
..... (XN005710)1-38832
..... 000001-168000

NEW ASTRAL

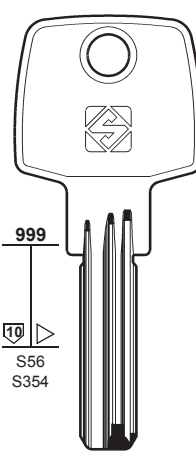

999
10

S56
S354

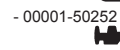

AB40

AAL

EXTRA-CLASSE

- 00001-50252

CISA - BRICARD

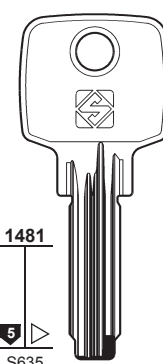

1481
5

S635
S846



AB62

EC75

..... 00001-10000
D8 0001-8000



mm 30-40-50

PER:
FOR:

ABUS

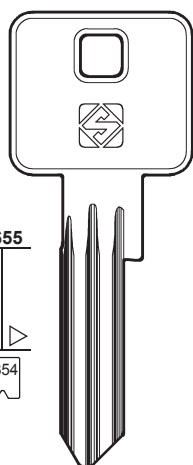

1655
6
2354



AB89

E60

..... 00001-30000



AB95

E60

..... 1234567

E20/E30

..... 00001-30000

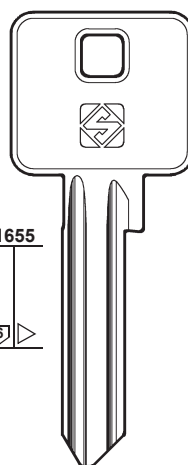

1655
6



AB98

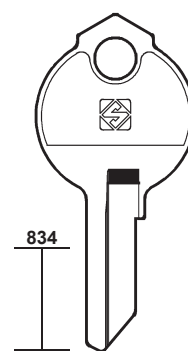

834



AB100



AB100R

PER: **ADAMS RITE**
FOR:

ADS

AEP

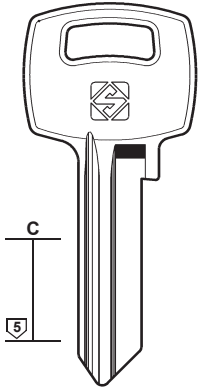

ADT1

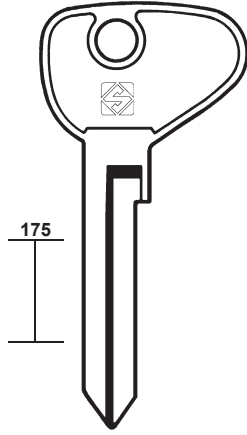

AD1

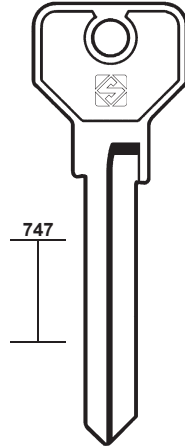

AD2

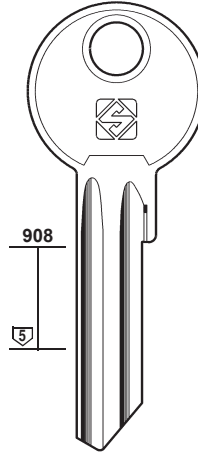

AEP1

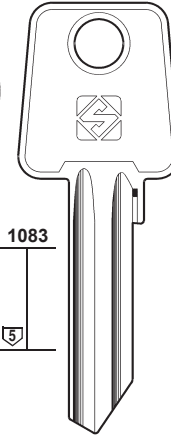

AEP2



11

PER / FOR

ADAMS RITE (US)

ADEMCO (US)

CHICAGO (52)

ADS (DE)

AEP (LV)

AGA (ES)

ARREGUI
BTV
CASAS
COLOMENCA
FB
GARI
MECALUX
SERRALLER
SUYOKA
TERCA

AGB (IT)
SAVIO

PER:
FOR:

AGA

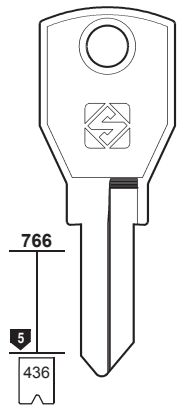

AGA1
B ...
901-926

AGA2
D ...
901-926

AGA4
G ... 501-526
G ... 901-926

AGA5
E ... 501-526
E ... 901-926

AGA1R
A ...
901-926

AGA2R
C ...
901-926

AGA4R
H ... 501-526
H ... 901-926

AGA5R
F ... 501-526
F ... 901-926

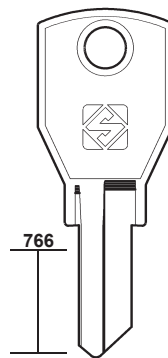

AGA3

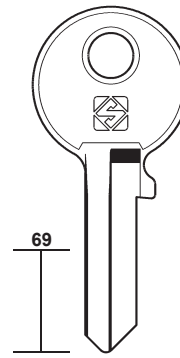

AGA25

AGA25R



BTV - MECALUX - SUYOKA



ARREGUI

PER:
FOR:

AGA

AGB

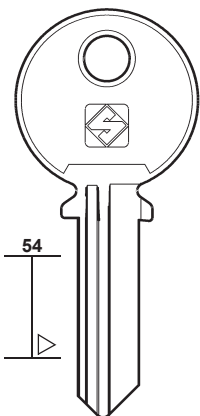

AGA6

GARI

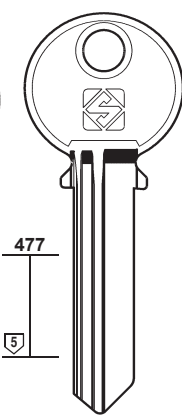

AGA8

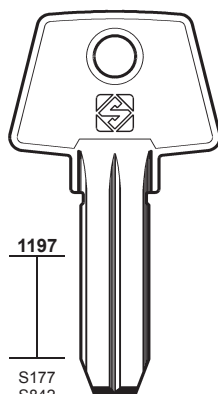

S177
S842
S897
S898
S971
S972
S971
S1020

AGA7

..... 1-2-3-4-5

COLOMENCA - FB
SERRALLER - TERCA

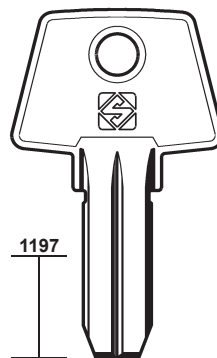

S841
S895
S896

AGA9

CASAS

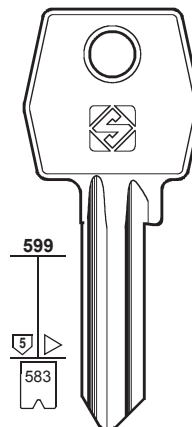

AGB1

SAVIO

AGB1R

.....
1-2-3-4-5-6-7



12

PER / FOR

AGB (IT)
SAVIO

AGE (JP)

PER:
FOR:

AGB

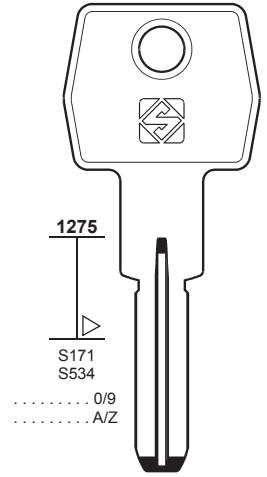
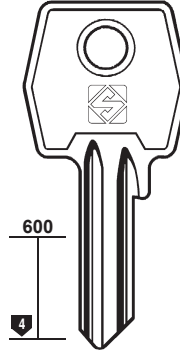
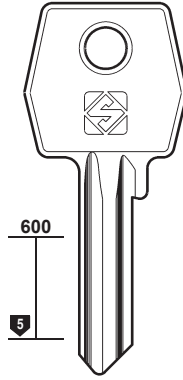
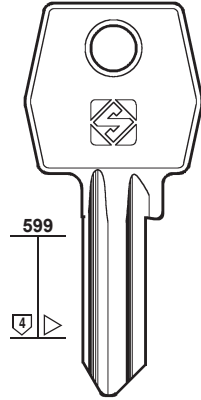

AGB2 AGB2R

SAVIO



AGB3 AGB3R

SAVIO



AGB4 AGB4R



AGB5
SCUDO 9000



PER:
FOR:

AGB

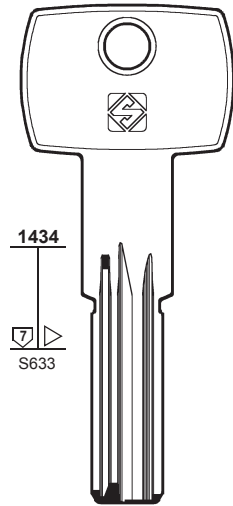

S633

HNH
AGB8

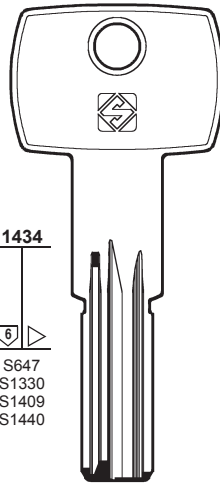

S647
S1330
S1409
S1440

HNH
AGB9

..... 0/9
..... A/Z

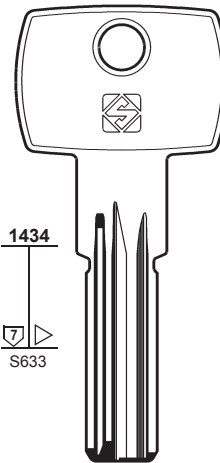

S633

HNH
AGB6
SCUDO 7000

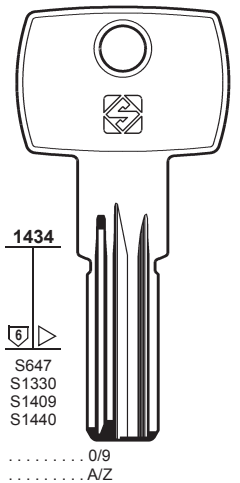

S647
S1330
S1409
S1440

..... 0/9
..... A/Z

HNH
AGB7
SCUDO 5000

SCUDO



PER:
FOR:

AGE

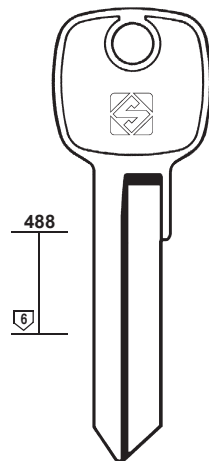

488

6

AGE4R AGE5R

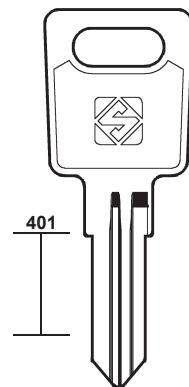

401

AGE6

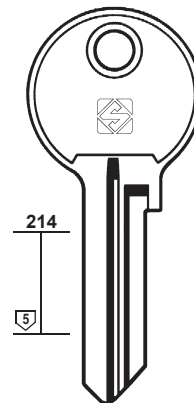

214

5

AGE2

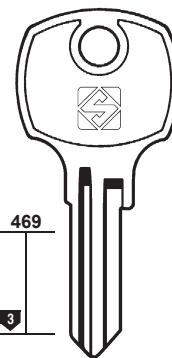

469

3

AGE3

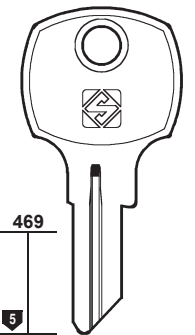

469

5

AGE1 AGE1R



PER:
FOR: **AGENT**

AGUIA

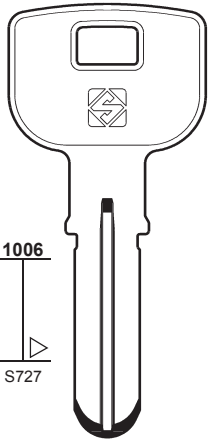

AGN1

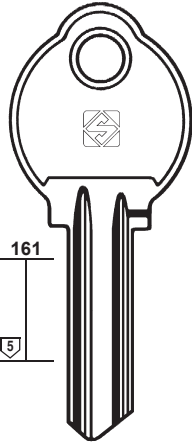

AG1

AG1R

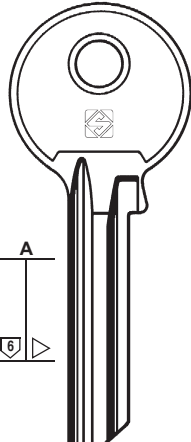

AG4

AG4R

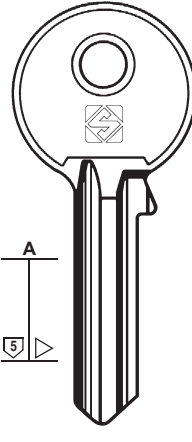

AG2

AG2R

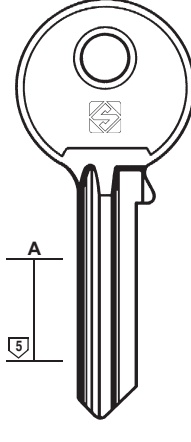

AG3

AG3R

AG7

AG7R



13

PER / FOR

AGENT (JP)

AGUIA (PT)

**AISPUTE (LV)
KURZEMES**

**AKIRA (IT)
YETI (218-219)**

**AKKA (IT)
WALLY (207)**

AL (PT)

AL AHRAM (EG)

PER:
FOR:

AGUIA

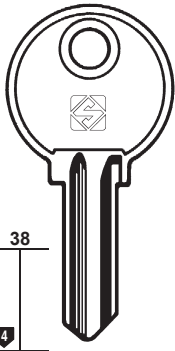

AG5

AG5R

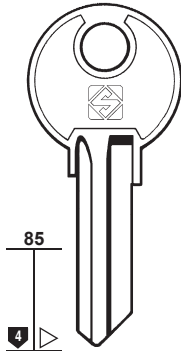

AG6

AG6R

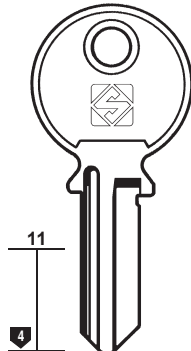

AG8

AG8R

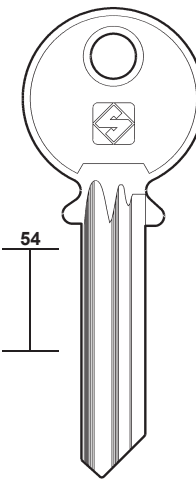

AG9

AG9R

AG10

PER:
FOR:

AISPUTE

AL

AL AHRAM

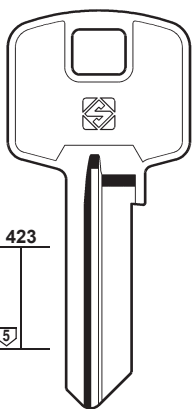

ASU1R

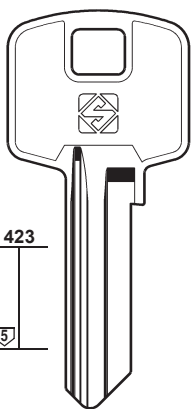

ASU2

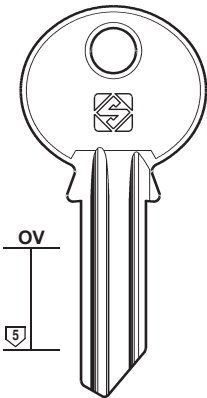

AL1

AL1R

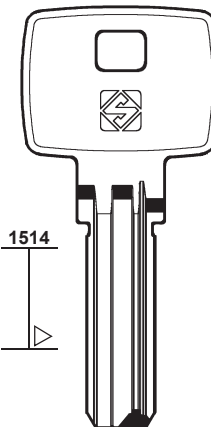

AHR2



KURZEMES



14

PER / FOR

ALA (IT)
CISA
+ CISA (55-57)
+ KESO (115)

ALDRIDGE E. (GB)
ASEC SECURITY

PER:
FOR:

ALA

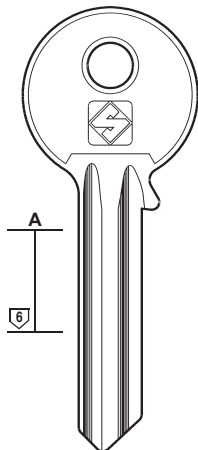

AA6 AA6R

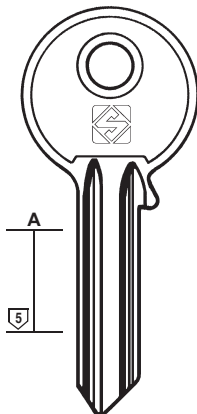

AA5 AA5R

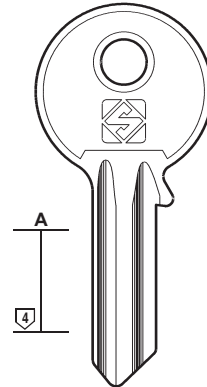

AA1 AA1R



PER:
FOR:

ALA

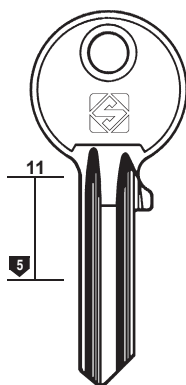

AA2 AA2R

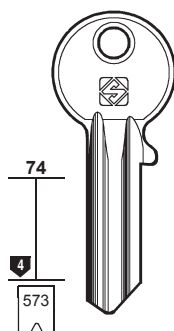

AA3 AA3R
.....
1-2-3-4-5-6-7

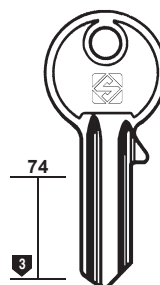

AA4
AA4R

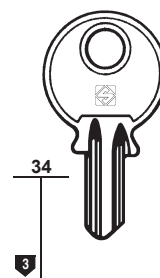

CS12
CS12R



PER:
FOR:

ALDRIDGE E.

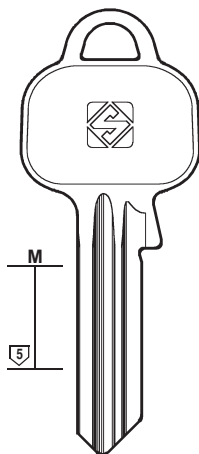

AE1R

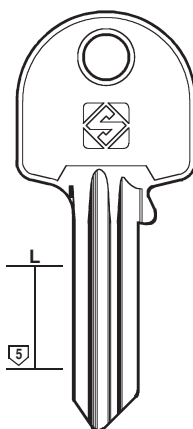

AE2R

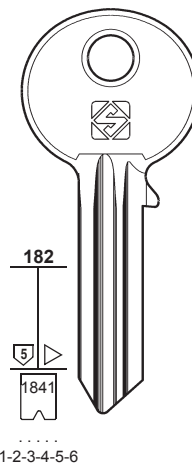

.....
1-2-3-4-5-6

ASEC1

ASEC SECURITY

PER:
FOR: **ALDRIDGE E.**

ALFA

ALIANÇA



15

PER / FOR

ALDRIDGE E. (GB)
ASEC SECURITY

ALF (FR)
CISA (55)

ALFA (SE)

ALI (TW)
CINA (54)

ALIANÇA (BR)

ALKE (IT)

ALLGOOD (GB)
CENTURY (46)

ALMET (US)
ARROW (20)

ALPHA (IT)
CHICAGO (52)

PER:
FOR: **ALKE**

ALPHA

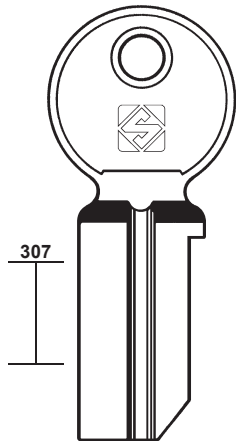

ALK1

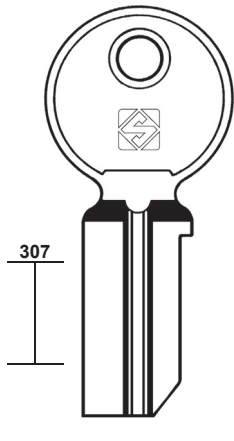

ALK2

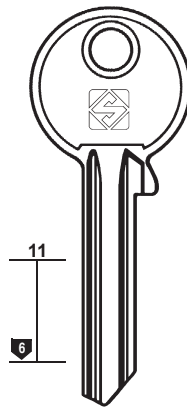

ALP2

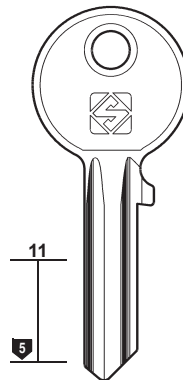

ALP11

PER:
FOR: **ALPHA**

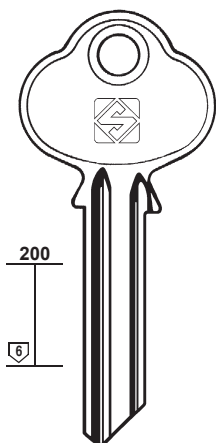

ALP3

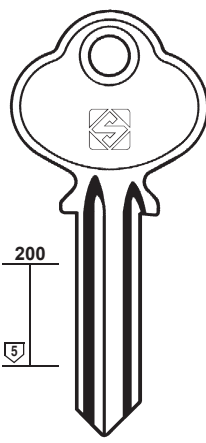

ALP10

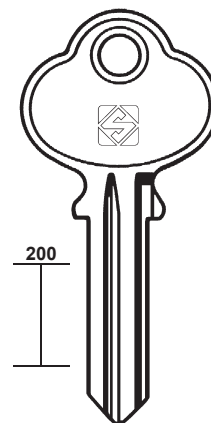

ALP1



16

PER / FOR

ALPHA (IT)

FEB
HMP
JD
LINCE
MONACOR
SANY
VISONIC
+ CHICAGO (51)

ALSO (US)

JUNKUNC (112)
STS (177)

ALUBOX (IT)

ALUNORM (IT)

CORBIN (60)

AM (IT)

POTENT (156)

AMARO LIMITADA (PT)

PICARDIE

AMELCO (BR)

PER:
FOR:

ALPHA

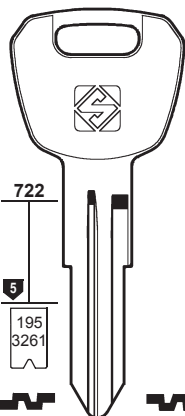

ALP4

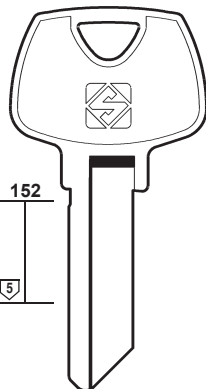

ALP4R

S ... 301-600



ALP9

7000 ...



MONACOR - SANY - VISONIC



ALP9R

LINCE
JD



ALP6R

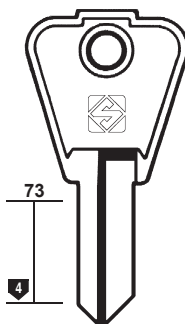

ALP5R



HMP

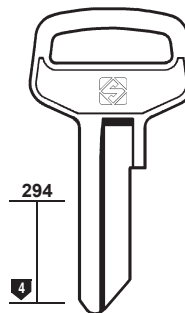

ALP8R



HMP

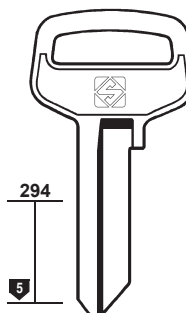

ALP7R



HMP

PER:
FOR:

ALPHA

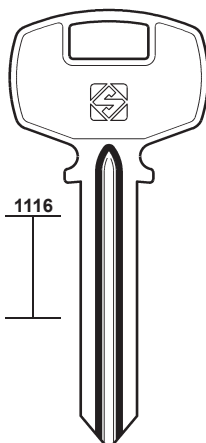

ALP12

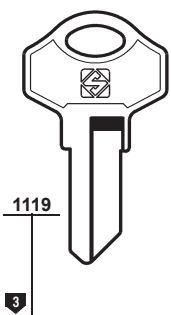

ALP13R

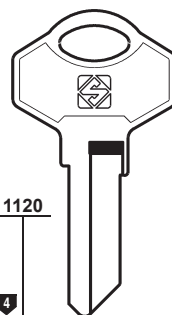

ALP14R

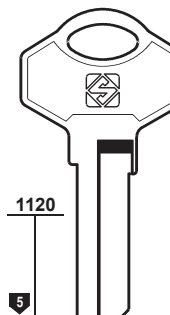

ALP15R

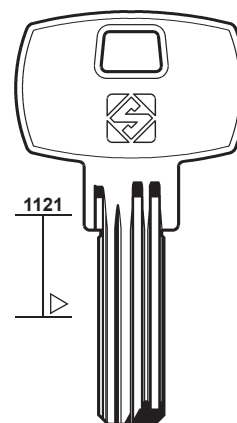

ALP16



PER:
FOR:

ALUBOX

AMARO LIMITADA

AMELCO

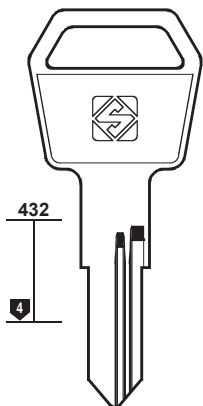

ALU1

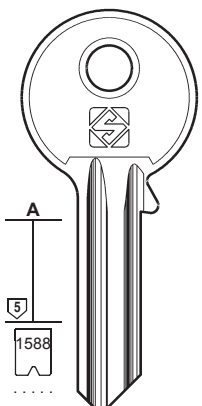

1588

6-5-4-3-2-1



ALM1



ALM1R

PICARDIE

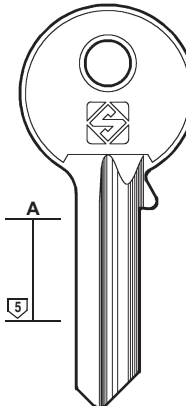

AMC2R

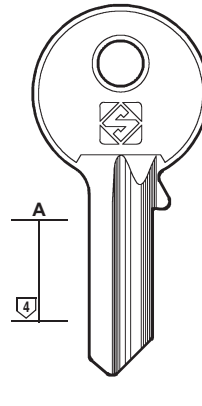

AMC1R

PER:
FOR: **AMELCO**

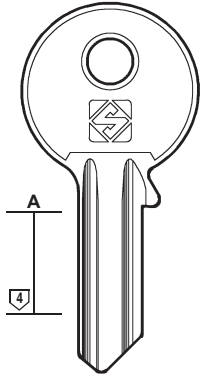

AMC3

AMIG

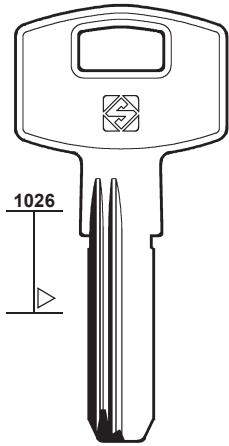

AMG3R

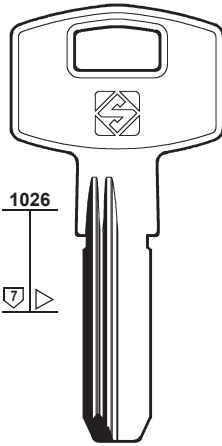

AMG1R

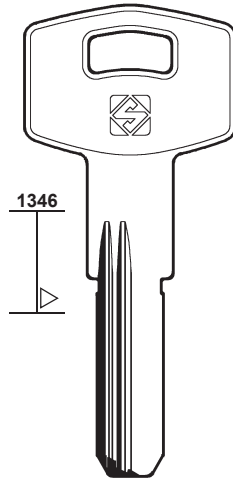

AMG2R



17

PER / FOR

AMELCO (BR)

AMERICAN (US)
JUNKUNC (112)

AMEROCK (US)
ARROW (20)

AMIG (ES)

ANCHOR (SE)
ANKERSLOT
 + **ABUS (7-8)**
 + **ANKERSLOT (17)**

ANHSIN (HK)

ANKERSLOT (NL)
ANCHOR
LITTO
ODA
 + **ANCHOR (17)**
 + **LITTO (125)**

PER:
FOR:

ANCHOR

ANHSIN

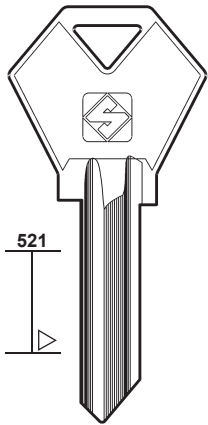

ACR1

ANKERSLOT

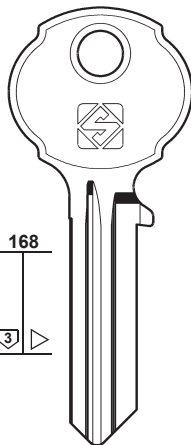

ACR2

ANKERSLOT

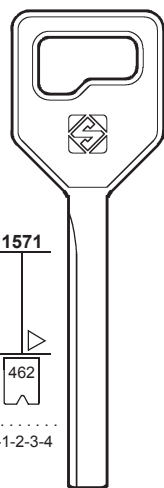

ACR3

0-1-2-3-4

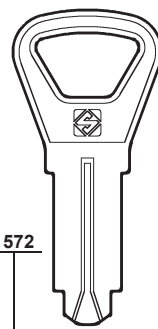

ACR4

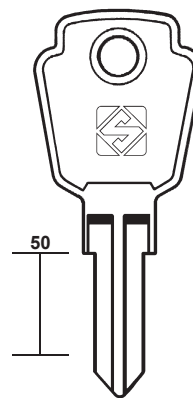

AH1

PER:
FOR:

ANKERSLOT

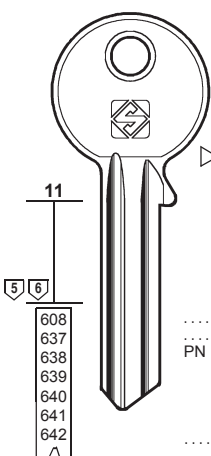

AKR6

AKR3

A
 1-2-3-4-5-6-7
 1-2-3-4-5-6-7
 PN 0/9 1-2-3-4-5-6-7

AKR3R

A
 1-2-3-4-5-6-7
 1-2-3-4-5-6-7
 ... L ... 1234567RSTUVWX



ODA

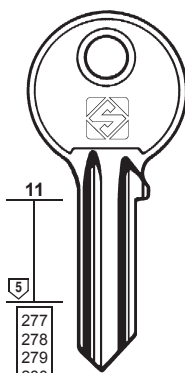

AKR2

277
278
279
280
533
766

E A
 F B
 K C
 G V
 1-2-3-4-5-6-7 1-2-3-4-5-6-7



LITTO

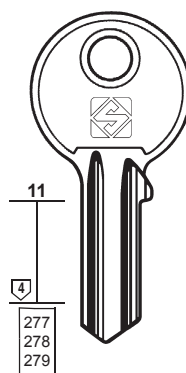

AKR1

277
278
279

..... 1011-7077
 B 1-2-3-4-5-6-7
 E 1-2-3-4-5-6-7
 F 1-2-3-4-5-6-7
 K 1011-7077
 V 1-2-3-4-5-6-7
 K ... 111-888



ANCHOR - LITTO - ODA



AKR7

277
278

..... 1011-7077
 B 1-2-3-4-5-6-7
 E 1-2-3-4-5-6-7
 F 1-2-3-4-5-6-7
 K 1011-7077
 K ... 111-888





18

PER / FOR

ANKERSLOT (NL)
+ ANCHOR (17)
+ LITTO (125)

ANLO (FR)
+ GLOBE (97)

ANTAR (FR)
VEGA
+ RONIS (161)

APEKS (RU)

PER:
FOR:

ANKERSLOT

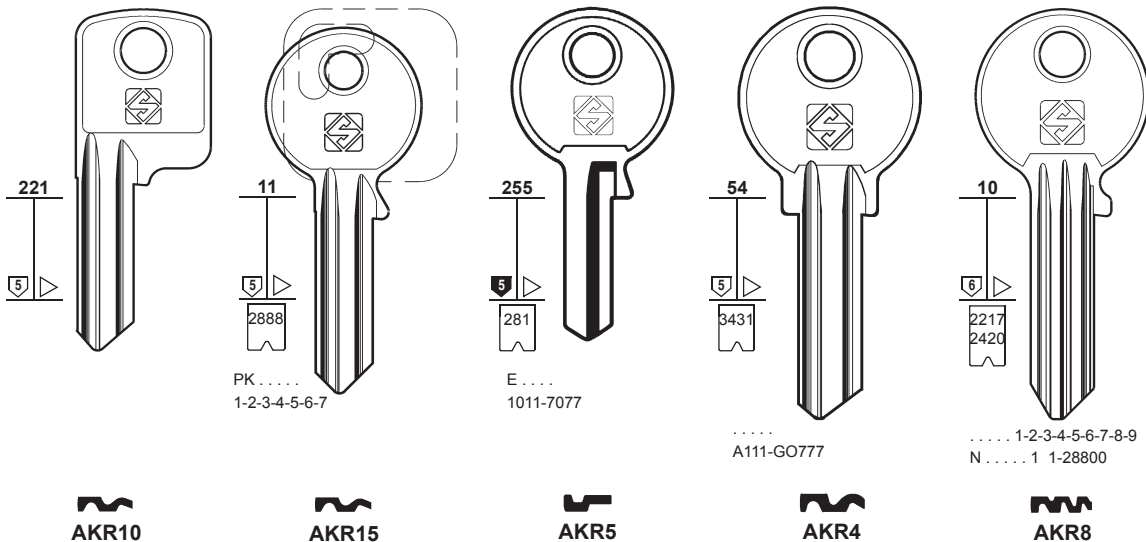

PER:
FOR:

ANKERSLOT

ANTAR

APEKS

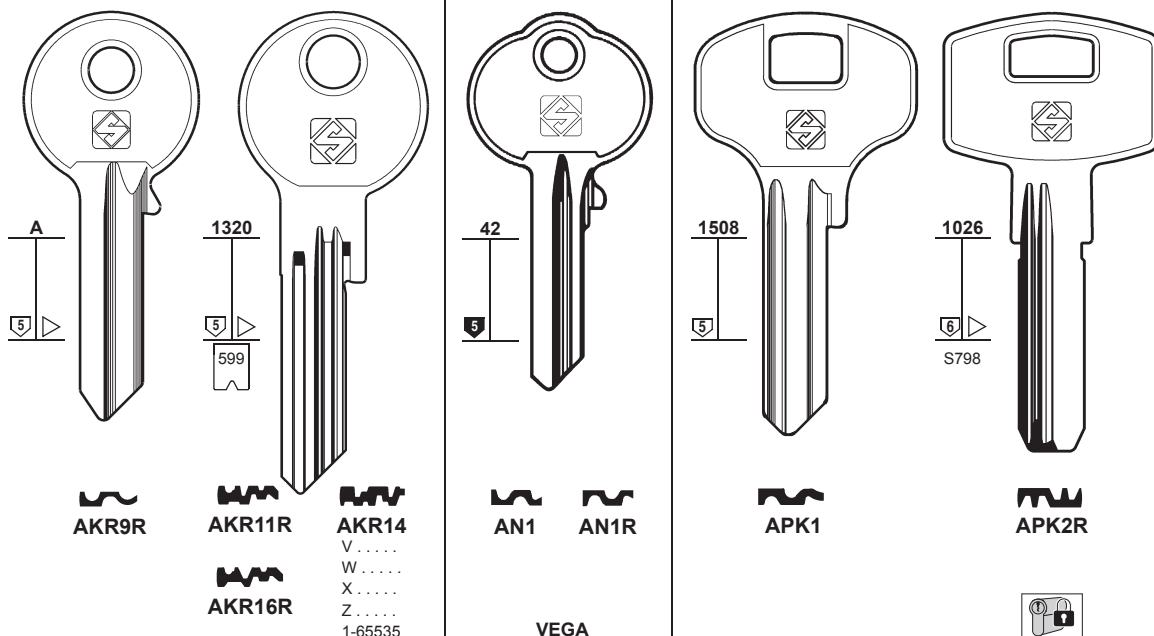

PER:
FOR:

APEKS

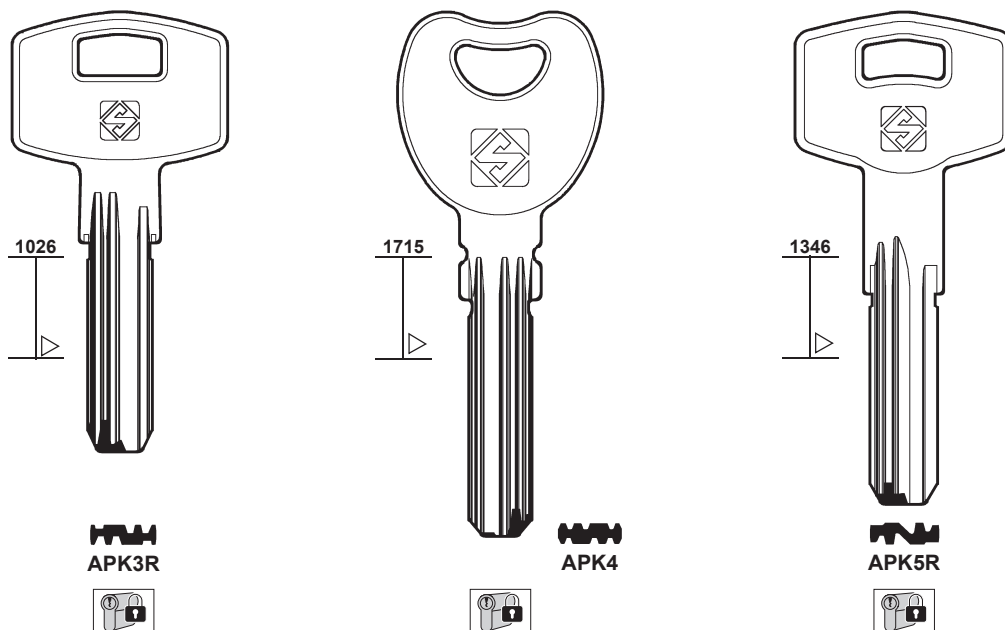

PER:
FOR:

AQUILA

AREL (GB)

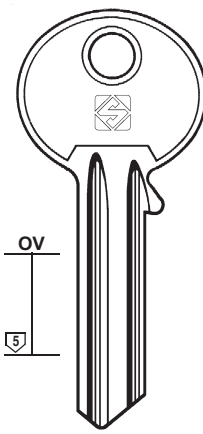
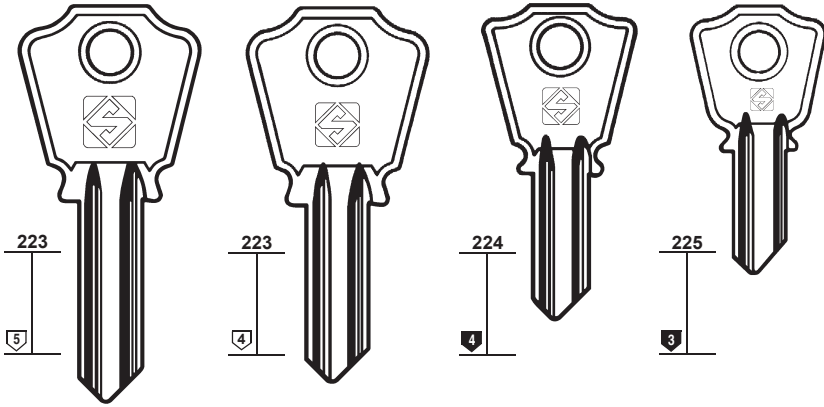

19

PER / FOR

AQUILA (IT)

AREL (GB) (IR)

ARFE (ES)

STS

+ FORT (90)

+ STS (177)

ARMOR (FR)

+ RONIS (161)

ARMSTRONG (CZ)

+ ABUS (8)

ARNOV (FR)

+ ZENITH (222)

AROUCA (BR)

ARREGUI (ES)

+ AGA (11)

+ FAC (84)

PER:
FOR:

AREL (I)

ARFE

ARMSTRONG

AROUCA

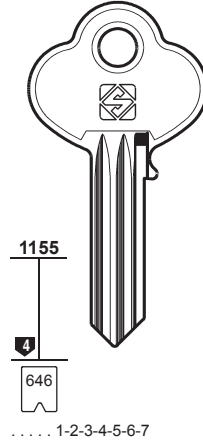
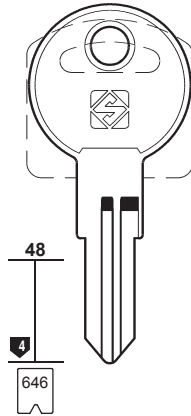
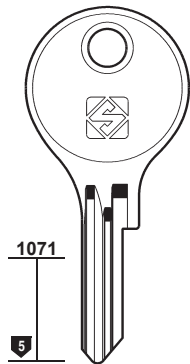
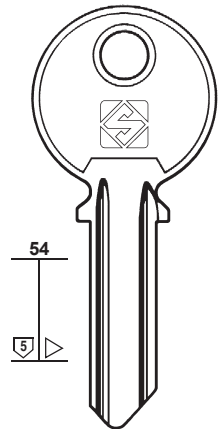

STS

PER:
FOR:

AROUCA

ARREGUI

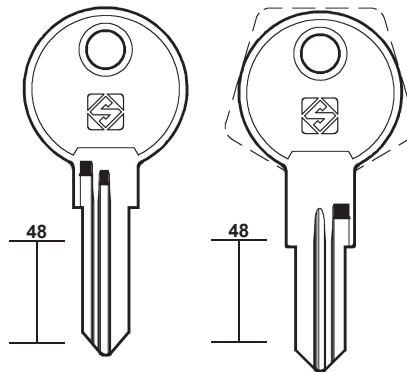
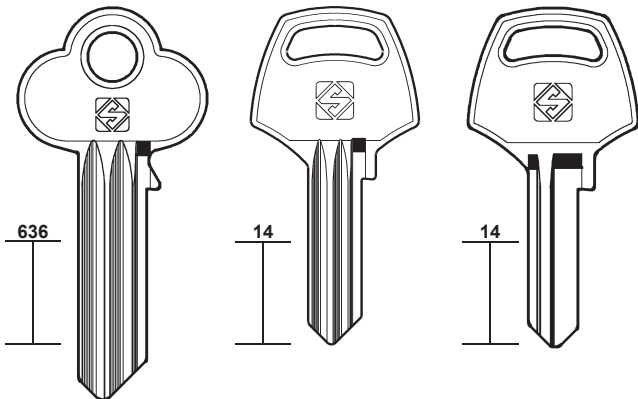



20

PER / FOR

ARROW (US)
ALMET
AMEROCK
DOMINION
FORT
LG

ARSENJEVSK (RU)

ASEC SECURITY (GB)
ALDRIDGE E. (14-15)

ASIA (TW)
TWRHONB
+ YETI (218-219)

ASIAN (TW)

ASPA (NL)
+ DOM (70-71)

PER:
FOR:

ARROW

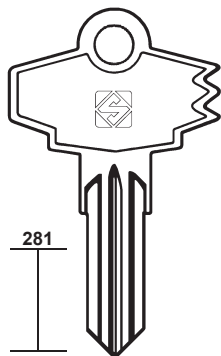

281



AW1



AW3



AW2



AW4



DOMINION - FORT - LG

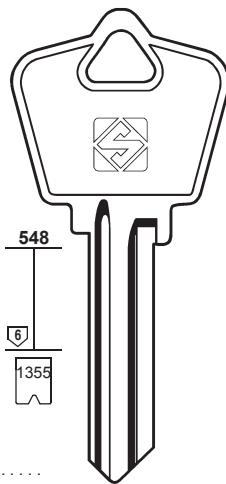

548

6

1355

0-1-2-3-4-5-6-7-8-9



AW5

K7

AMEROCK

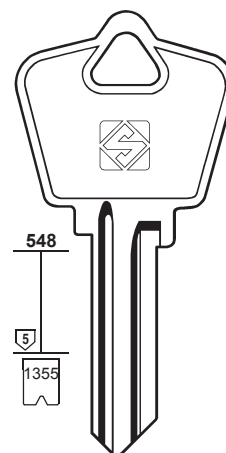

548

5

1355

0-1-2-3-4-5-6-7-8-9



AW6

K7-5

ALMET

PER:
FOR:

ARROW

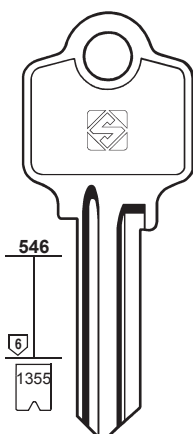

546

6

1355

0-1-2-3-4-5-6-7-8-9



AW7

K2

ALMET

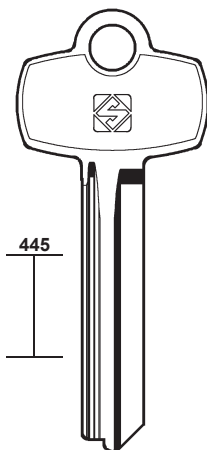

445



AW22

1D



AW23

1C

ARSENJEVSK

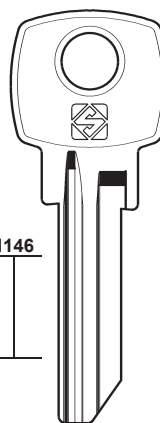

1146



ARS1

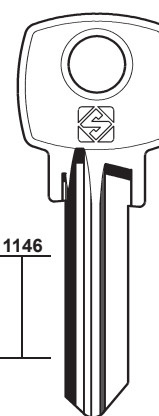

1146



ARS2

PER:
FOR:

ASIA

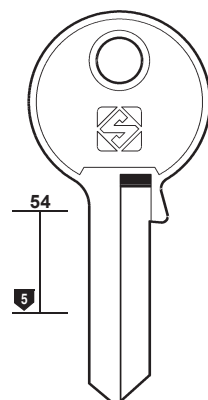

54

6

1355



AS1



mm 45
TWRHONB

ASIAN

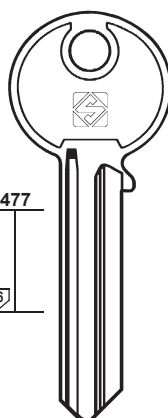

477

6

1355



ASN1



ASPA

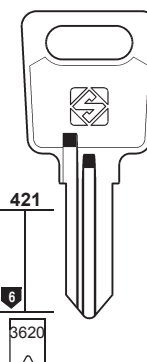

421

6

1355



APA1R
2U ... 1-748

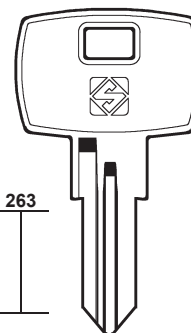

263



APA2R

PER:
FOR:

ASSA



21

PER / FOR

ASSA (SE)
TEKA
+ RUKO (162)
+ TEKA (181)

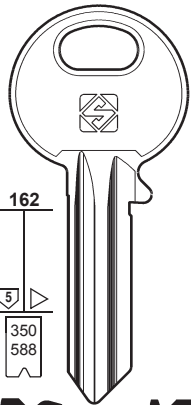

ASS63
22001

ASS63R

ASS6
20201

ASS6R
20301

..... 0-1-2-3-4-5-6-7-8-9-A-B-C
..... D-0-1-2-3-4-5-6-7-8-9-A-B-C

TEKA

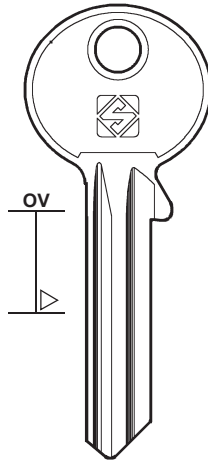

ASS186

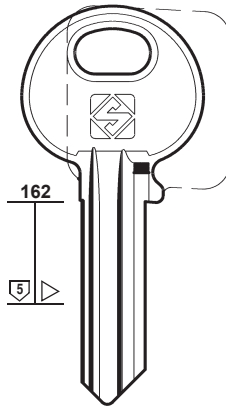

ASS137
22401

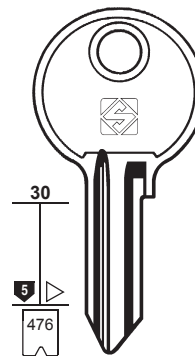

... 151-200
..... 0-1-2-3-4-5-6

ASS47
21202

PER:
FOR:

ASSA

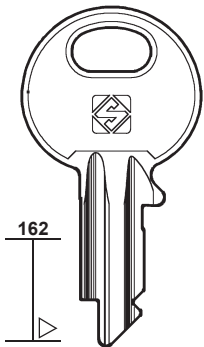

ASS181

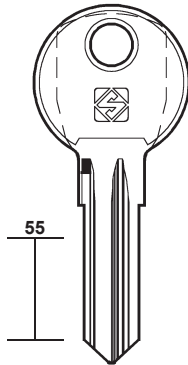

ASS187R

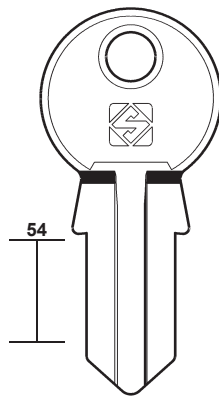

ASS149

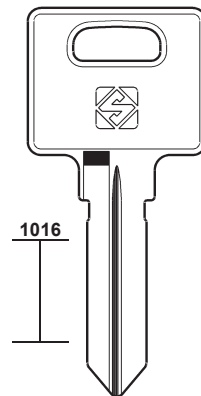

ASS148

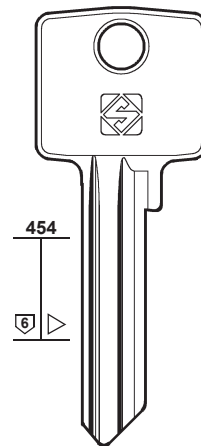

ASS188

PER:
FOR:

ASSA

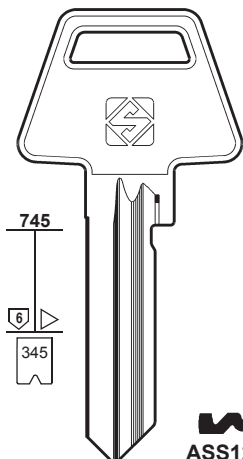

ASS155
PK

ASS122R
UM

ASS155R
UK

ASS142 TW
123456789
05-04

ASS143
05-05

ASS144 TW
123456789
05-13

ASS145
14-01

ASS146
14-09

ASS147
14-25

ASS150
11-08

ASS151
11-01

ASS152
11-32

ASS153
11-14

ASS154
11-12

ASS172
05-14

ASS174
14-33

ASS175R
UL

ASS176
TM

ASS177
TK

ASS178
TL



22

PER / FOR

ASSA (SE)

+ RUKO (162)

+ TEKA (181)

PER:
FOR:

ASSA

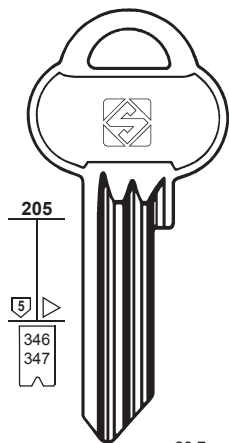

560.
mm 28,7

..... 1-2-3-4-5-6-7
..... 1-2-3-4-5-6-7-8

- B ASS9R
- F ASS31R
- G ASS11
- K ASS33
- N ASS2
- R ASS10R

- A ASS9
- E ASS31
- M ASS11R
- L ASS33R
- P ASS2R
- S ASS10

PER:
FOR:

ASSA

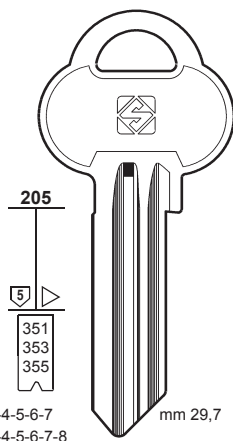

..... 1-2-3-4-5-6-7
..... 1-2-3-4-5-6-7-8

560.

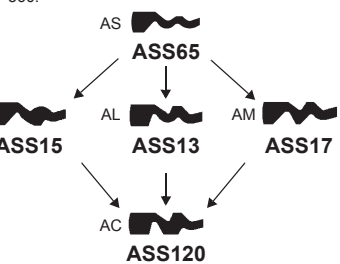

- U ASS7
- V ASS35R
- Z ASS37
- NN ASS44
- W ASS7R
- T ASS35
- X ASS37R
- PP ASS44R
- D ASS64
- RR ASS69
- MM ASS68R
- FG ASS180R
- H ASS64R
- SS ASS69R

5FG 10000-99809

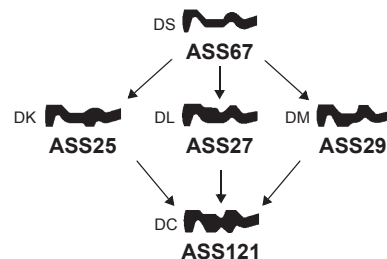
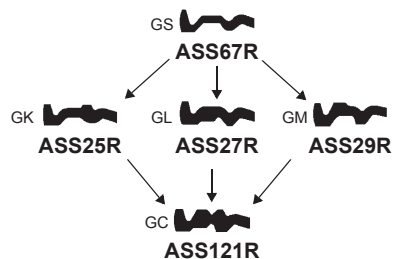
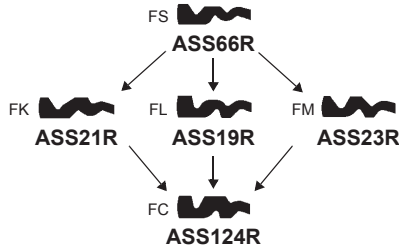
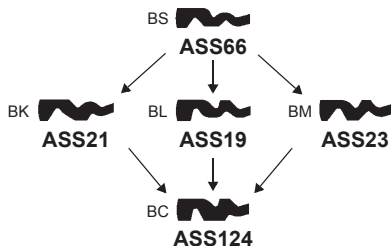
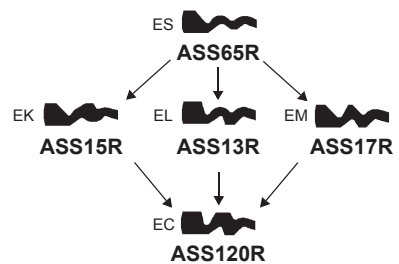

PER:
FOR:

ASSA



23

PER / FOR

ASSA (SE)

+ RUKO (162)

+ TEKA (181)

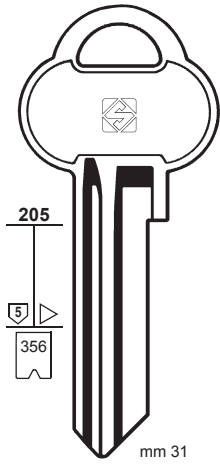

560.
..... 1-2-3-4-5-6-7

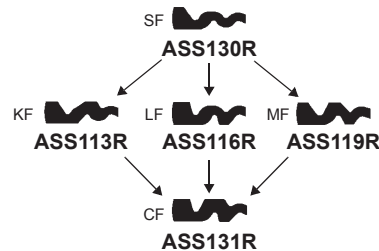
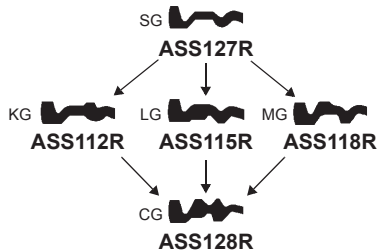
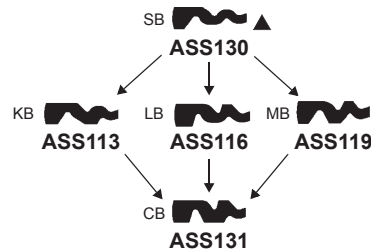
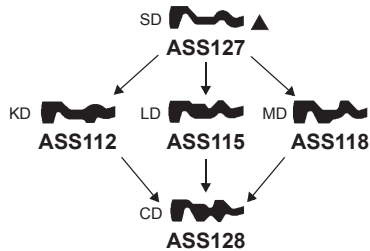
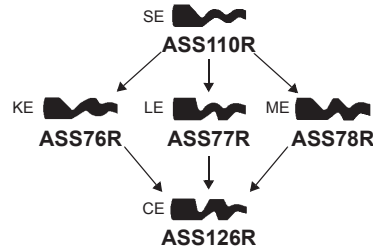
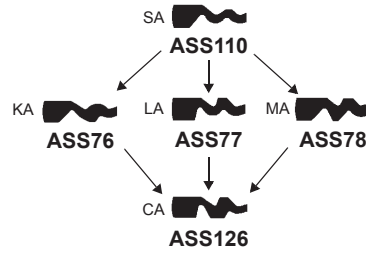

PER:
FOR:

ASSA

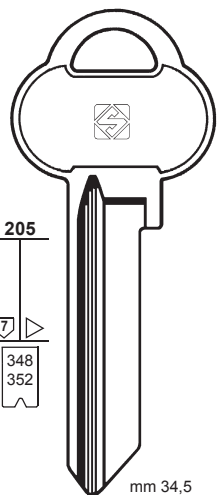

760.
..... 1-2-3-4-5-6-7

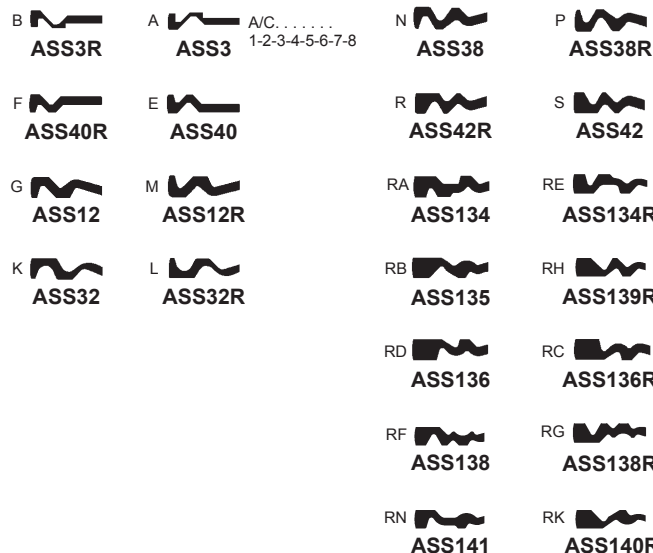



PER:
FOR:

ASSA

24

PER / FOR

ASSA (SE)

+ RUKO (162)

+ TEKA (181)

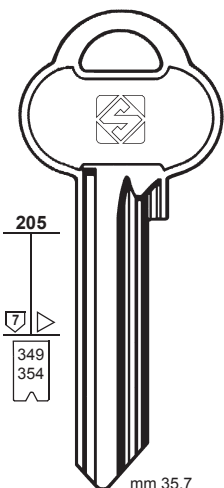

205



mm 35,7

760.



ASS108

..... 1-2-3-4-5-6-7
..... 1-2-3-4-5-6-7-8



ASS4



ASS4R



ASS8



ASS8R



ASS34R



ASS34



ASS36



ASS36R



ASS45



ASS45R



ASS39



ASS39R



ASS109



ASS48R

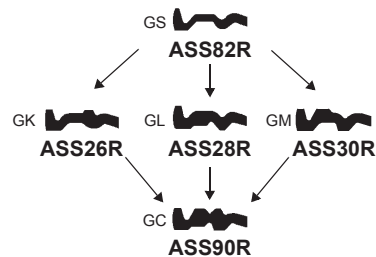
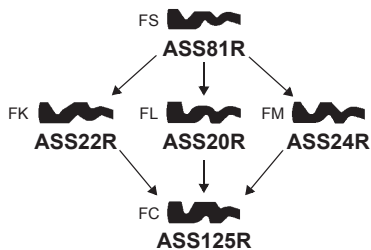
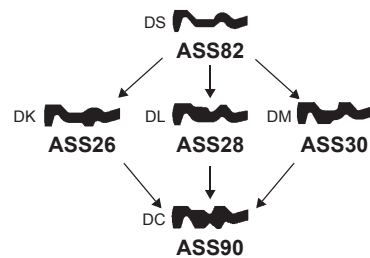
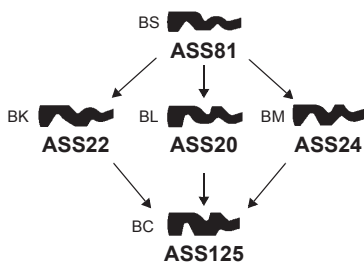
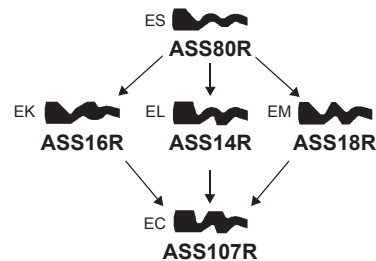
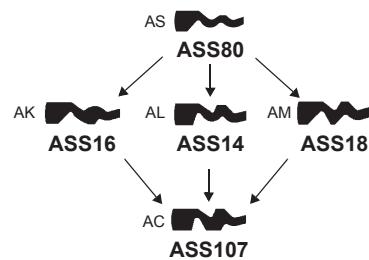

PER:
FOR:

ASSA



25

PER / FOR

ASSA (SE)
HABO
+ RUKO (162)
+ TEKA (181)

ASTRA (AU)

ATAL (FR)
 KIFERM (117)
 LAS (121)
 L & F (128)
 RENZ (159)
 VACHETTE (198)

ATAY (RU)

ATLAS (FR)
 SUREX (178)

ATRA (IT)
 ISEO (109)

ATP (IT)
 CITY (58)

AUBERT (FR)
 ZENITH (222)

AUDOLI (IT)

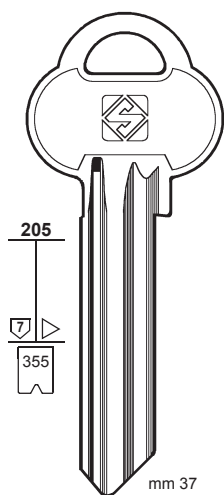

1DG 1-83499
0FG 10000-99809
0DG 1-99999
DS 1-78678
DJ 1-1234567
SE 00001-43800
..... 1-2-3-4-5-6-7
..... 1-78670

- | | |
|------------------|-------------------|
| DD ASS52 | HH ASS52R |
| PA ASS102 | PB ASS102R |
| PD ASS183 | PE ASS183R |
| PF ASS103 | PG ASS103R |
| PH ASS104 | PN ASS104R |
| PR ASS105 | PT ASS105R |
| UU ASS94 | WW ASS94R |
| VV ASS51 | TT ASS51R |
| | XX ASS106R |

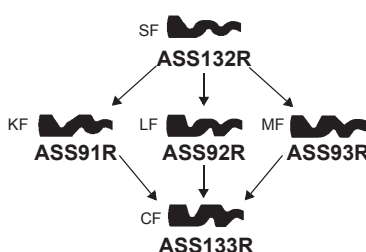
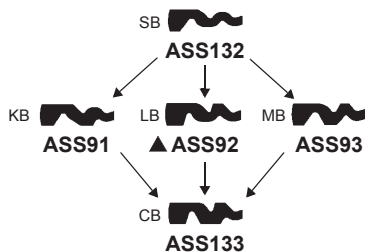
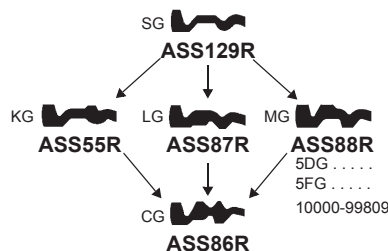
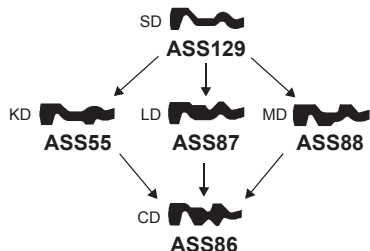
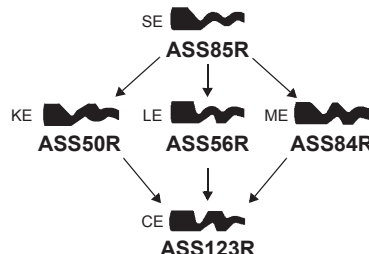
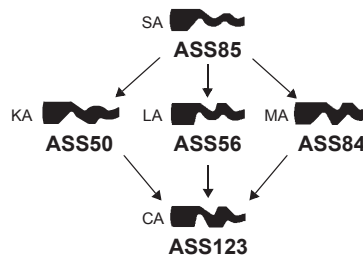

HABO

PER:
FOR:

ASTRA

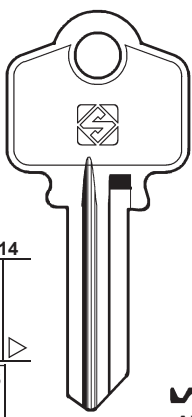

..... 12345678



..... 0-1-2-3-4-5-6-7
..... 1-2-3-4-5-6-7-8



..... 1-2-3-4-5-6-7-8

ATAY

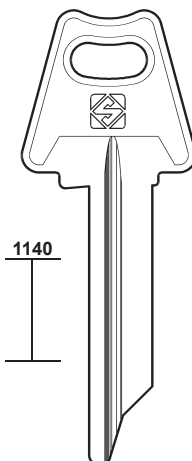

ATA1



ATA1R

AUDOLI

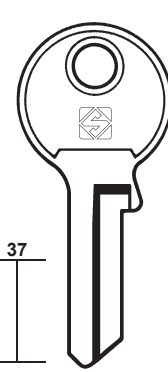

AUD1



26

PER / FOR

AUMON (ES)

AUSTRAL LOCK (AU)





AVA-CHUBB (SE)





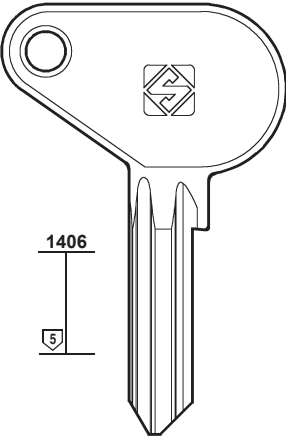
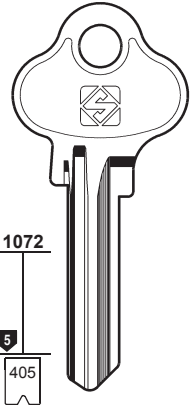
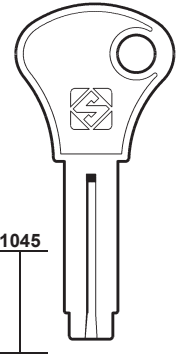

AVANGARD (RU)



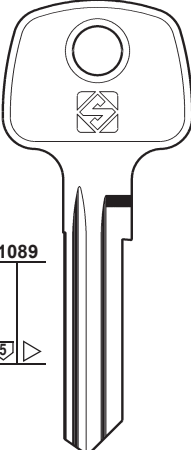
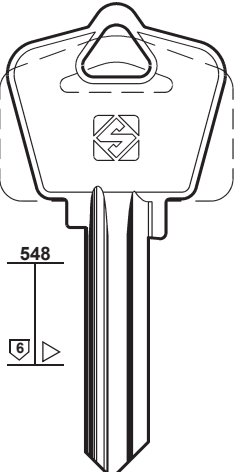
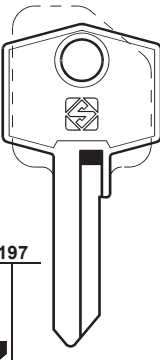



AVOCET (GB)
W.M.S.

AXA (NL)
+ BATON (31)

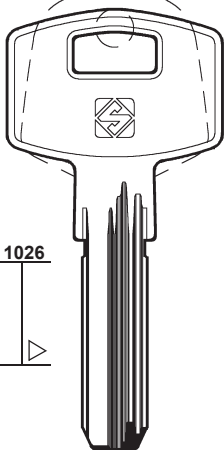
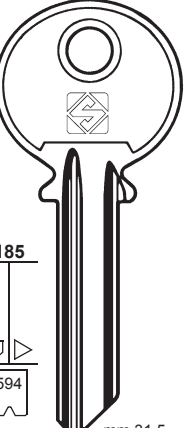
AZBE (ES)
+ TOK-WINKHAUS (187)

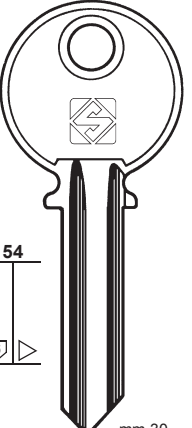
PER: FOR:	AUMON	AUSTRAL LOCK	AVA-CHUBB
	 1406 5	 1072 5 405	 1045
	 AUN1	 AUS1 0-1-2-3-4-5-6-7-8-9-A	 CHU7 

PER: FOR:	AVANGARD	AVOCET	AXA
	 1089 5	 548 6	 197 6
	 AV1	 AVC1 W.M.S.	 AX2
	 AV1R		
	 AV2		

PER: FOR:	AXA	AZBE
	 1026	 185 6 594 mm 31,5
	 AX12 	 54 6 mm 30
		 AZ1 X
		 AZ1R Y
		 AZ3
		 AZ3R

PER:
FOR:

AZBE

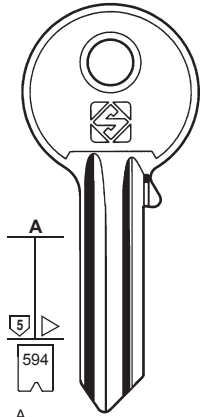

A mm 26,3
B
1-2-3-4-5-6-7-8



AZ2
A



AZ2R
B

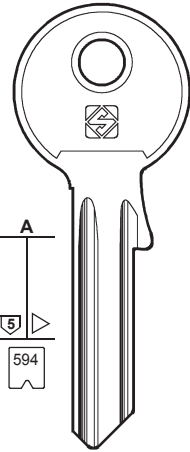

AZ2X

A 12345678

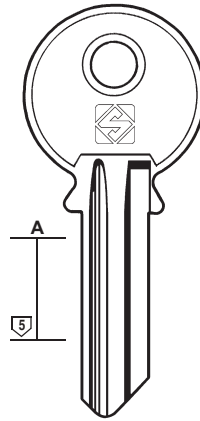

AZ4



27

PER / FOR

AZBE (ES)
CAVERS

+ TOK-WINKHAUS (187)

AZMA (FR)

VACHETTE (201)

PER:
FOR:

AZBE

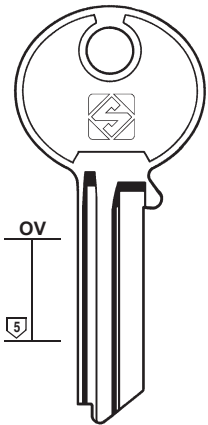

AZ5

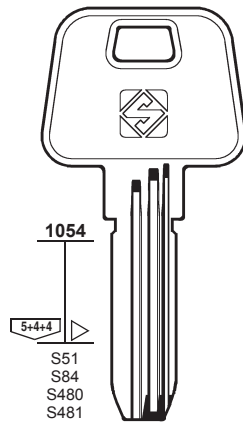

AZ6
HS-4



AZ6R



CAVERS

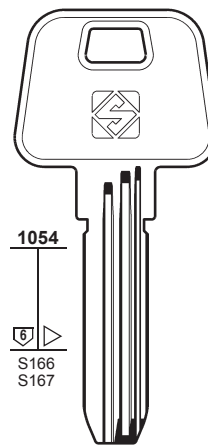

AZ7
HS-6



CAVERS

PER:
FOR:

AZBE

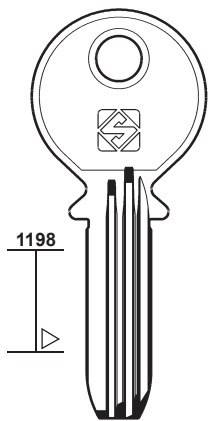

AZ8

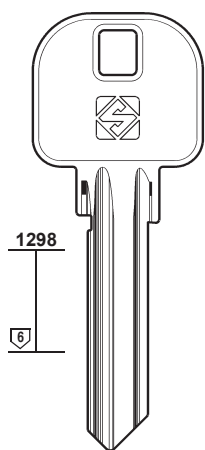

AZ9



AZ9R

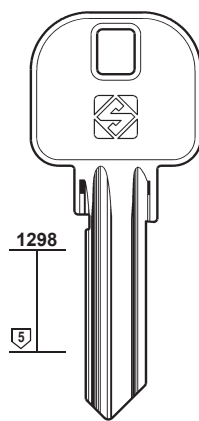

AZ10



AZ10R

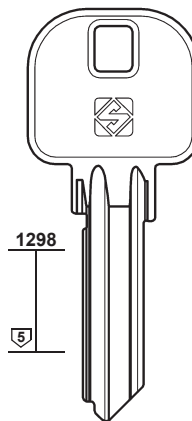

AZ11



28

PER / FOR

BAAL (CH)
VÖGEL

BAB (DE)
CORONA
ESS
+ CORONA (63)

PER:
FOR:

BAAL

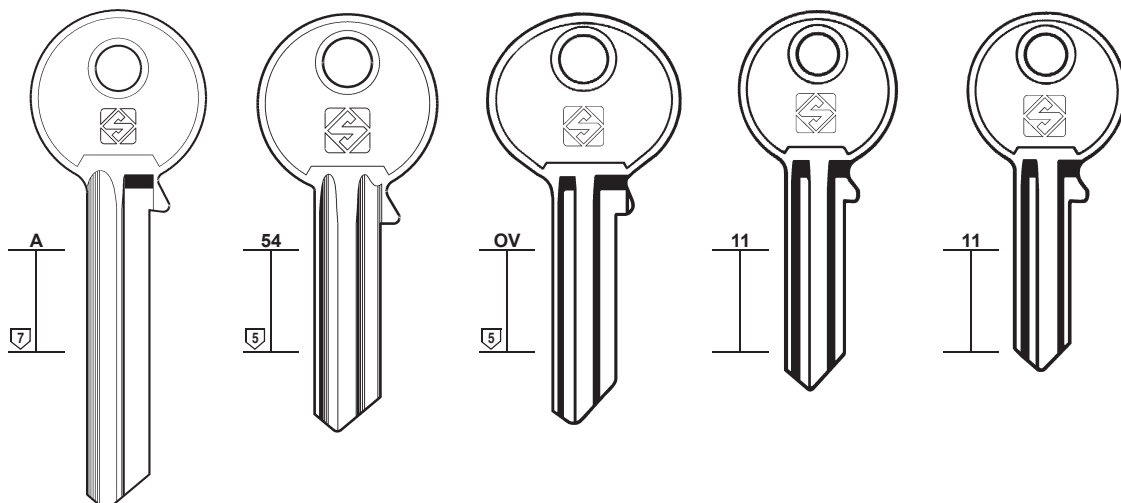

BAL7

BAL5

BAL1 BAL1R

BAL2

BAL3

VÖGEL

PER:
FOR:

BAAL

BAB

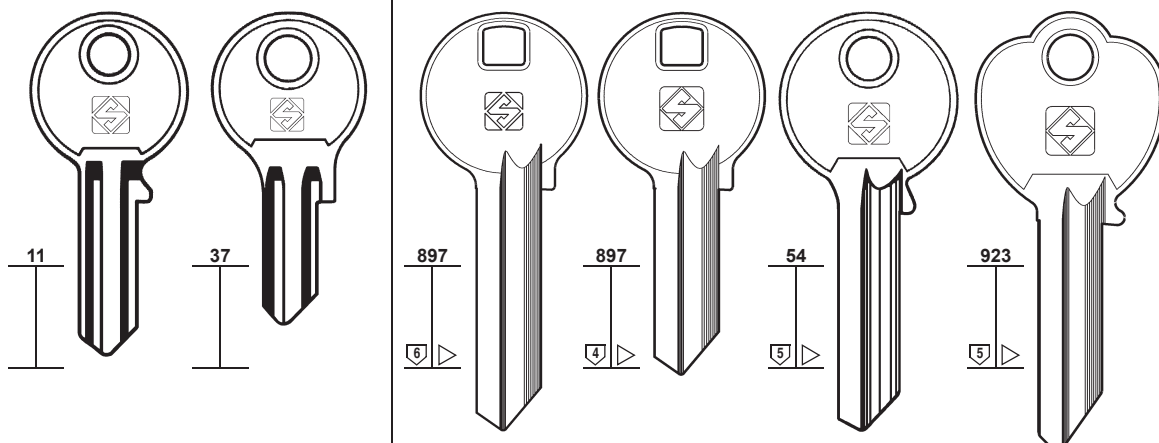

BAL4

BAL6

BAB6R

BAB4R

BAB7R

BAB5R

BAB2R

BAB18R

ESS

PER:
FOR:

BAB

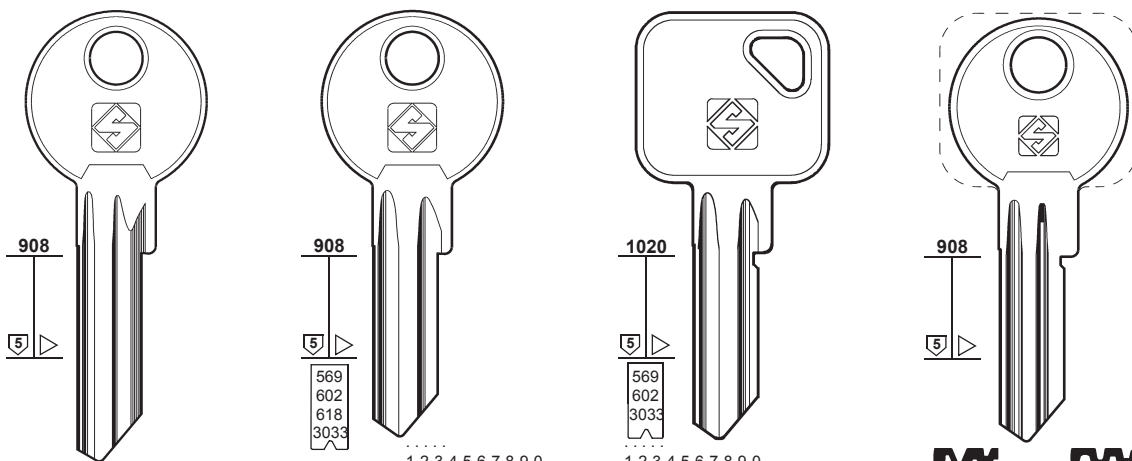

BAB14

BAB13

BAB13R

BAB25

BAB25R

BAB27

BAB29

BAB28R

ZEISS-IKON

CORONA - ZEISS-IKON

Copyright by Silca S.p.A. 2018 - All Rights Reserved

PER:
FOR:

BAB

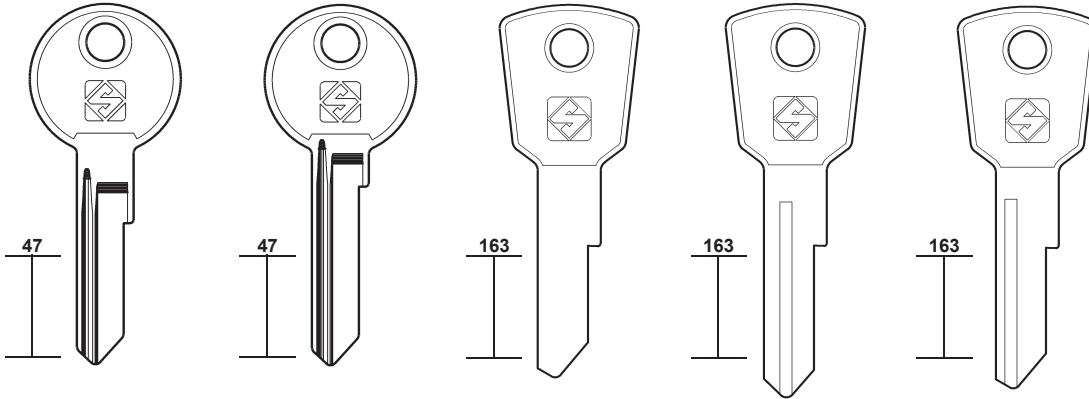

BAB15

BAB16

BAB19

BAB20

BAB21-3
 BAB21-5

BAB21-4

HALLE

HALLE

HALLE



29

PER / FOR

BAB (DE)
HALLE
+ CORONA (63)

PER:
FOR:

BAB

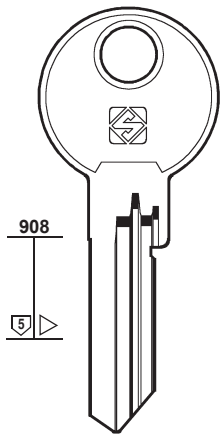

BAB26R-1
7

BAB26R-2
1

BAB26R-3
4

BAB26R-4
12

BAB26R-5
3

BAB26R-6
6

BAB26R-7

BAB26R-8

BAB26R-9

BAB26R-10

BAB26R-11

BAB26R-12

BAB26R-13

BAB26R-14

BAB26R-15

BAB26R-16

BAB26R-17

BAB26R-18

BAB26R-19

BAB26R-20

BAB26R-21

BAB26R-22

BAB26R-23

PER:
FOR:

BAB

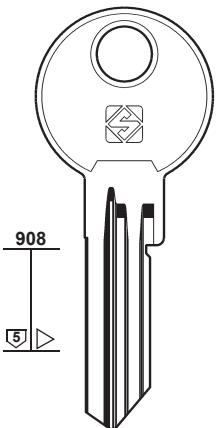

BAB30R-1

BAB30R-3

BAB30R-10

BAB30R-2

BAB30R-4

BAB30R-11

BAB30R-5

BAB30R-6

BAB30R-7

BAB30R-8

BAB30R-9

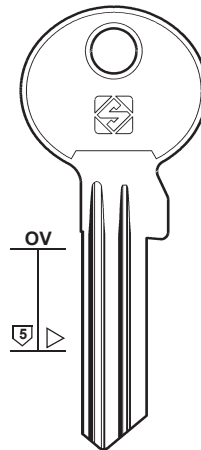

BAB31
N26

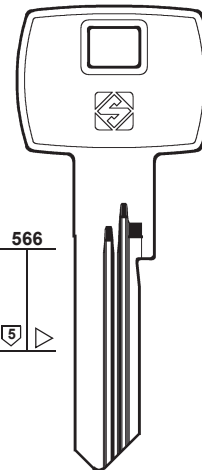

BAB36R



30

PER / FOR

BABY CLIP (FR)
EFSA
ETF

BAGEM (ES)
ABC (4)

BALDWIN (US)
SCHLAGE (166)

BALING LOCKS (CN)
T-KEY

BALLY (IT)
TAMPALINI (179)
ZANI (220)

BANE SEKULIĆ (RS)
BSS (40)

BANHAM (GB)
SIDLEEN (169)

BANKA (IT)
GIUSSANI (96)

BAODEAN (CN)
CINA (54)

BAODELI (CN)

BARAS (GR)

BARGMAN (US)
ILCO (106)

BARRO (DE)
DOM (68)

BASI (DE)
+ ABUS (8)
+ BUGA (40)
+ CISA (58)
+ EURO-LOCKS (79)
+ L & F (129)
+ SATURN (165)

PER: FOR:	BABY CLIP	BALING LOCKS	BANHAM	BAODEAN
	 BC1 BC1R	 BNL1R	 THIN BM1 THIK BM2	 BAE1
	EFSA - ETF	T-KEY		

PER: FOR:	BAODEAN		BAODELI
	 BAE2R	 BAE3	 BAD1 BAD1R

PER: FOR:	BARAS	BASI			
	 BAR1 BAR1R	 BAI2	 BAI3	 BAI4R	 BAI5R
				mm 40	mm 50

PER:
FOR:

BASI

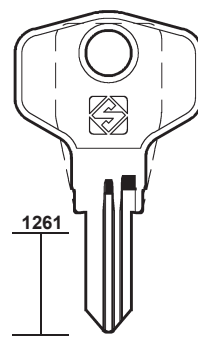
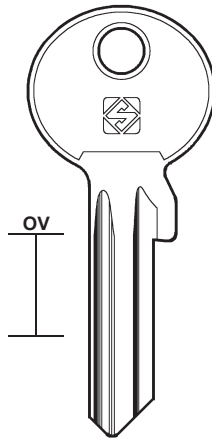
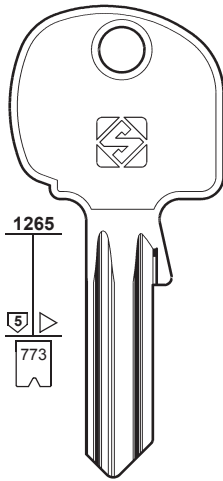
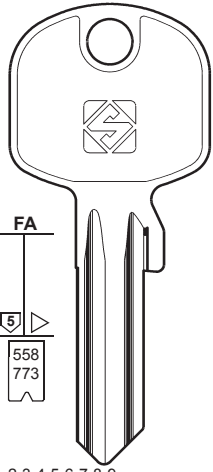

..... 1-2-3-4-5-6-7-8-9
..... 1-2-3-4-5-6-7-8-9-0
..... 800001-803640

..... 1-2-3-4-5-6-7-8-9-0
..... 800001-803640



CIC



31

PER / FOR

BASI (DE)

- CIC
- + ABUS (8)
- + BUGA (40)
- + CISA (58)
- + EURO-LOCKS (79)
- + L & F (129)
- + SATURN (165)

BASCO (US)

BIZERBA
ELMO

BASSI (IT)

- + GEVY (95)

BASTA (IE)

BASTA (DK)
EURO LOCKS

BATON (TW)

AXA

PER:
FOR:

BASCO

BASSI

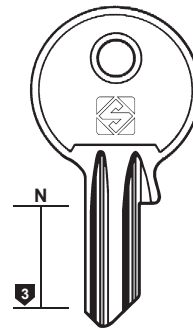
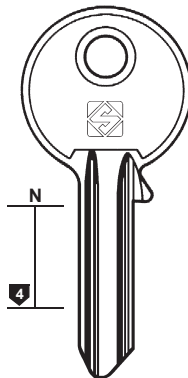
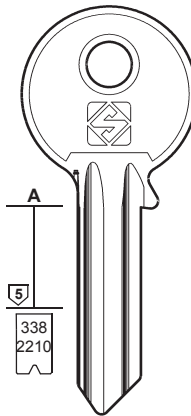
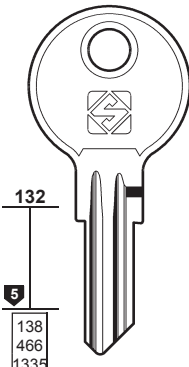
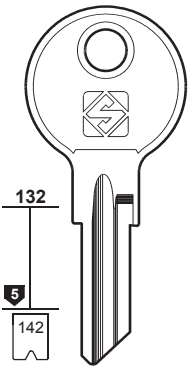

C 1701-1950
C 1951-2200
C 250-499
C 500-699

AN 1-500
HC 0-499
LL 1-326
LL 1-200
LL 1-200
DD 1-250
GC 101-150
CH 751-1178
RC 501-750

..... 0-1-2-3-4-5
..... 1-2-3-4-5

ELMO

BIZERBA - ELMO

PER:
FOR:

BASTA (IE)

BASTA (DK)

BATON

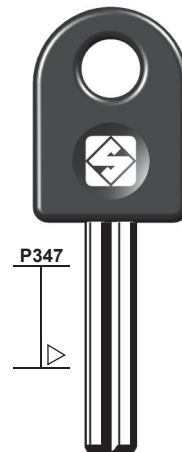
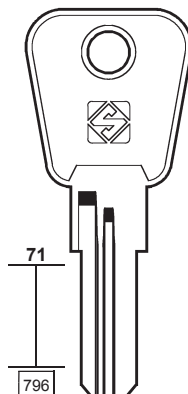
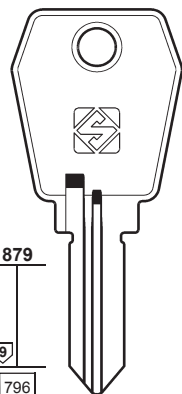
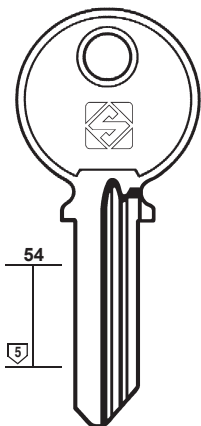

M 1-1000
V 1-1000
W 1-1000
C 1-1000

C 1-1000

EURO LOCKS



AXA





32

PER / FOR

BATON (TW)

BATU (ES)

👁️ CISA (57)

👁️ IFAM (106)

BECCARINI (IT)

BEDI (FR)

👁️ YETI (218-219)

BELL (TW)

+ 👁️ YETI (218-219)

BELLEVILLE (USA)

BENCO (NL)

👁️ YETI (219)

BENDIX (US)

👁️ YALE (213)

BERAM (TW)

👁️ VIRO (206)

BERETTA (IT)

👁️ FASEM (86)

BERRY (DE)

👁️ BKS (34)

👁️ CES (47)

BERTO (CH)

PER: BATON

FOR:

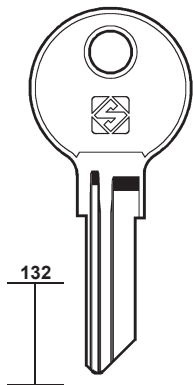

BAT2

PER: BECCARINI

FOR:

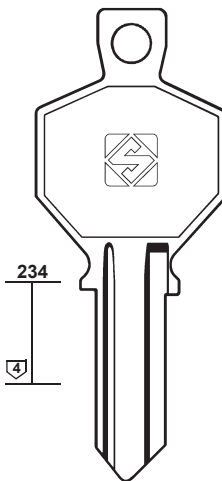

BN1

BN1R

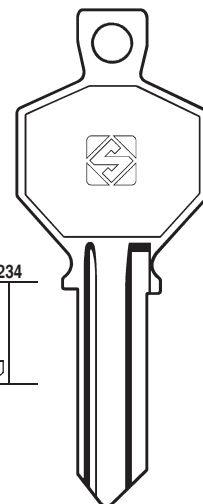

BN2

BN2R

PER: BELL

FOR:

BELL

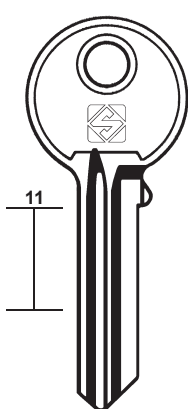

BLL1

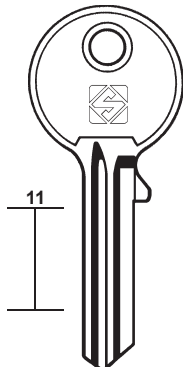

BLL2

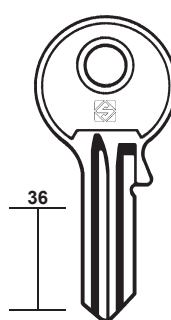

BLL3

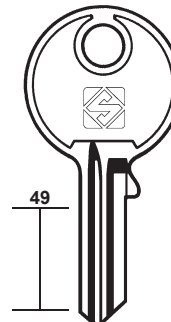

BLL4



BLL5



PER: BELLEVILLE

FOR:

BELLEVILLE

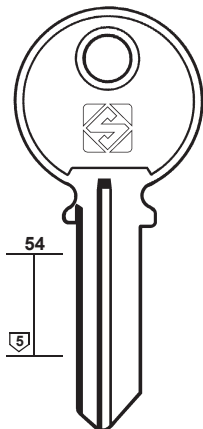

BLV1R

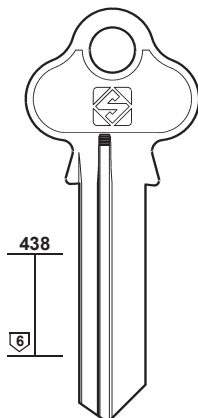

BLV2R

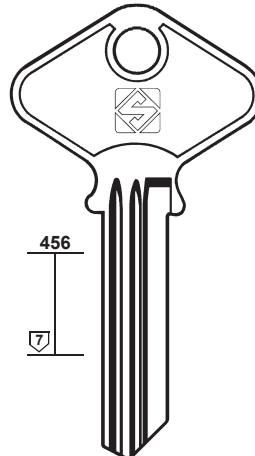

BLV3

PER: BERTO

FOR:

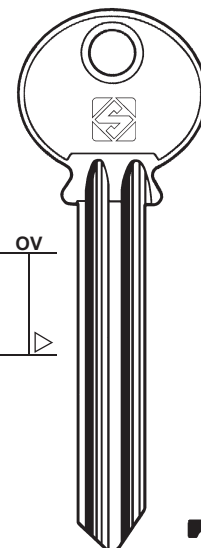

BRT1

PER:
FOR: **BERTO**

BEST



33

PER / FOR

BERTO (CH)

BERTOLOTTI (IT)

TICINO (182)

BEST (US)

FALCON

BETA (IT)

PICARD

+ CORNI (62)

BEY (TR)

BIB (IT)

MERONI (136)

BIBERING (DE)

TAS (180)

BIELLE (IT)

FASEM
OMIV
P.C.

BIFFAR (DE)

TOK-WINKHAUS (187)

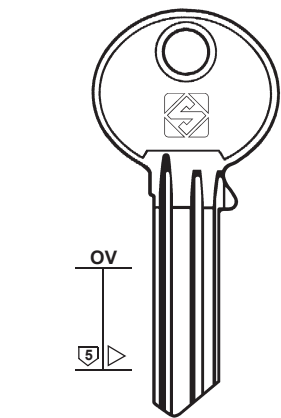

BRT2



BRT3



BRT4

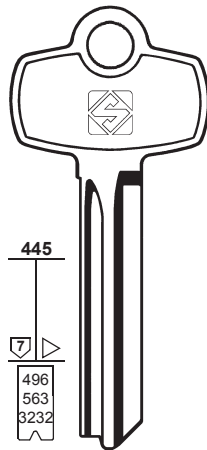

..... 0-1-2-3-4-5-7-8-9
..... 0-1-2-3-4-5
..... 0-1-2-3-4-5-6-7-8-9



BES1



BES2



BES3



BES4



BES5



BES6



BES7



BES8



BES9



BES10



BES11



BES12



BES16



BES17



BES18

FALCON

PER:
FOR: **BETA**

BETA

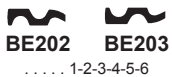
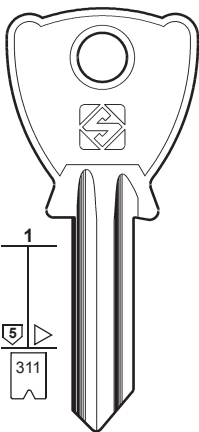

BE202 BE203

..... 1-2-3-4-5-6

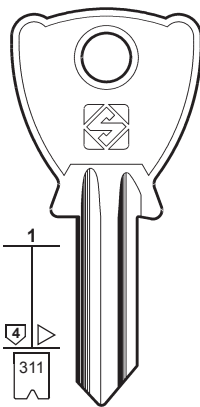

BE200 BE201

..... 1-2-3-4-5-6

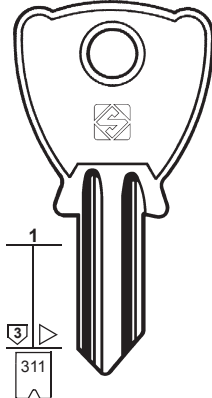

BE4R

..... 1-2-3-4-5-6

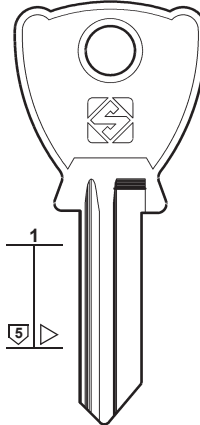

BE3

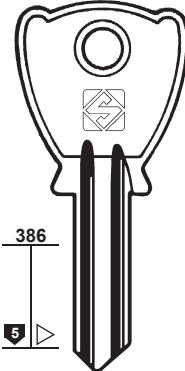

BE1 BE1R

PICARD



PER:
FOR: **BEY**

BIELLE

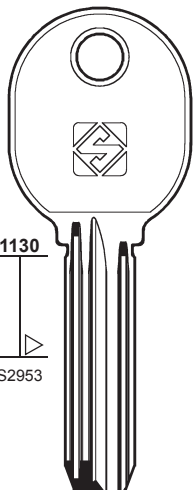

BEY1R

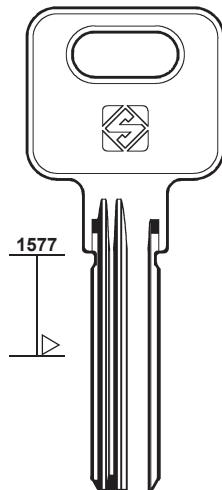

BEY2R

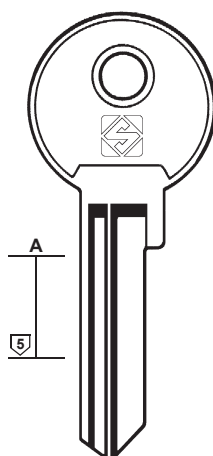

BI110

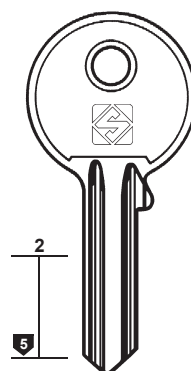

BI062



BI063

FASEM - OMIV - P.C.



34

PER / FOR

BILMA (ES)

BIGLA (CH)

BIRD (HK)

YALE (212)

BIZERBA (HK)

BASCO (31)

BKS (DE)

BERRY
DAMM
GEBÄ
HÄFELE
HÖHRMANN
YALE

+ LITTO (125)

+ YALE (212-213)

PER:
FOR:

BILMA

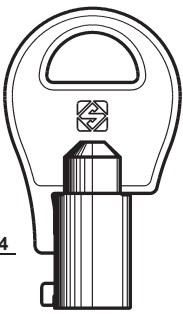

1314

S344 1-2-3-4-5-6
S1290 X-1-3-4-5-6

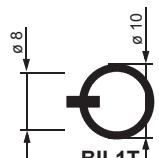

ø 8
ø 10
BIL1T

PER:
FOR:

BIGLA

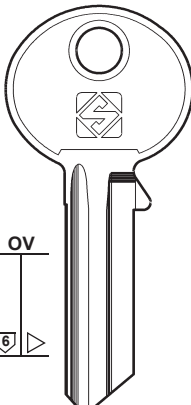

OV

5



BG1

PER:
FOR:

BKS

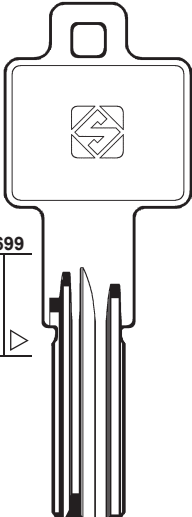

1699



OV

5
2933



BK61



BK1X
PZ

1234567890ABCDEFGHIJL



BK49R



BK48R



BK27



BK23R



BK22R



BK21R



BK13
0211

PER:
FOR:

BKS

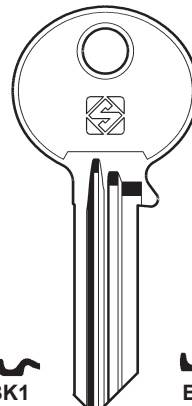

OV

5

344
614
534
2933
2936

PZ

BK1

..... 01234567
..... 0123456789
..... 1234567890ABCDEFGHIJL
..... 050001-80453



BK1R
38



BK2R



YA9



BK3-1



BK3-7



BK7R-1



BK7R-6



BK3-2



BK3-8



BK7R-2



BK7R-7



BK3-3



BK3-9



BK7R-3



BK7R-8



BK3-4



BK3-10



BK7R-4



BK7R-9



BK3-5



BK3-11



BK7R-5



BK7R-10



BK3-6



BK3-12

Serie O
BERRY - DAMM - GEBÄ - HÖHRMANN - YALE

PER:
FOR:

BKS

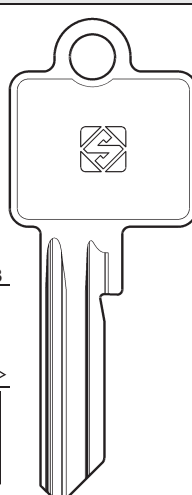

1423

5

344
614
534
2933
2936

PZ

BK15

..... 01234567
..... 0123456789
..... 1234567890ABCDEFGHIJL
..... 050001-80453



BK60



BK18
0212



BK17
0213



BK16
0214

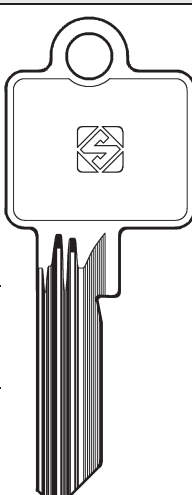

1423

5



BK20
07



BK28
17



BK29
19



BK30
01



BK31
02



BK32
09



BK34
14



BK36
04



BK38
06



BK37
05



BK52
10



BK53
16



BK99-03
03



BK99-08
08



BK100

HÄFELE

Serie 42

PER:
FOR:

BKS

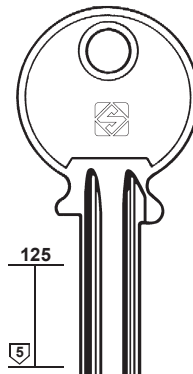
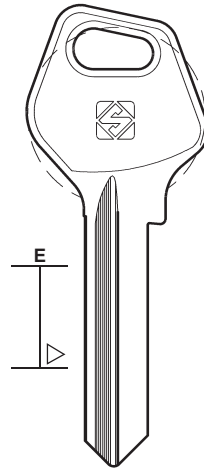
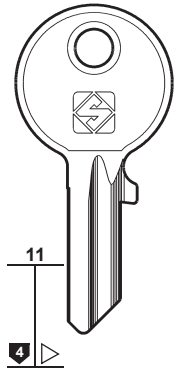
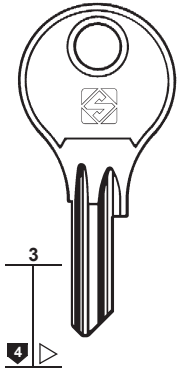

METEOR - YALE



35

PER / FOR

BKS (DE)
METEOR
YALE
+ LITTO (125)
+ YALE (212-213)

PER:
FOR:

BKS

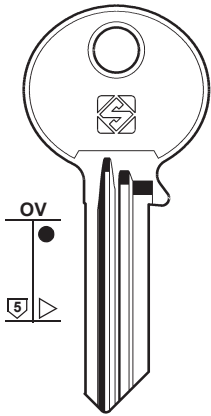

Serie 1000



PER:
FOR:

BKS

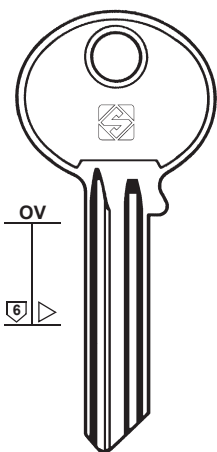

Serie 1000





36

PER / FOR

BKS (DE)

+ LITTO (125)

+ YALE (212-213)

BLASER (CH)

VADETO

WILKA

BLINKY (CN)

BLOCKSHAFT (IT)

BLOCTOUT (FR)

+ BRICARD (39)

BLOCUS (FR)

+ PREFER (157)

+ RONIS (161)

BMB (DE)

BODA (FI)

+ CES (47-49-50)

PER:
FOR:

BKS

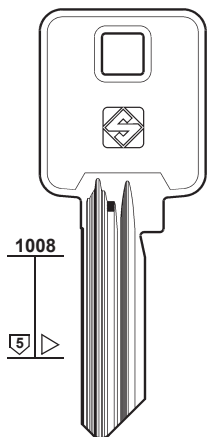

1008



BK10-00
Serie 2000

BK10-01

BK10-07

BK10-13

BK10-19

BK10-02

BK10-08

BK10-14

BK10-20

BK10-03

BK10-09

BK10-15

BK10-21

BK10-04

BK10-10

BK10-16

BK10-22

BK10-05

BK10-11

BK10-17

BK10-23

BK10-06

BK10-12

BK10-18

BK10-30

PER:
FOR:

BLASER

BLINKY

BLOCKSHAFT

BLOCUS

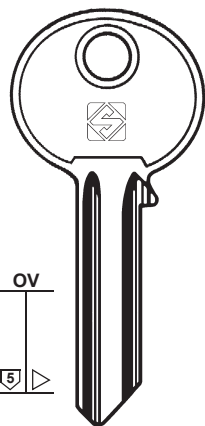

OV



BLA3

BLA1

BLA2
WILKA

VADETO

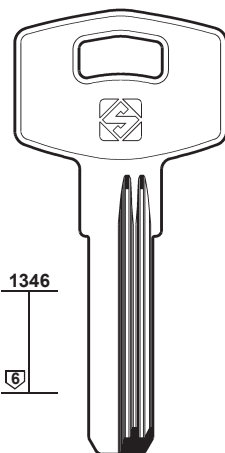

1346



BNK1

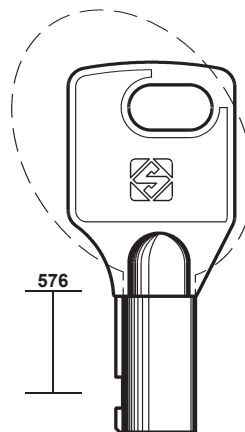

576

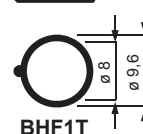

BHF1T

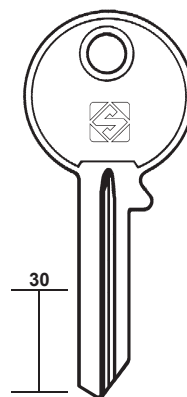

30

BL1

BL1R

PER:
FOR:

BMB

BODA

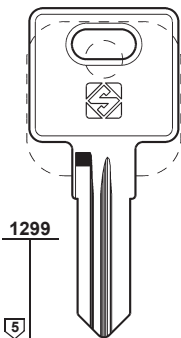

1299



BMB1

BMB1R

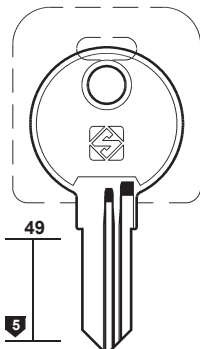

49



BMB2

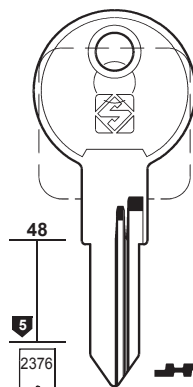

48



2376

BMB3
A... 1-200

BMB5
A... 401-600

BMB3R
A... 1-200

BMB4
A... 201-400

BMB4R
... 1-2-3

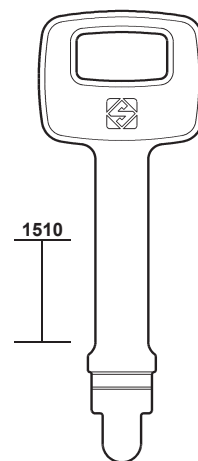

1510

BDA10

PER:
FOR: **BOMMER**

BOMORO

BÖRKEY



37

PER / FOR

BOMMER (US)

BOMORO (DE)
HUWIL
LAPORTE
PRESTA

BÖRKEY (DE)
+ KABA (113)

BOSS (IT)
MARLIN

BOTT (FR)
CES (48)

BRABANTIA (ES)
CLAUSOR (59)
ME-FA (135)

BRASIL (BR)

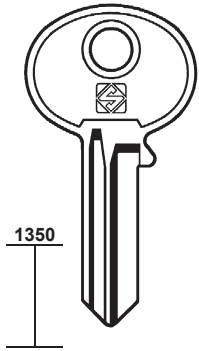

BOR1 BOR1R

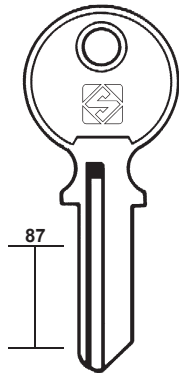

BO2 BO2R

LAPORTE - PRESTA

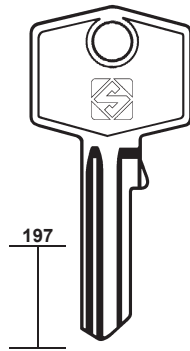

BO6 BO6R

HUWIL

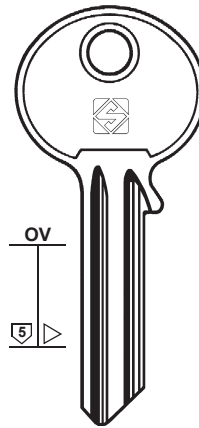

BY1

PER:
FOR: **BOSS**

BRASIL

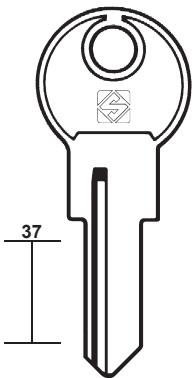

BOS1



mm 60

MARLIN

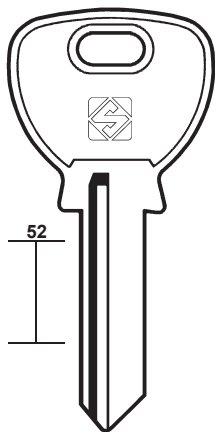

BOS3



mm 70-90

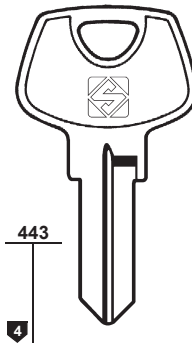

BRA1R

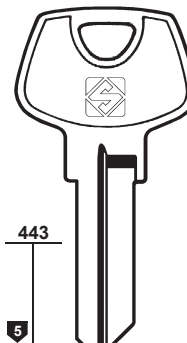

BRA2R

BRA3R

PER:
FOR: **BRASIL**

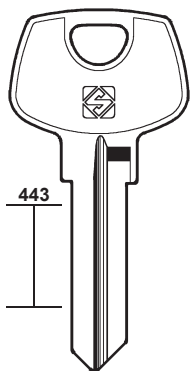

BRA16R

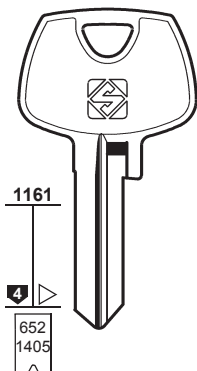

BRA7R

..... 1-2-3-4-5
..... 1-2-3-4-5-6

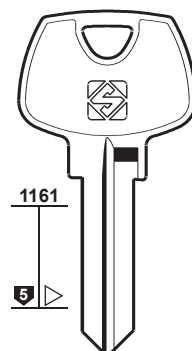

BRA9R

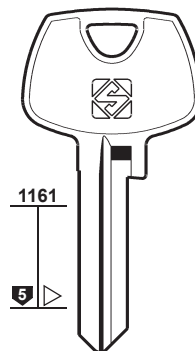

BRA10R



38

PER / FOR

BRASIL (BR)

BRETER (IT)
GIUSSANI
ZADI

+ GIUSSANI (96)

PER:
FOR:

BRASIL

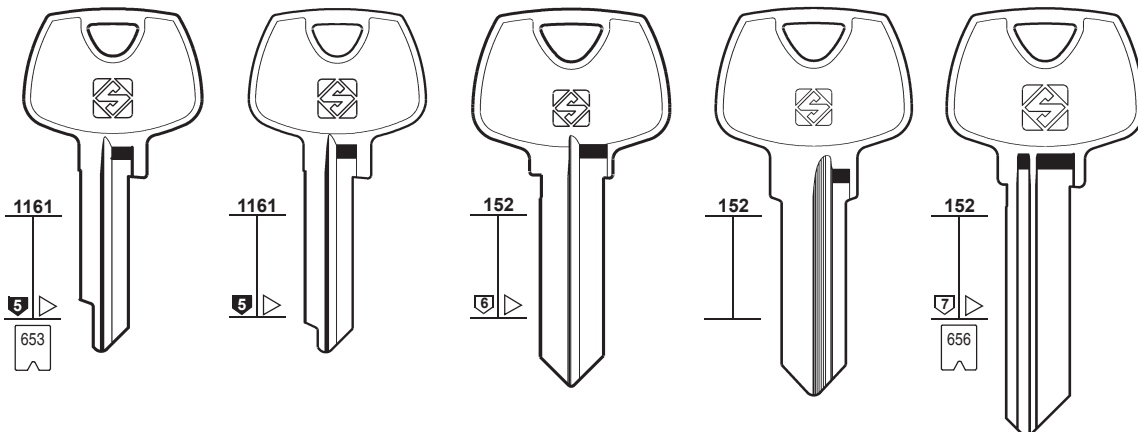

BRA6R

..... 1-2-3-4-5-6

BRA11R

BRA8R

BRA15R

BRA5

..... 1-2-3-4-5-6-7

PER:
FOR:

BRETER

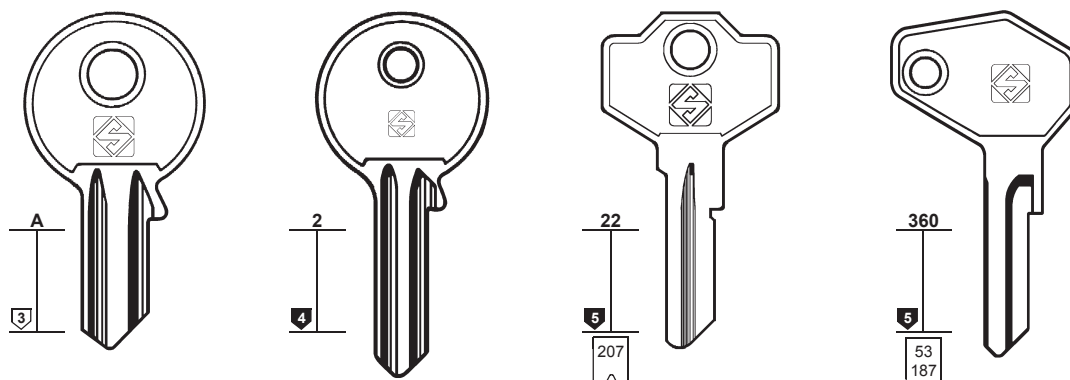

BR1

GS3 **GS3R**

SM1

G... 0-480
..... 3001-3480
G... 3001-3480
..... 9001-9741
G... 9001-9741

ZD7

..... 0001-1625
E... 1-500
E... 501-710
..... 9001-9500



PER:
FOR:

BRETER

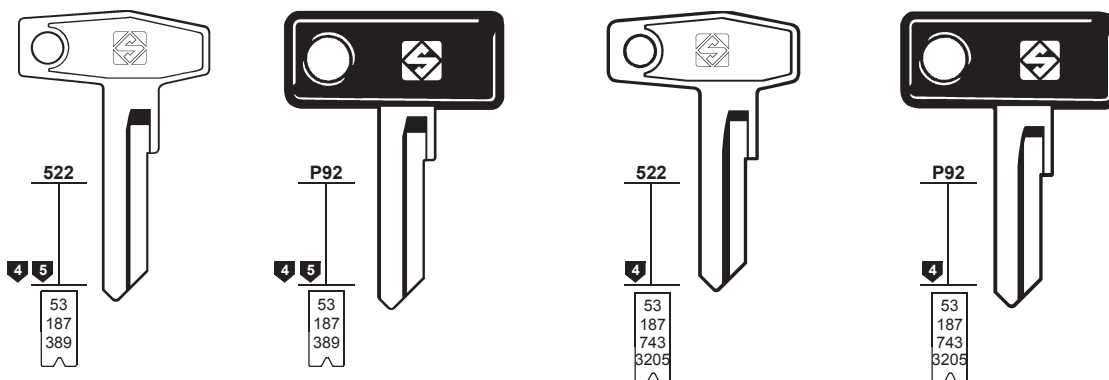

ZD9

..... 1-1625
E... 500
E... 501-710
..... 9001-9500
..... 5001-6278

ZD9P

..... 1-1625
E... 500
E... 501-710
..... 9001-9500
..... 5001-6278

ZD11

..... 1-1625
E... 1-500
..... 5001-6278
E... 501-710
..... 1234
H... 100-341

ZD11P

..... 1-1625
E... 1-500
..... 5001-6278
E... 501-710
..... 1234
H... 100-341



ZADI



ZADI



PER:
FOR:

BRICARD



39

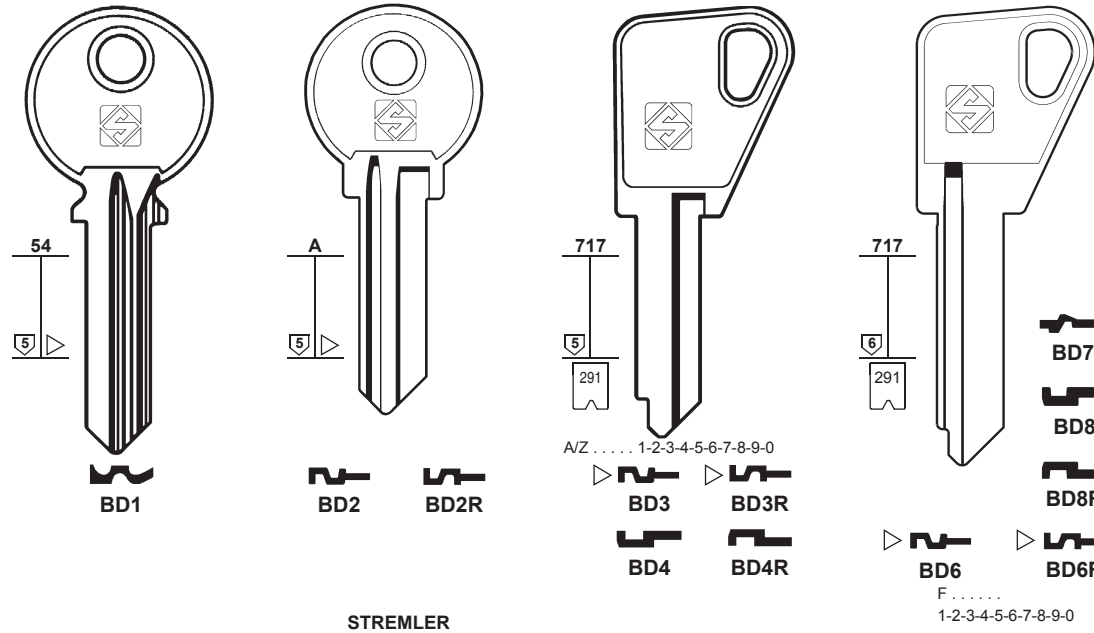

PER / FOR

- BRICARD (FR)**
 ABUS
 BLOCTOUT
 INLOC
 STREMLER
 + ABUS (7)
 + CISA (55-56)
 + G.R. (99)
 + KWIKSET (119)
 + LOB (126)
 + SARGENT (165)

PER:
FOR:

BRICARD

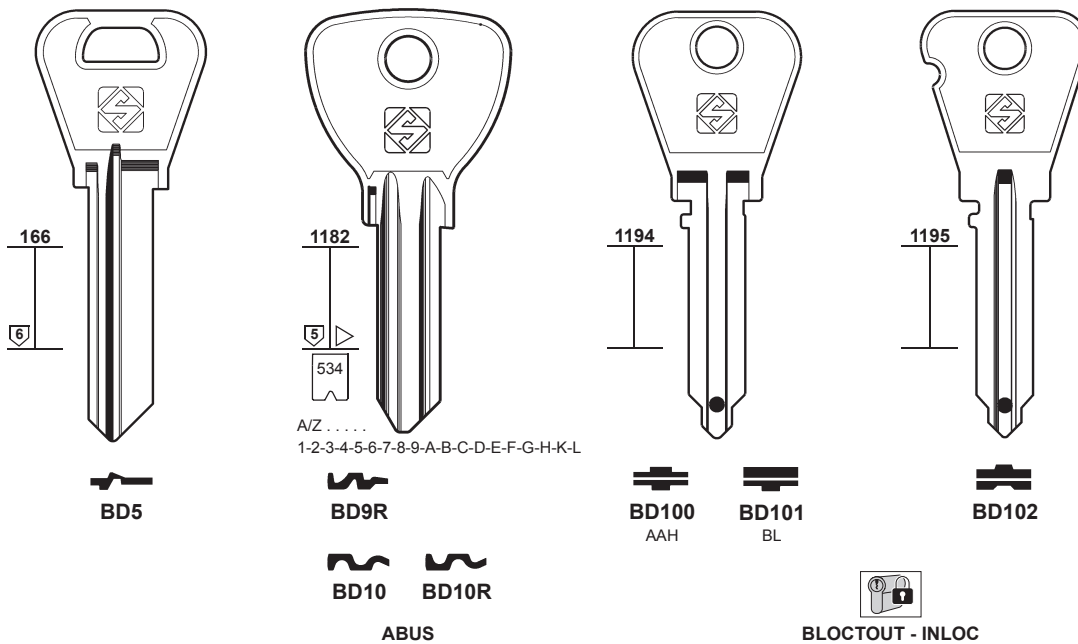

PER:
FOR:

BRICARD

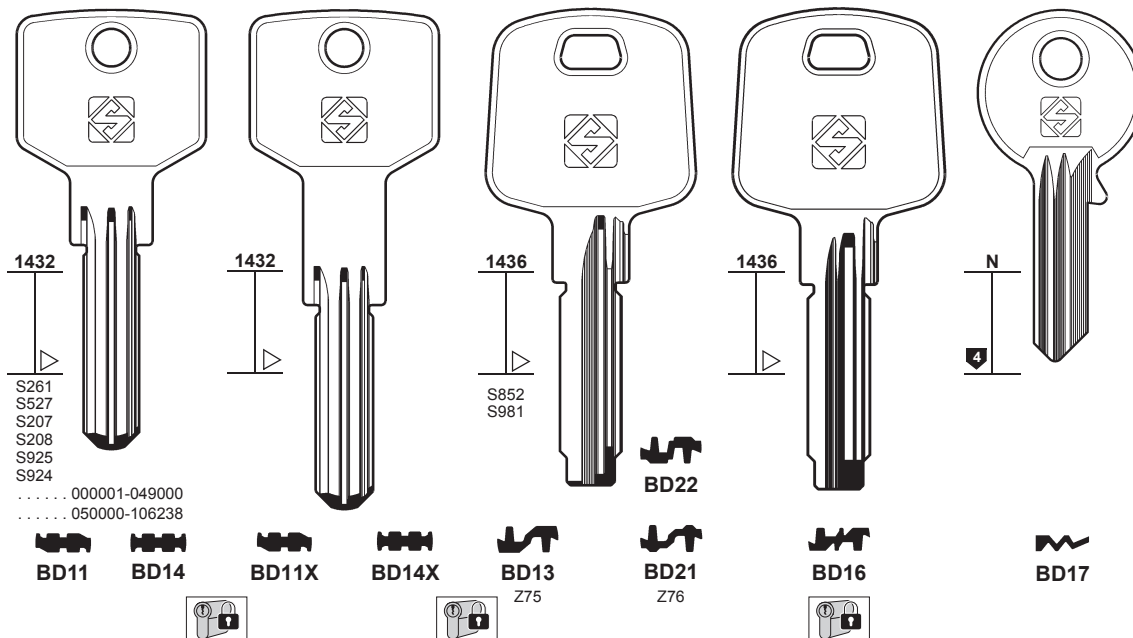



40

PER / FOR

BRISANT (GB)
HUGO

BRUMME (DE)
FANA
FTH
+ ZEISS-IKON
(220-221)

BSS (RS)
BANE SEKULIĆ
+ URBIS (197)

BTV (ES)
AGA (11)
DOM (68)
STS (177)

BUFFO (GR)
ABUS (7-9)

BUG (DE)
CORONA (63)

BUGA (FR)
BASI
CITY
IFAM

PER:
FOR:

BRISANT

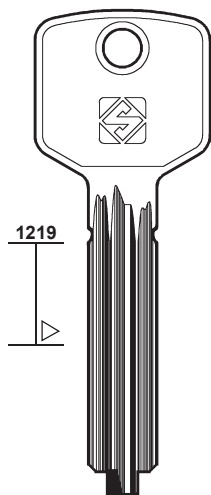

1219



BRS1R

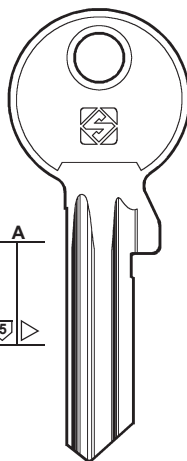

A

5



BRS3R



BRS2



HUGO

BRUMME

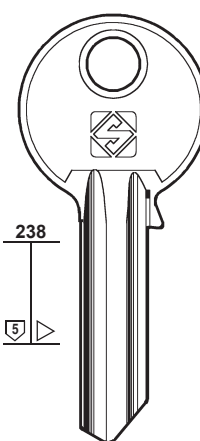

238

5



BRM1



BRM1R

FANA - FTH

PER:
FOR:

BSS

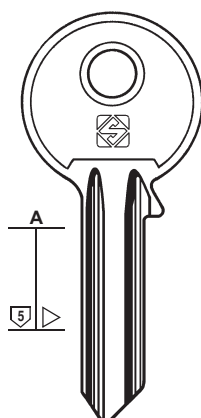

A

5



BS1

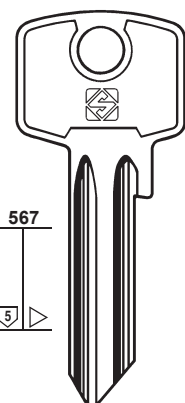

567

5



BS7

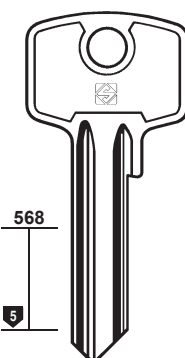

568

5



BS7R



BS3



BS4R

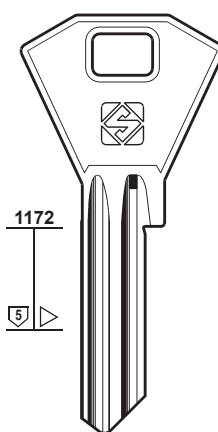

1172

5



BS5



BS5R

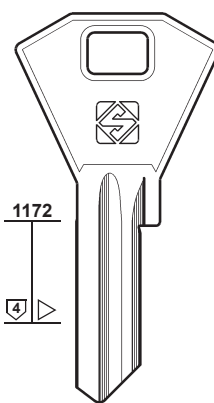

1172

4



BS6R

BANE SEKULIĆ

PER:
FOR:

BUGA

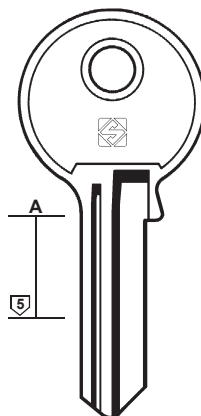

A

5



CS33



CS33R

BASI



mm 50-60

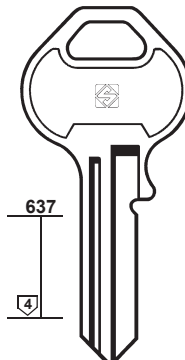

637

4



CS32



CS32R

BASI - CITY



mm 40

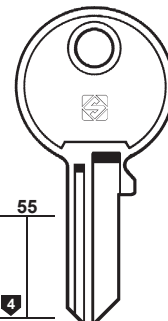

55

4



CS26



CS26R

CITY



mm 30



215

3



CS23



CS23R

BASI - IFAM



mm 20

PER:
FOR:

BULAT

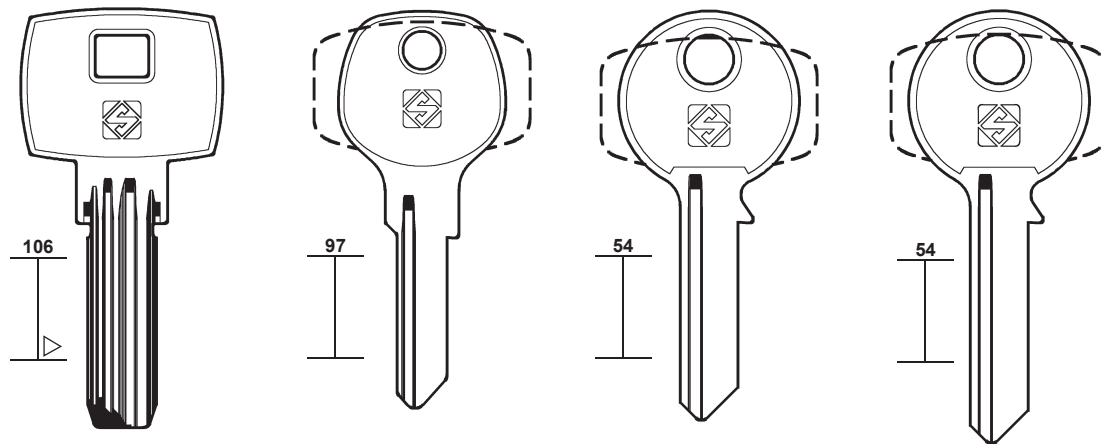

BUT1R



BUT2R

BUT3R

BUT4R



41

PER / FOR

BULAT (CN)

BULLDOG (GB)

BULLOCK (IT)

ZADI (220)

BURAM (ex YU)

BURG (DE)
MELSMETALL

- + ABUS (8)
- + HOPPE (103)
- + MELSMETALL (136)
- + OJMAR (147)
- + RONIS (162)
- + VIRO (206)
- + ZEISS-IKON (221)

PER:
FOR:

BULLDOG

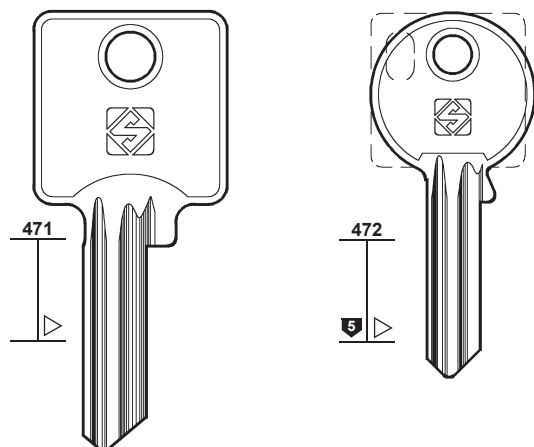

BLG1

BLG2

BURAM

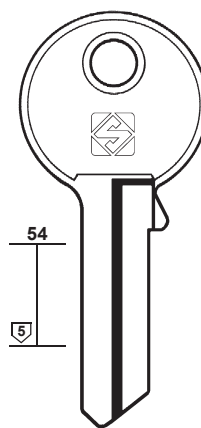

BU1

BU1R

PER:
FOR:

BURG

BUR1

19
20
21
23
27
29
31
33
49
769
799
0-1-2-3-4-5-6

BUR8

19
20
22
24
28
30
32
34
799
0-1-2-3-4-5-6

BUR2

11
12
13
14
15
16
17
18
25
30
35
36
37
38
40
41
42
43
44
45
47
50
51
52
239
319
339
359
379
239
389
399
409
429
449
509
529
549
569
589
608
609
629
649
659
689
709
729
749
789
809
819
829
(116/30)
0-1-2-3-4-5-6
0-1-2-3-4-5-6

BUR2R

11
12
26
46
309
329
349
369
389
419
439
459
519
539
559
579
599
619
639
669
679
699
719
739
759
839
245
293
0-1-2-3-4-5-6

BUR1R

19
20
22
24
28
30
32
34
799
0-1-2-3-4-5-6

BUR6

11
12
259
269
279
0-1-2-3-4-5-6

BUR7

mm 30-40
MELSMETALL



42

PER / FOR

BURG (DE)

- + ABUS (8)
- + HOPPE (103)
- + MELSMETALL (136)
- + OJMAR (147)
- + RONIS (162)
- + VIRO (206)
- + ZEISS-IKON (221)

PER:
FOR:

BURG

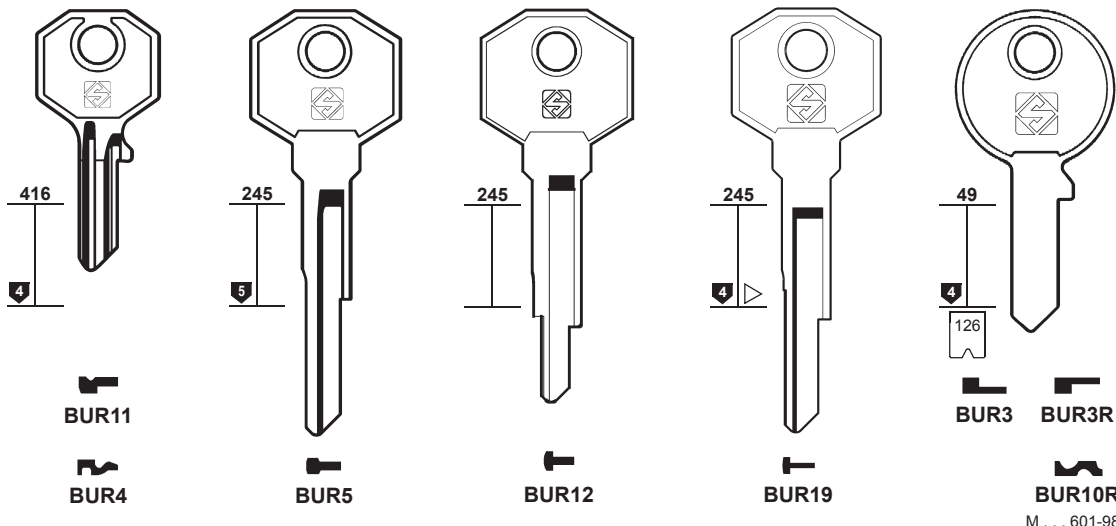

BUR11

BUR4

BUR5

BUR12

BUR19

BUR3

BUR3R

BUR10R

M... 601-983

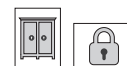

PER:
FOR:

BURG

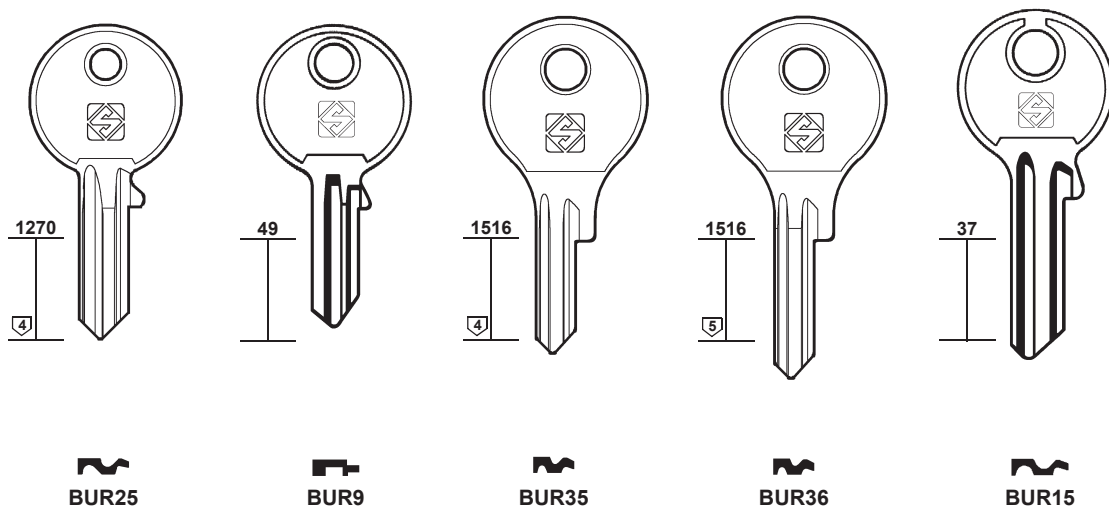

BUR25

BUR9

BUR35

BUR36

BUR15



PER:
FOR:

BURG

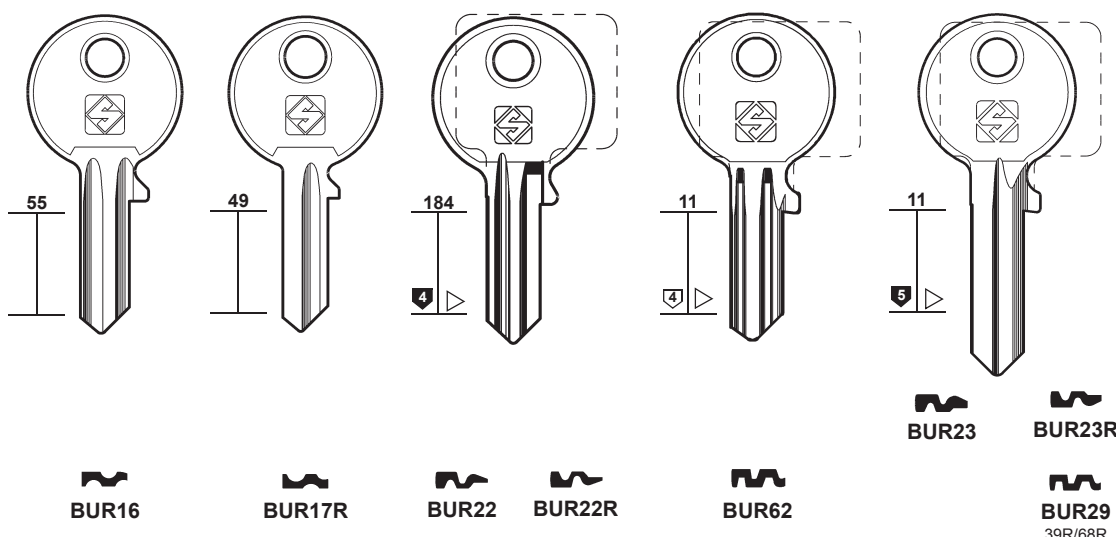

BUR16

BUR17R

BUR22

BUR22R

BUR62

BUR23

BUR23R

BUR29

39R/68R



mm 30-35



mm 40

PER:
FOR:

BURG

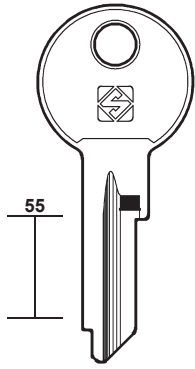

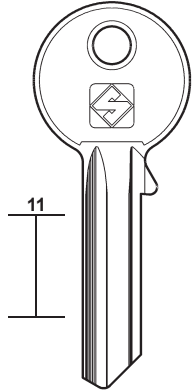

BUR60R



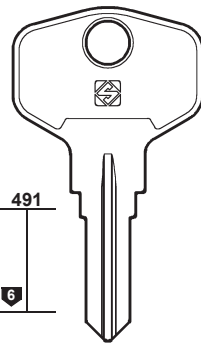

BUR18

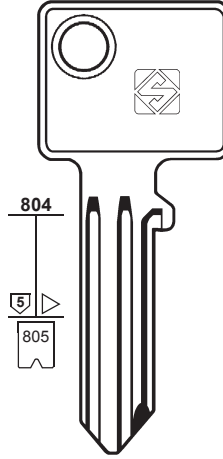

BUR61R











BUR13
..... (600/40) 123456
..... (600/50) 123456
..... (600/60) 123456



43

PER / FOR

- BURG** (DE)
HOPPE
OTTO
- +  ABUS (8)
 - +  HOPPE (103)
 - +  MELSMETALL (136)
 - +  OJMAR (147)
 - +  RONIS (162)
 - +  VIRO (206)
 - +  ZEISS-IKON (221)

PER:
FOR:

BURG

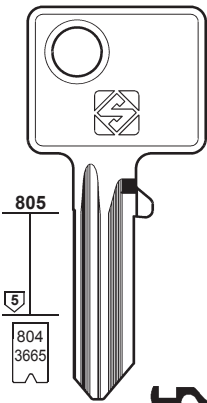



BUR14R

BUR21
..... (116/40)
..... (116/50)
..... (116/60)
..... 123456



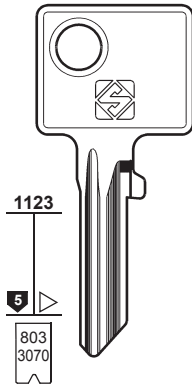

BUR21R



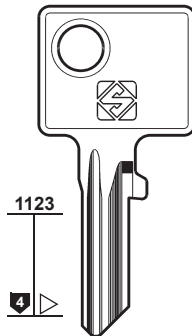

BUR20
..... (116/30)
0-1-2-3-4-5
..... 1-2-3-4-5-6

BUR20R

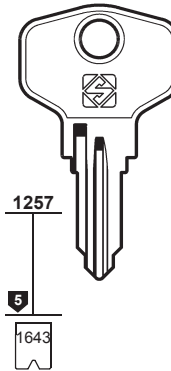

BUR26





BUR24R
2W ... 1-246

HOPPE - OTTO

PER:
FOR:

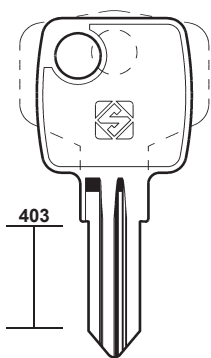
BURG



BUR28R
34W

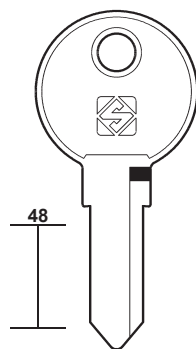

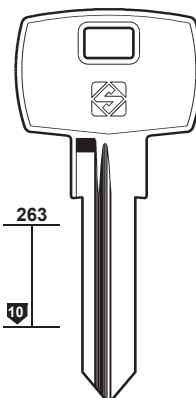

BUR31 **BUR31R**

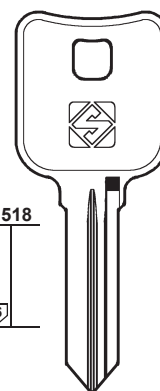

BUR32
26W

BUR34R



BUR38





44

PER / FOR

BURG (DE)

- + ABUS (8)
- + HOPPE (103)
- + MELSMETALL (136)
- + OJMAR (147)
- + RONIS (162)
- + VIRO (206)
- + ZEISS-IKON (221)

BUS (DE)
KROST

BUVA (DE)

- GERA
- KALE
- + PHAFFENHAIN (155)

BV (DE)

- + CAS-CISMA (45)
- + FASEM (86)

BWS (GB)

- + CORBIN (60)

CAB (IT)

- + CAS-CISMA (45)
- + SIMECA (170)
- + YALE (213)

CAF (IT)

CAM (FR)

- + ISEO (108)

PER:
FOR:

BURG

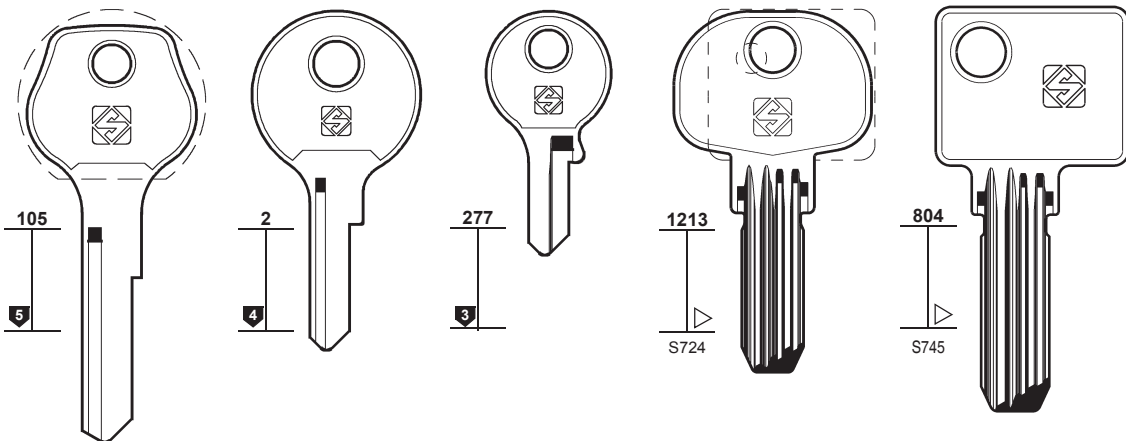

BUR57R
71R

BUR55R
77R

BUR56
405/20

BUR27
75W

BUR33
76W



PER:
FOR:

BUS

BUVA

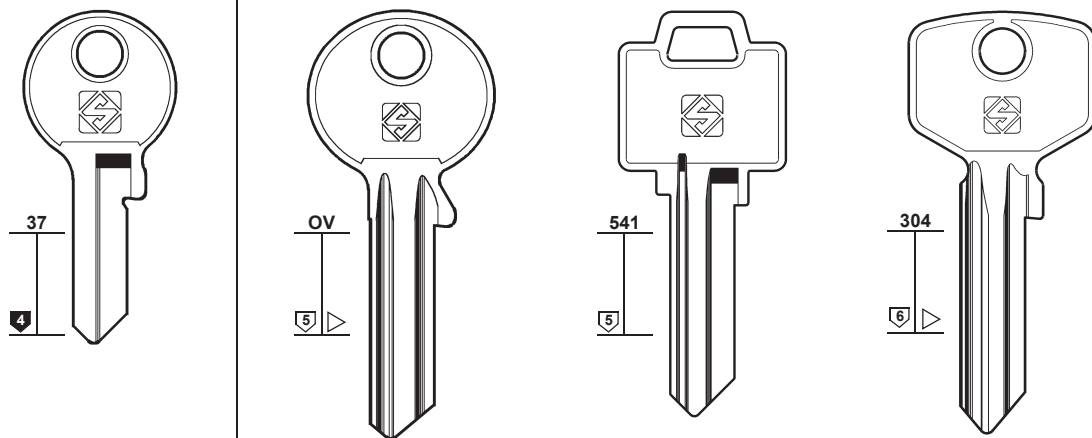

BUS1

BVA1

BVA1R

BVA3

BVA4

KROST

GERA - KALE

PER:
FOR:

CAB

CAF

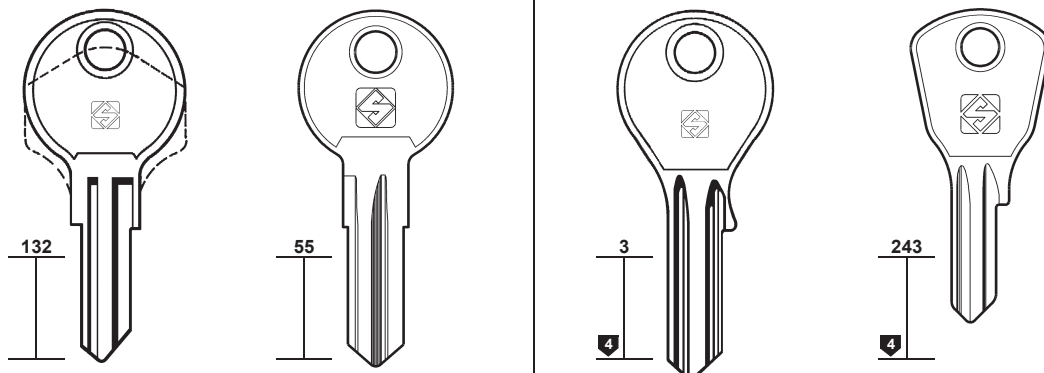

CAB1

CAB2R

CAF1

CAF1R

CAF2

CAF2R



PER:
FOR:

CANDAVEN CV

CARACAL

CARL F

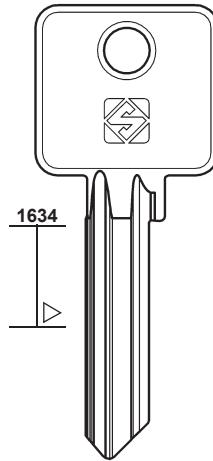
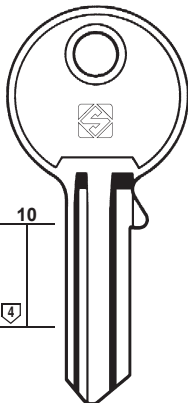
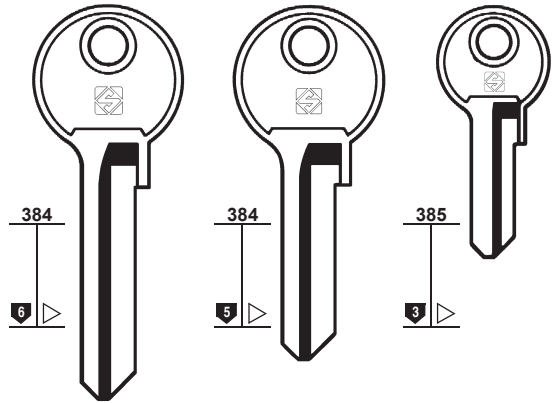

CV1



CV2



CV3



CAR1



CLF2



45

PER / FOR

CANDAVEN CV (VE)

CAP (FR)

- CITY (58)
- KVR (119)
- PREFER (157)
- VACHETTE (201)

CARACAL (TW)

CARAT (DE)

- YALE (212)

CARL F (GB)

CAROLI (IT)

- MERONI (136)

C.A.R.S. (IT)

- OMA (148)

CASAS (ES)

- AGA (11)

CAS-CISMA (IT)

- BV
- CAB
- DOMUS
- ETNA
- FTH
- GSA
- GUARDIAN
- LAPERCHE
- M
- MERONI
- MST
- SISO
- SOBINCO
- STIQAM
- STREMLER
- TECHNAL
- TESTA

PER:
FOR:

CAS-CISMA

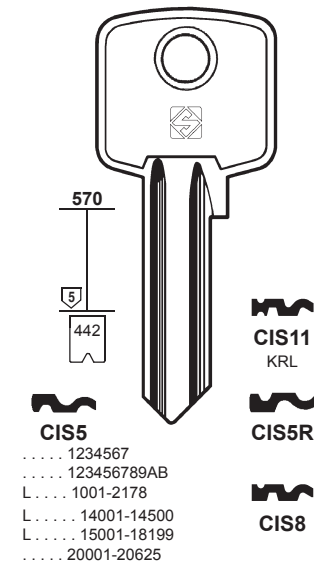

CIS5

- 1234567
- 123456789AB
- L..... 1001-2178
- L..... 14001-14500
- L..... 15001-18199
- 20001-20625

ETNA - FTH - GSA - LAPERCHE
STREMLER - TECHNAL

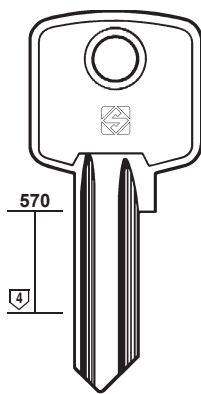

CIS11
KRL



CIS5R



CIS8

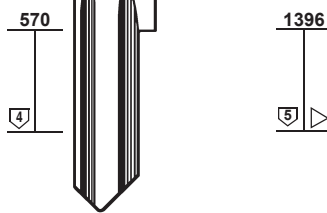

CIS6



CIS6R

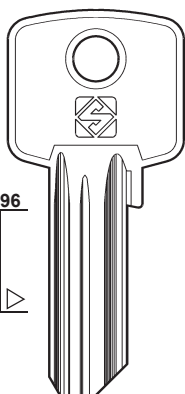

CIS9

- 12345678AB
- 12345678



CIS12

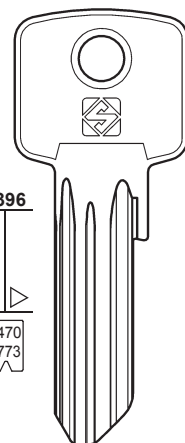

1470
2773



CIS12X

- 12345678

MERONI - SOBINCO

PER:
FOR:

CAS-CISMA

CASH-BOX

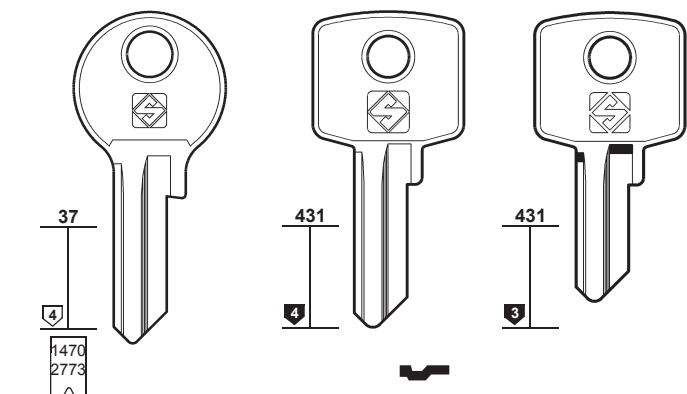

37

4

1470
2773

431

4

431

3



CIS2



CIS7



CIS4



CIS4R



CIS1



CIS3



BV - CAB - DOMUS - GUARDIAN
M - MST - SISO - STIQAM - TESTA

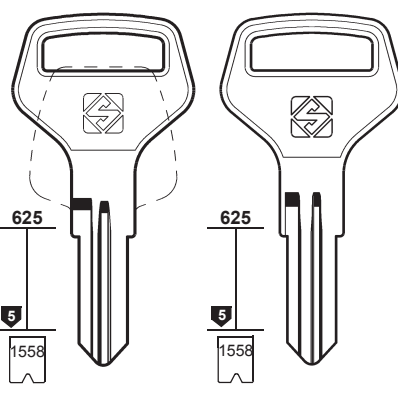

625

5

1558

- ... 101-170
- ... 201-270



CAX1R

625

5

1558

- ... 0-1-2
- ... 301-370



CAX2R



CASI (DE)

- SCHLECHTENDAHL (166)

CASIO (IT)

- OLIVETTI (148)

CASH-BOX (DE)

- + CLAUSOR (59)
- + KIFERM (117)

CASMA (IT)

- CES (48)
- P.C. (154)

CATOR (FR)

- RONIS (161)

CAVERS (FR)

- AZBE (27)
- CISA (55)
- CITY (58)
- SPIDER (174)



46

PER / FOR

CAYS (ES)

CCC (IL)

CDP (NL)

CEE (PT)

CCL (FR)

CORBIN (62)

CEKA (DE)

HUWIL (104)

CEMA (IT)

ELFIN

LAMPA

CENTURY (GB)

ALLGOOD

PER: FOR:	CAYS	CCC	CDP
	 10 1129 S127 mm 27 0-1-2-3-4-5-6-7-8-9 CYS1 CYS1R CYS2	 431 CCC1 CCC1R	 214 CDP1R

PER: FOR:	CEE	CEMA	CENTURY
	 A CEE1	 73 552 CM3 E.. 1-78 CM4 G.. 1-78 CM2 CM1 ELFIN - LAMPA	 185 CEN4R
		 73 5 CM3R F.. 1-78 CM4R H.. 1-78 GT4 GT4R CM2R CM1R	

PER: FOR:	CENTURY			
	 182 CEN1 CEN1R	 N CEN2 CEN2R	 171 CEN3	 577 CEN5T ø 7.5 ø 10
	ALLGOOD			

PER:
FOR:

CES

CE147
255
7
mm 27,5

CE4
69
6
223
414
mm 23

CE8
69
6
223
1544
2320
mm 23

CE7
69
5
mm 21

CE18
69
4
223
1594
mm 18

CE6
ELZETT
FRECOV
HÄFELE
HANNO
JOSTA
KARDEX
KIND
KNAPP
MAUSER
NEMEF
OJMAR
VOKO
WASO
WECO

CE6R
BODA
ELZETT
FRECOV
KNAPP

CE4R
BODA
ELZETT
FRECOV
KNAPP

CE8
12345678

CE9
12345678

CE7R
FRECOV
HÄFELE
HANNO
JOSTA
KARDEX
KIND
KNAPP
MAUSER
NEMEF
OJMAR
SÄNTIS
VOKO
WASO
WECO

CE34
123456789

CE10

CE35
123456789

CE21R
WS ... 401-410

CE36
123456789

CE29R

CE18
N ... 1-50
... 101-400

CE18R

STUV



47

PER / FOR

CES (DE)
BERRY
BODA
BOTT
COMBA
ELZETT
FEFI
FRECOV
FUHR
GIESCHE
HÄFELE
HANNO
HÖHRMANN
JOSTA
KARDEX
KIMA
KIND
KNAPP
MAUSER
MBB
NEMEF
OJMAR
OTIS
SÄNTIS
SIEBAU
SOLID
SS
STUV
TORE
TRITON
VOKO
WASO
WECO

PER:
FOR:

CES

CE33
295
4
mm 18,5

CE13
37
3
mm 15,5

CE13R
3
mm 15,5

CE11
2

CE11R
BOTT

CE19
385
mm 15

CE30
215
3

CE13
ELZETT
FRECOV
HÄFELE
HANNO
JOSTA
KARDEX
KIND
KNAPP
MAUSER
NEMEF
OJMAR
VOKO
WASO

CE13R
BODA
ELZETT
FRECOV
KNAPP

CE11R
BOTT

CE19
CE19R

CE30
CE30R

STUV

PER:
FOR:

CES

CE3
68
6
643
mm 33

CE1R
OV
6
357
557
mm 31,5

CE5
OV
5
357
mm 28

CE2R
OV
5
357
557
mm 28

CE2X

CE1
FUHR
GIESCHE
HÖHRMANN
KIMA
NEMEF
SIEBAU
SOLID
SS
STUV

CE2
BERRY
COMBA
FEFI
HÄFELE
HÖHRMANN
MBB
NEMEF
OTIS
SANTIS
SOLID
STUV
TORE
TRITON

1-2-3-4-5-6-7-8-9-0
BB ... 1-12000
BBF ... 1-12000
BT ... 1-12000
TS ... 1-12000

CE3
1-2-3-4-5-6-7-8-9-0
BODA

CE3R

CE1R
SOLID

CE5

CE2R
SOLID
TORE

CE2X



48

PER / FOR

CES (DE)
CASMA
HÄFELE
NEMEF
SPEEDAL

PER:
FOR:

CES

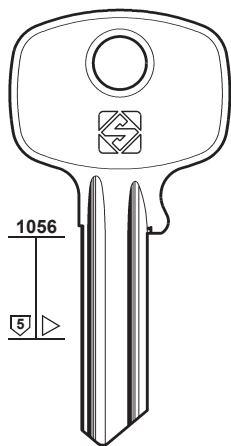

CE40

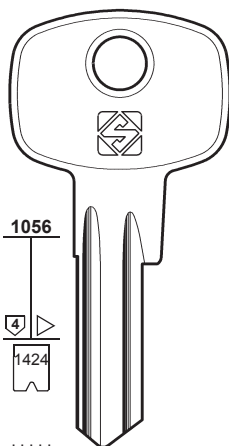

CE41

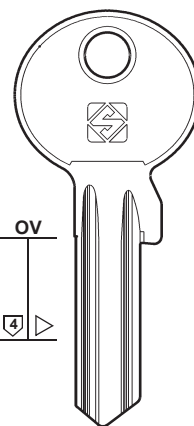

CE41X-OV

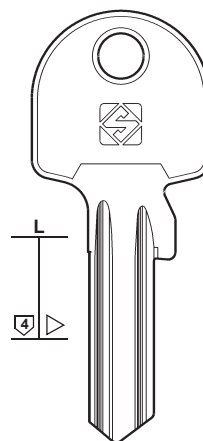

CE41XL

HÄFELE

PER:
FOR:

CES

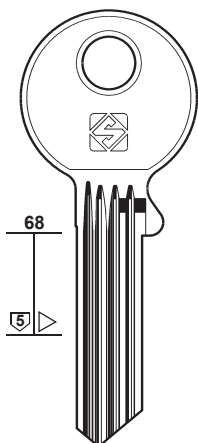

CE17XPS

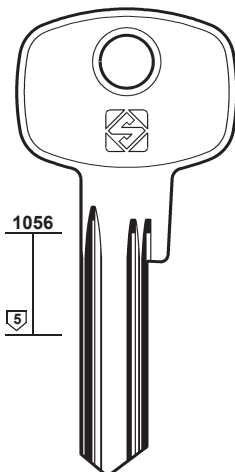

CE127

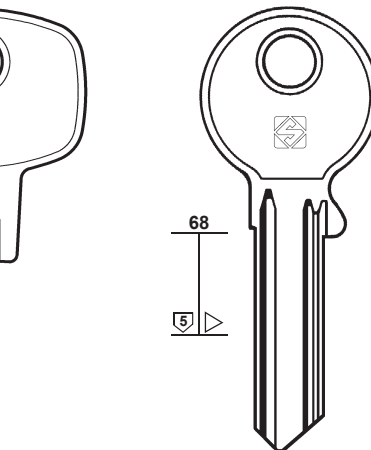

CE155

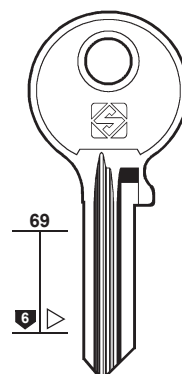

CE153R

CE17WPS

CE150

NEMEF

CE154

CE20

CE114

NEMEF

PER:
FOR:

CES

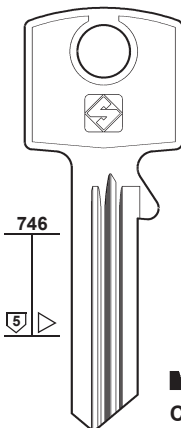

CE23R

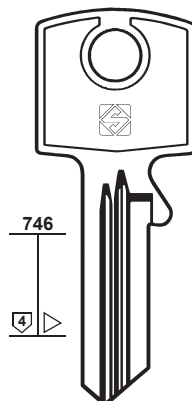

CE24R

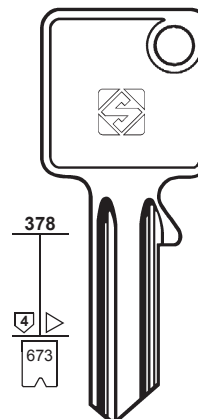

CE12
..... 1234567890

CE28

CE31

CE32R

CE27

CE25R

CE26R

CASMA - SPEEDAL

PER:
FOR:

CES



49

PER / FOR

CES (DE)
BODA

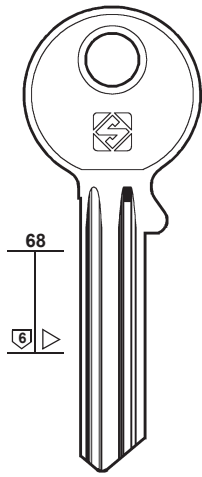

CE149

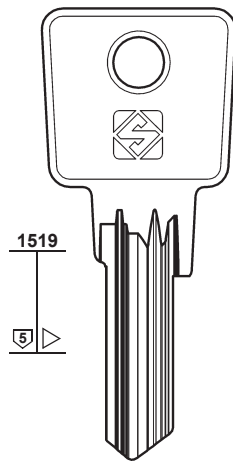

CE158

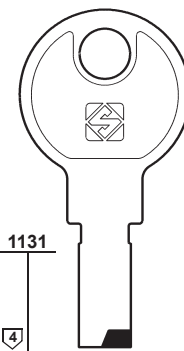

CE131



PER:
FOR:

CES

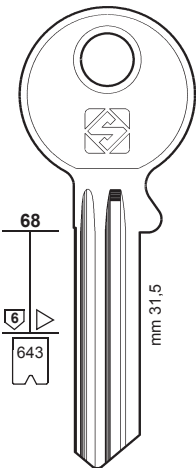

K CE15 **CE39**
TB CE16

- | | |
|--------------------------------------|-------------------|
| 15 CE14-15 | 35 CE14-35 |
| 16 CE14-16 | 36 CE14-36 |
| 17 CE14-17 | 37 CE14-37 |
| 18 CE14-18 | 38 CE14-38 |
| 25 CE14-25
.....1234567890 | 45 CE14-45 |
| 26 CE14-26 | 46 CE14-46 |
| 27 CE14-27 | 47 CE14-47 |
| 28 CE14-28 | 48 CE14-48 |

BODA

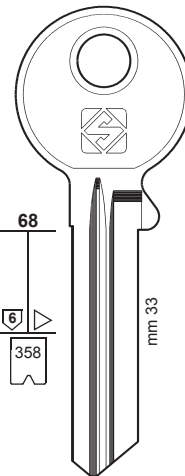

- | | |
|--|-------------------|
| 15 CE22-15 | 35 CE22-35 |
| 16 CE22-16
1Z 1-100000 | 36 CE22-36 |
| 17 CE22-17 | 37 CE22-37 |
| 18 CE22-18 | 38 CE22-38 |
| 25 CE22-25 | 45 CE22-45 |
| 26 CE22-26 | 46 CE22-46 |
| 27 CE22-27 | 47 CE22-47 |
| 28 CE22-28 | 48 CE22-48 |

BODA

PER:
FOR:

CES

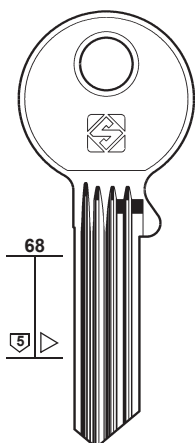

- | | | | | | |
|----------------|----------------|----------------|----------------|----------------|----------------|
| CE17W23 | CE17W30 | CE17W37 | CE17X23 | CE17X30 | CE17X37 |
| CE17W24 | CE17W31 | CE17W38 | CE17X24 | CE17X31 | CE17X38 |
| CE17W25 | CE17W32 | CE17W39 | CE17X25 | CE17X32 | CE17X39 |
| CE17W26 | CE17W33 | CE17W40 | CE17X26 | CE17X33 | CE17X40 |
| CE17W27 | CE17W34 | CE17W41 | CE17X27 | CE17X34 | CE17X41 |
| CE17W28 | CE17W35 | CE17W42 | CE17X28 | CE17X35 | CE17X42 |
| CE17W29 | CE17W36 | | CE17X29 | CE17X36 | |



50

PER / FOR

CES (DE)
BODA
THOMEE

PER:
FOR:

CES

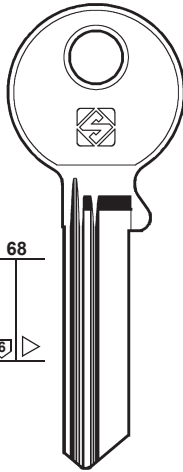

CE38W23

CE38W28

CE38W33

CE38W38

CE38W24

CE38W29

CE38W34

CE38W39

CE38W25

CE38W30

CE38W35

CE38W40

CE38W26

CE38W31

CE38W36

CE38W41

CE38W27

CE38W32

CE38W37

CE38W42

PER:
FOR:

CES

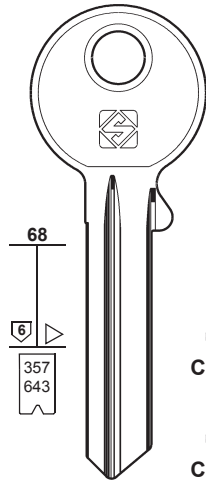

.....
1-2-3-4-5-6-7-8-9-0

CE129-1
R/8

CE129-2
Z/568

CE129-3
1/678

CE129-4
2/568

CE129-5
R/7

CE129-6
Z/68

CE129-7
G/56

CE129-8
G/68

CE129-9
R/R

CE129-10
G/5

CE129-11
G/6

CE129-12
3/567

CE129-13
G/67

CE129-14
3/R

CE129-15
3/568

CE129-16
Y/567

CE129-17
G/57

CE129-18
2/R

CE129-19
1/56

CE129-20
Y/68

CE129-21
1/67

CE129-22
3/68

CE129-23
G/678

CE129-24
3/58

CE129-25
3/678

CE129-26
4/578

CE129-27
4/568

CE129-28
3/57

CE129-29
G/568

CE129-30
4/678

CE129-31
3/578

CE129-32
2/57

CE129-33
Z/67

CE129-34
G/578

CE129-35
1/567

CE129-36
1/G

CE129-37
4/58

CE129-38
X/R

CE129-39
4/78

CE129-40
1/568

CE129-41
G/8

CE129-42
G/7

CE129-43
X/6

CE129-44
4/56

CE129-45
Y/5

CE129-46
Z/7

CE129-47
2/56

CE129-48
G/58

CE129-49
2/67

CE129-50
2/68

CE129-51
4/567

CE129-52
4/G

CE129-53
1/78

CE129-54
X/G

CE129-55
3/78

CE129-56
Z/5

CE129-57
2/G

CE129-58
2/578

CE129-59
Z/G

CE129-60
Z/56

CE129-61
Y/78

CE129-62
X/58

CE129-63
Y/67

CE129-64
4/R

CE129-65
Y/56

CE129-66
Z/567

CE129-67
Y/G

CE129-68
Z/78

CE129-69
Y/7

CE129-70
2/58

CE129-71
X/7

CE129-72
1/58

CE129-73
4/57

CE129-74
X/67

CE129-75
Y/6

CE129-76
3/56

CE129-77
G/G

CE129-78
Y/57

CE129-79
Y/8

CE129-80
Z/8

CE129-81
2/567

CE129-82
X/8

CE129-83
Y/58

CE129-84
3/67

CE129-85
2/78

CE129-86
Z/6

CE129-87
3/G

CE129-88
2/678

CE129-89
X/5

CE129-90
R/6

BODA - THOMEE

PER:
FOR:

CES

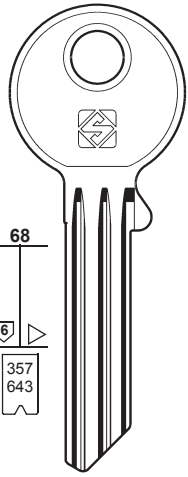

1-2-3-4-5-6-7-8-9-0

 CE130-1 C/2	 CE130-2 B/2	 CE130-3 B/1	 CE130-4 C/4	 CE130-5 A/4	 CE130-6 A/5	 CE130-7 C/5
 CE130-8 C/1	 CE130-9 A/2	 CE130-10 D/1	 CE130-11 A/34	 CE130-12 B/3	 CE130-13 X/678	 CE130-14 1/68
 CE130-15 4/67	 CE130-16 4/68	 CE130-17 AB5	 CE130-18 B/15	 CE130-19 C/15	 CE130-20 AD1	 CE130-21 AD4
 CE130-22 A1-5	 CE130-23 AB1-3	 CE130-24 D1-5	 CE130-25 D/2	 CE130-26 D/5	 CE130-27 D/4	 CE130-28 A/3
 CE130-29 C/34	 CE130-30 C/3	 CE130-31 B/34	 CE130-32 B/5	 CE130-33 B/4	 CE130-34 D/3	 CE130-35 A/1

BODA - THÖMEE



51

PER / FOR

CES (DE)
BODA
THÖMEE

CEV (IT)
IDRO-STOP (105)

CF (FR)
FTH (91)

CFP (DE)
WILKA (210)

CHANGE-O-MATIC (FR)
CORBIN (62)

CHAVO (PT)
+ CISA (55)
+ SOFI-SONAFI (172)

CHEK (HK)
CHEYLOCK

CHELIABINSK (RU)

CHEYLOCK (HK)
CHEK (51)

CHG (FR)
GABON (93)

CHICAGO (US)
FORT
ILLINOIS
ODA

PER:
FOR:

CHAVO

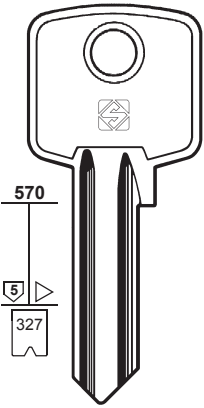

CHV1 CHV1R

CHEK

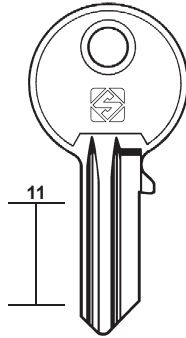

CK1



CHELIABINSK

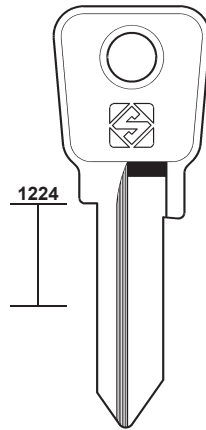

CLK1

CHICAGO

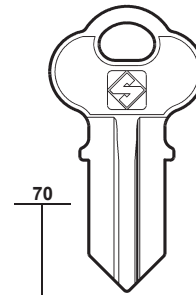

CH1 CH2
CH3 CH4
CH5 CH8



PER:
FOR:

CHICAGO

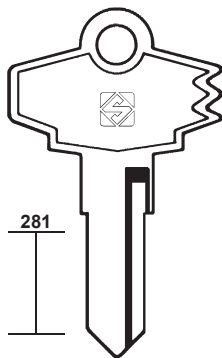

CH6



ILLINOIS - ODA

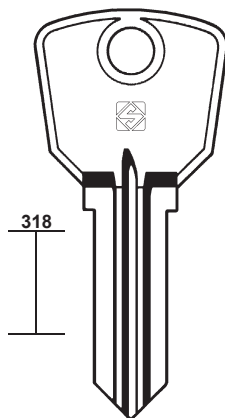

CH7 CH7R



FORT

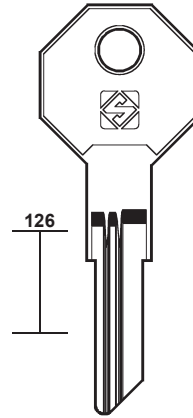

CH15





52

PER / FOR

CHICAGO (US)

- ACE
- ADEMCO
- AGA
- ALPHA
- EURO LOCKS
- FORT
- GEM
- IFAM
- L & F
- STEELCASE

CHRIST (DE)

- DOM (68)
- HUWIL (104)

CHSS (TW)

CHUBB (GB)

- AVA-CHUBB (26)

CIAL (BR)

CIB (FR)

- FTH (90)
- OMIV (149)
- PREFER (157)
- UCEM (192)

CIBC (IT)

- CISA (57)
- FTH (90)

CIC (IT)

- BASI (31)
- CORNI (62)

PER:
FOR:

CHICAGO

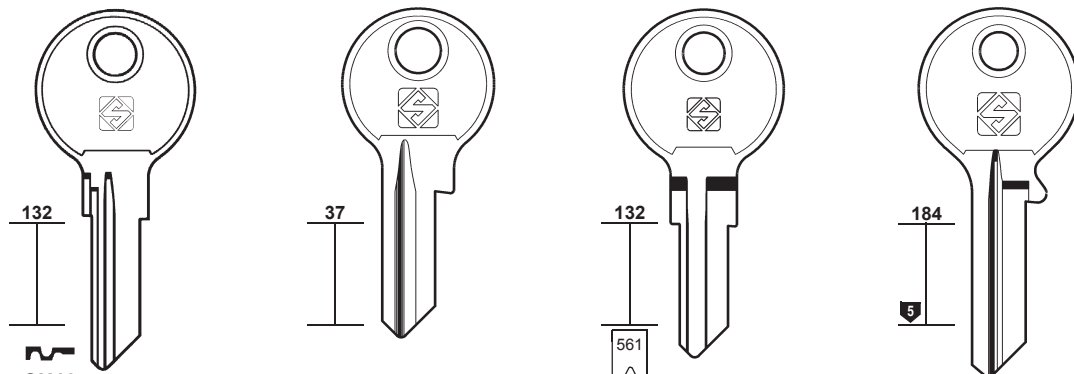

CH18

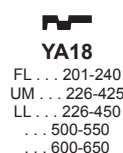

STEELCASE

PER:
FOR:

CHICAGO

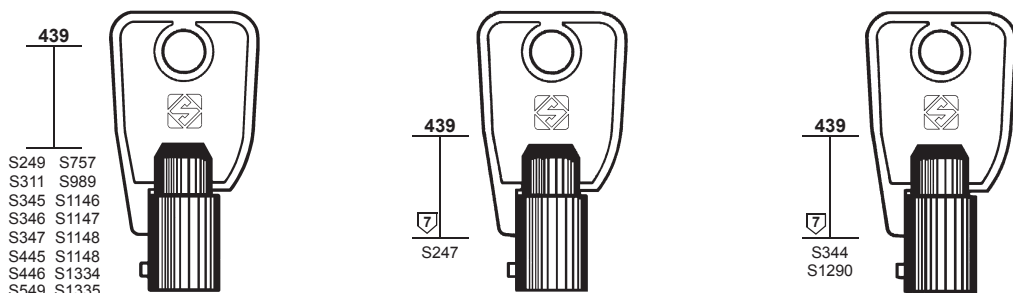

- S249 S757
- S311 S989
- S345 S1146
- S346 S1147
- S347 S1148
- S445 S1148
- S446 S1334
- S549 S1335
- S550

- S247

- S344
- S1290

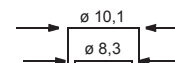
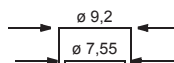
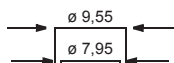

- ... 1-999
- ... 2001-2100
- ... 0123
- ... 7654321
- ... 7654321
- ... 7654321
- ... 1234567
- ... 280001-285000
- ... 320001-326000
- ... 24568ABCDEFGHIJKLMNO

- ... HD 0001-9400
- ... HD ... 0001-9400
- ... HMC ... 00001-31000

- ... 7-6-5-4-3-2-1

- ... 123456
- ... X123456

ACE - ADEMCO - AGA - ALPHA
EURO LOCKS - FORT
GEM - IFAM - L & F

PER:
FOR:

CHSS

CHUBB

CIAL

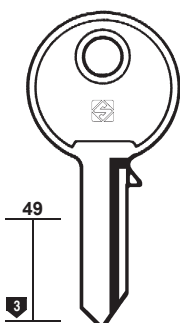

CHS1



mm 30

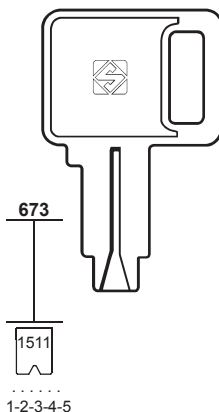

CHU5

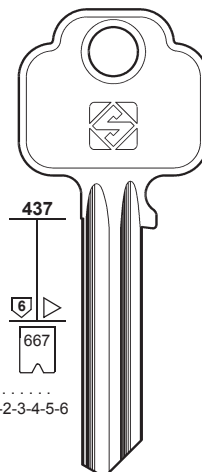

CHU6

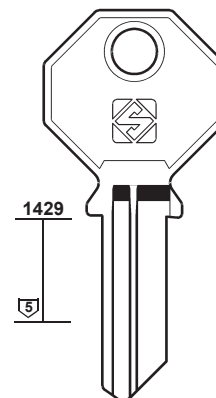

CIA1

PER:
FOR:

CIEF

CIELS



53

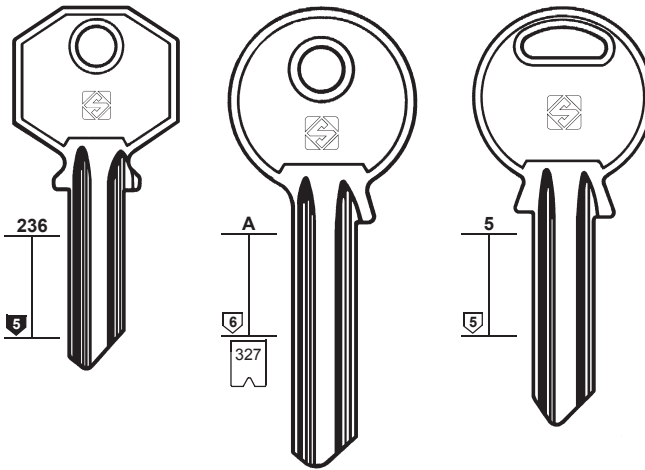
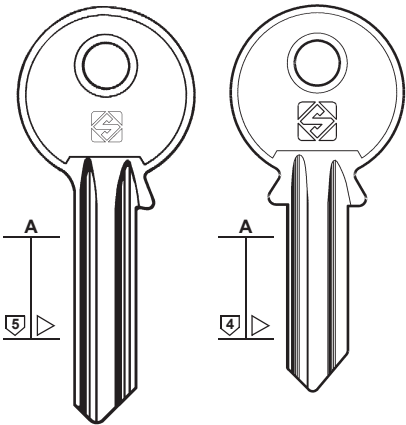

PER / FOR

CIEF (FR)

CIELS (IT)

CIERRA SOLA (AR)

CIFIAL (PT)
LE FEBURE

CIGNO (IT)
CISA (57)

CIL LIL (IL)

CILA-GENTILI (IT)

CIERRA SOLA

CIFIAL

CIL LIL

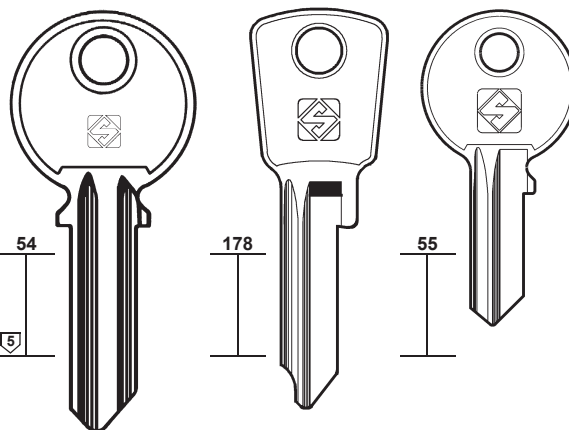
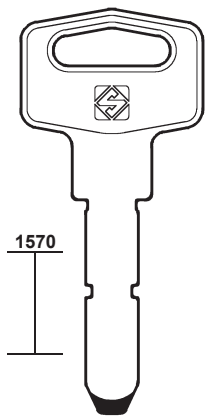

LE FEBURE

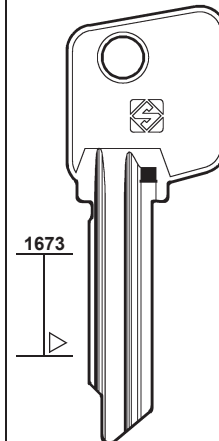

PER:
FOR:

CILA-GENTILI

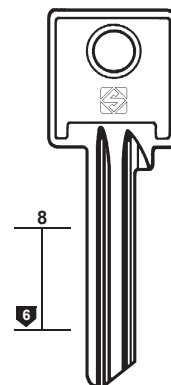
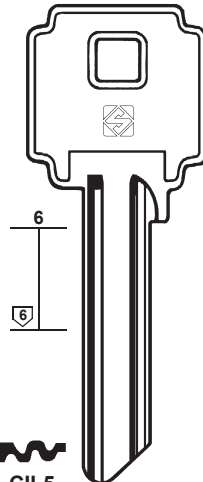
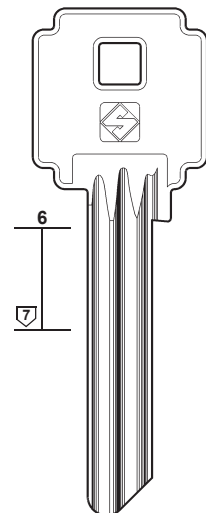
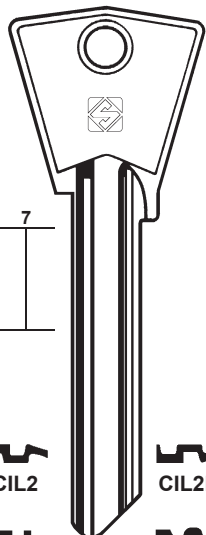



54

PER / FOR

CINA (TW)

555
ABUS
ALI
BAODEAN
EIKO
HOOPLY
MASTER LOCK
MSM
SHANGHAI
+ SHANGHAI (168)

PER:
FOR:

CINA

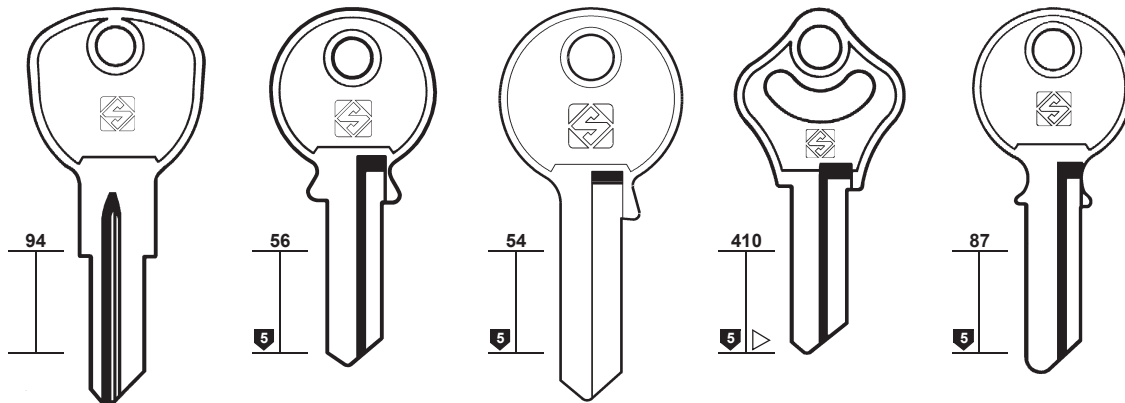

RC1R



A303



C303



AS1



mm 45



SG808



SG808R



SHANGHAI



SG1



SHANGHAI

PER:
FOR:

CINA

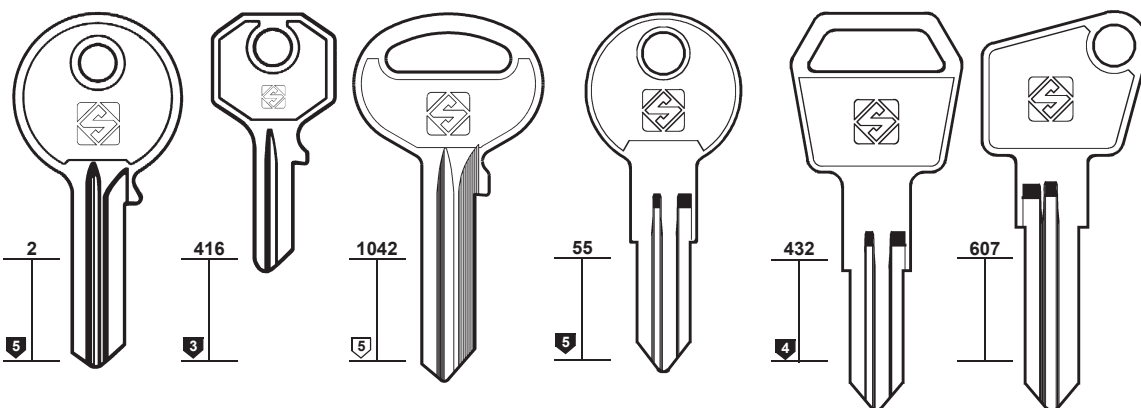

454



C555



555



RC3R

ALI - EIKO



RC4



RC5



RC5R



RC6



RC6R



RC7R



PER:
FOR:

CINA

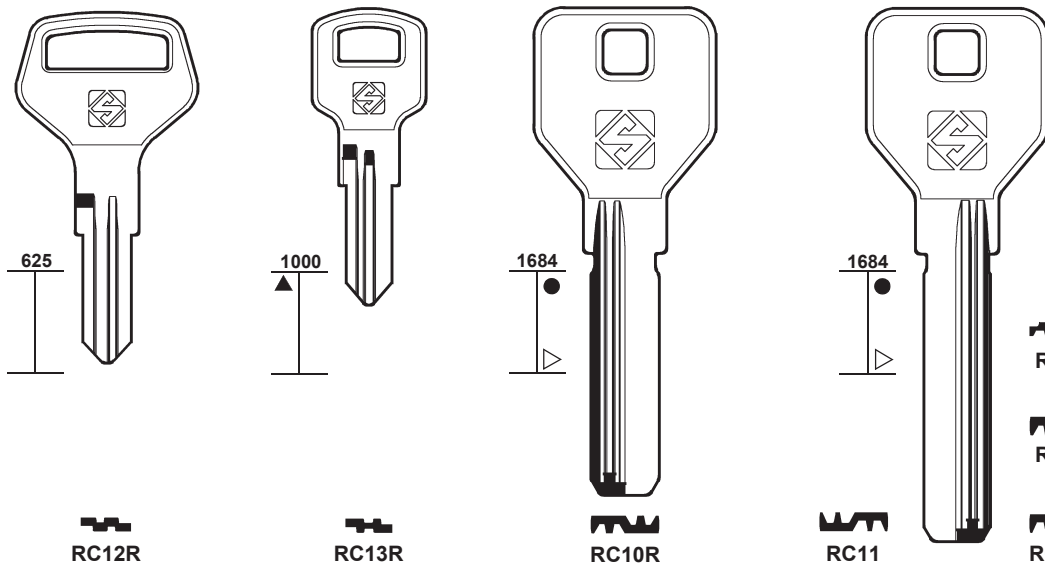

RC12R



RC13R



RC10R



RC11



RC9R



RC8R



RC11R



BAODEAN - HOOPLY
MASTER LOCK - MSM

PER:
FOR:

CINA

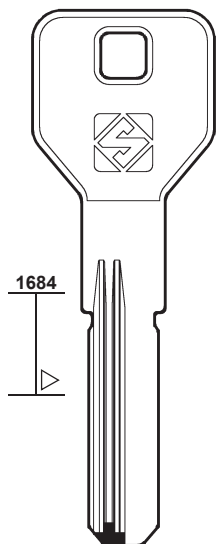

RC15R

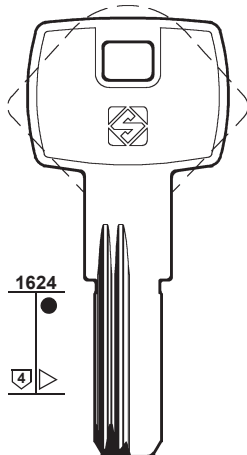

RC16R

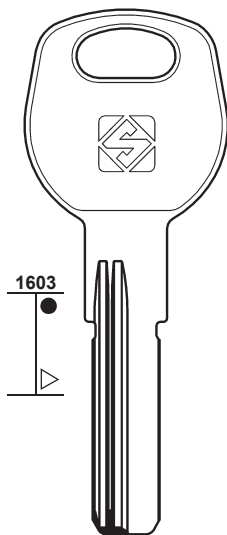

RC17R

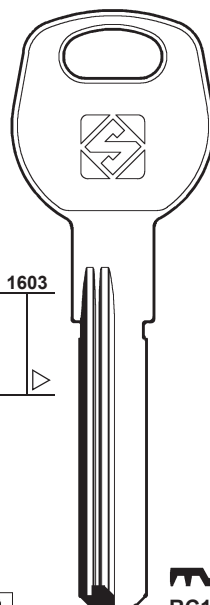

RC14R

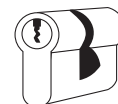

55

PER / FOR

CINA (TW)
+ SHANGHAI (168)

CISA (IT)
ABUS
ALA
ALF
BRICARD
CAVERS
CHAVO
DOBUS
ESCO
ESSENDIA
GEFI
GETE
GEVY
GTV
ITO
LOGO
NB
SCHÜCO
STANDARD
TIEFENTHAL
TZAFRER
UNIFERRO
+ ABUS (6-7-8-10)
+ ALA (14)

PER:
FOR:

CISA

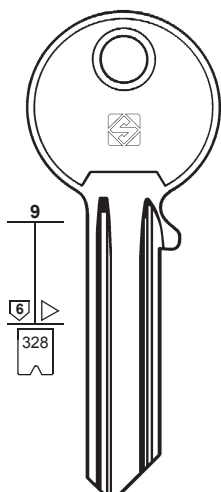

CS501R

CS501

..... 1-2-3-4-5

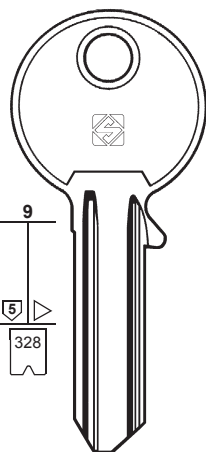

CS500R

CS500

..... 1-2-3-4-5

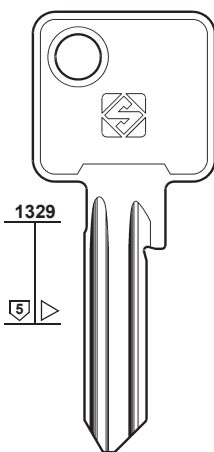

CS85

mm 50-55-60-65
70-75-77-84-94



ABUS

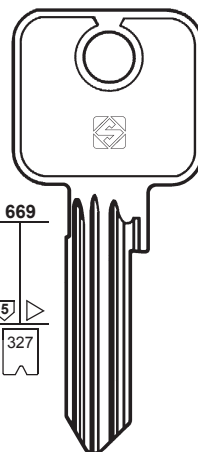

CS17

CS17R

..... 1-2-3-4-5-6

ALA

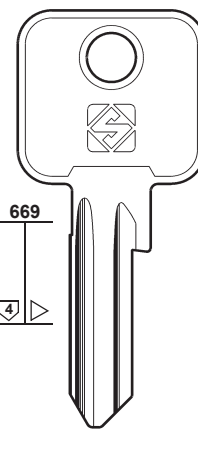

CS47

CS47R



mm 70 ABUS

PER:
FOR:

CISA

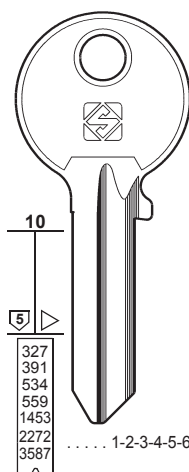

CS206

AY 1-6032
BA 1-6032
BB 1-6032
BC 1-6032
BD 1-6032
BJ 1-6032
BK 1-6032
BL 1-6032
BM 1-6032
BN 1-6032
BP 1-6032
BQ 1-6032
BR 1-6032
BS 1-6032
BT 1-6032
BU 1-6032
BY 1-6032
SA 1-6032
SB 1-6032
..... 123456
..... 123456789

CS207

ABUS
CAVERS
ESCO
ESSENDIA
GEFI
GETE
GTV
NB
SCHÜCO
STANDARD
..... 1-2-3-4-5-6
E 1234567890ABCDEF GHI



mm 50-60

CS13

BRICARD

CS13R

BRICARD

CS14

CS14R

CS15

CS15R

CS162

CS18

LOGO

CS18R

LOGO

CS68

CS24

LOGO

CS24R

LOGO

CS88

CS31

CS31R

CS138

G08D

CS38

CS38R

CS142

CS44

CS44R

CS143

CS49

G28D

CS50

G16D

CS147

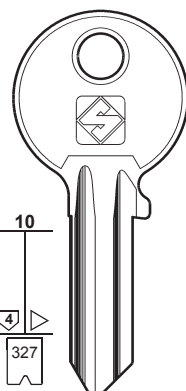

CS16

LOGO

..... 1-2-3-4-5-6

CS16R

LOGO

CS25

LOGO

CS25R

LOGO

CS30

CS30R

CS34

CS34R

CS36

CS41

CS204

CS205

..... 1-2-3-4-5-6

CS37

CS37R

CS42

G28D

CS43

G16D

CS105

CS67



DOBUS - GEVY - TZAFRER



56

PER / FOR

CISA (IT)

ABUS

BRICARD

ESLA

JPM

+ ABUS (6-7-8-10)

+ ALA (14)

PER:
FOR:

CISA

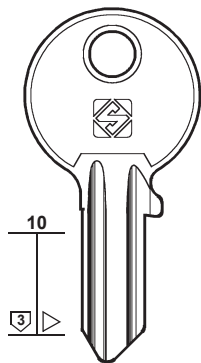

10
3

CS66

CS4

CS4R

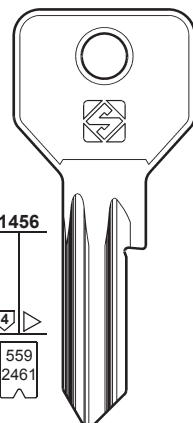

1456
4
559
2461

CS120

CS120R

..... 1-2-3-4-5-6-7-8
..... (C 2000) 1-2-3-4-5-6-7-8

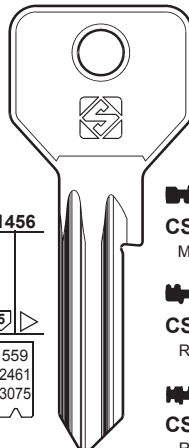

1456
5
559
2461
3075

CS170
M080

CS168
R035

CS152
R027

CS119

CS119R

..... 0-1-2-3-4-5-6-7-8
..... 1-2-3-4-5-6-7-8
..... (C 2000) 1-2-3-4-5-6-7-8

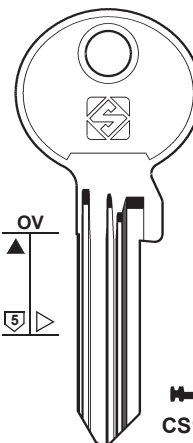

OV
5

CS163X
ABUS

CS13X
BRICARD

CS52X
G14D



PER:
FOR:

CISA

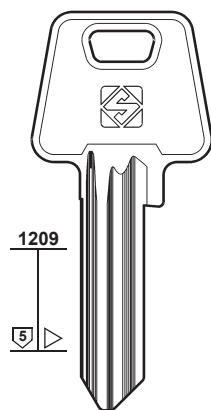

1209
5

CS61

JPM

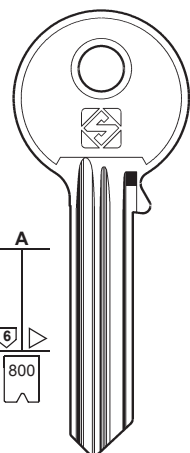

A
6
800

CS121

..... 0-1-2-3-4-5-6-7-8-9

ESLA

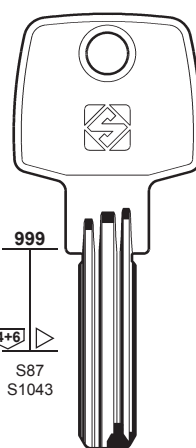

999
4+6
S87
S1043

CS48

A/Z A/Z A/Z
000001-030198



ABUS
BRICARD

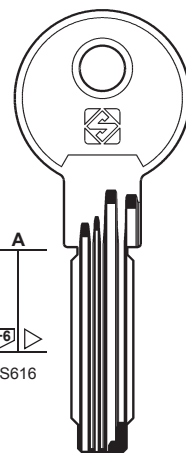

A
6+6
S616

CS70 W60

..... AM 1-38832 AM



ASIX

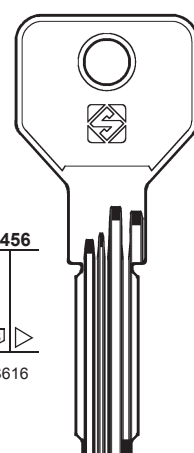

1456
6+6
S616

CS146

..... AM 1-38832 AM



ASIX

PER:
FOR:

CISA

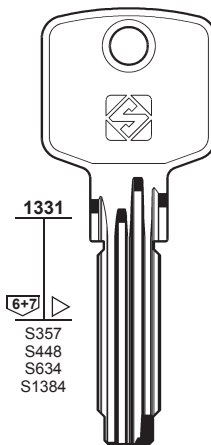

1331
6+7
S357
S448
S634
S1384

CS144



..... (XN008710) 1-11808
..... (XN005710) 1-38832
..... 900001-944826

W08

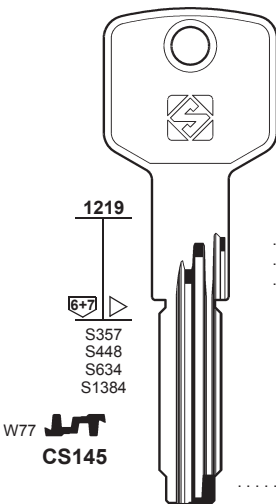

1219
6+7
S357
S448
S634
S1384

CS145

CS139

..... (XN008710) 1-11808
..... (XN005710) 1-38832



(W08)
CS62

..... (XN008710) 1-11808
..... (XN005710) 1-38832
..... 900001-944826

W05
CS115
BRICARD

W70
CS141

..... (XN008710) 1-11808
..... (XN005710) 1-38832

W72
CS140

..... (XN008710) 1-11808
..... (XN005710) 1-38832

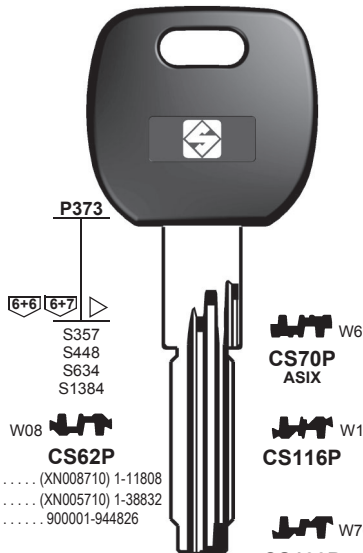

P373
6+6 | 6+7
S357
S448
S634
S1384

W60
CS70P
ASIX

W13
CS116P

W76
CS139P



NEW ASTRAL

Copyright by Silca S.p.A. 2018 - All Rights Reserved

PER:
FOR:

CISA



P468

6+7

S357
S448
S634
S1384

W08 **CS62AP**

..... 900001-944826
..... (XN008710) 1-11808
..... (XN005710) 1-38832



CS155AP

CS154AP

W76 **CS139AP**

W13 **CS116AP**

W60 **CS70AP**

CS159AP

CS158AP

CS157AP

CS156AP



57

PER / FOR

CISA (IT)

ABUS

ALA

BATU

CIBC

CIGNO

IFAM

KUNERT

LOGO

LOK 2000

+ ABUS (6-7-8-10)

+ ALA (14)

PER:
FOR:

CISA

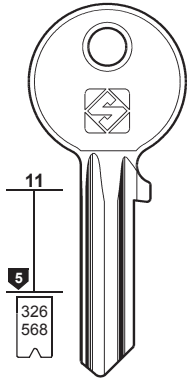

CS21 **CS21R**

..... 1-2-3-4-5-6

CS7 **CS7R**

A..... 1-01321
..... 1-2-3-4-5-6



mm 40

BATU - CIBC
IFAM - KUNERT - LOGO

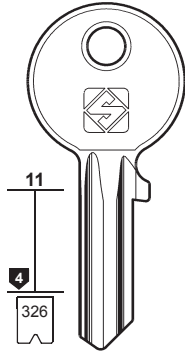

CS6 **CS6R**

..... 1-2-3-4-5-6
EA... 1-738



mm 30

ABUS

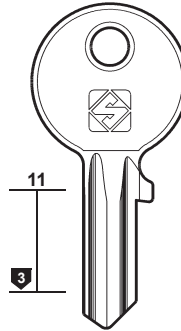

CS5 **CS5R**

LOK 2000
ABUS

PER:
FOR:

CISA

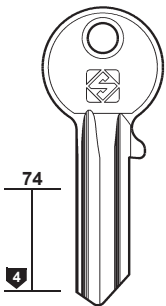

CS22 **CS22R**
LOGO **LOGO**

CS8 **CS8R**



mm 30

IFAM

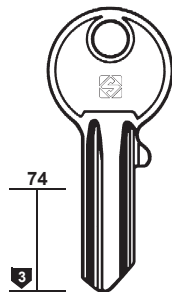

CS9 **CS9R**



mm 20-25

CIGNO

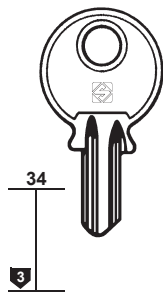

CS12 **CS12R**



mm 15

ABUS - ALA

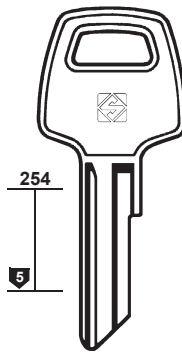

CS10 **CS10R**

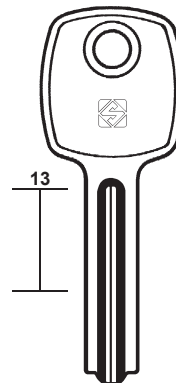

CS11





58

PER / FOR

CISA (IT)

BASI
CITY
IFAM
+ ABUS (6-7-8-10)
+ ALA (14)

CITY (FR)

ATP
CAP
CAVERS
FO
PROTEC
QCP
SIAM
SOS
VIP
ZENITH
+ BUGA (40)
+ CISA (58)
+ FTH (91)

CKS (DE)

YALE (212)

CLASSIC (DE)

ABUS (7)

PER:
FOR:

CISA

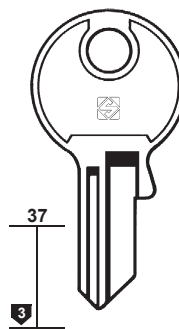
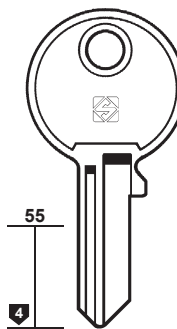
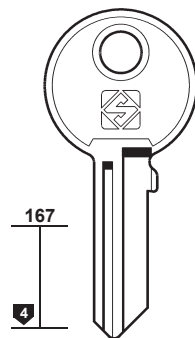
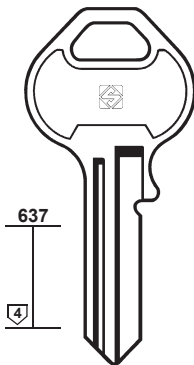
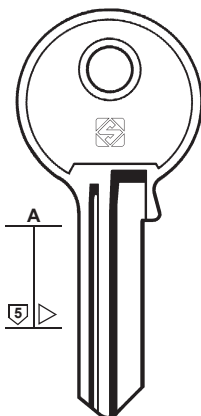

CS33 CS33R



BASI



CS32 CS32R



BASI - CITY



CS19 CS19R



BASI



CS26



CS26R



CITY



CS27



CS27R



PER:
FOR:

CISA

CITY

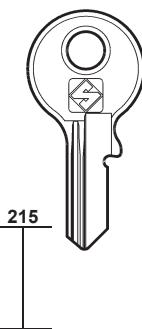

215



CS45



CS45R

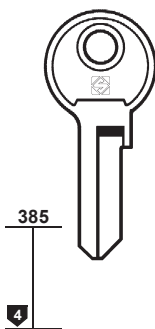

385



CS20



CS20R

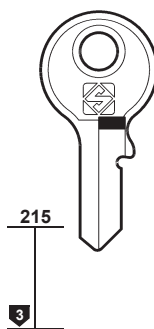

215



CS23



CS23R



BASI - IFAM



277



CS28



CS28R

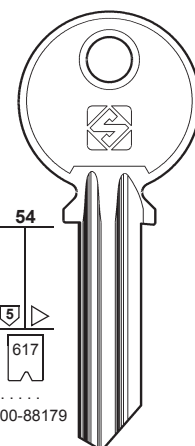

54

617

81000-88179



CA15

PER:
FOR:

CITY

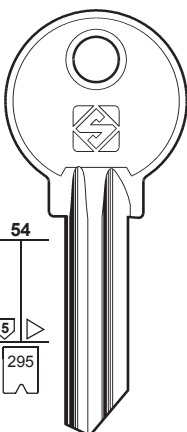

54

295



CA2R

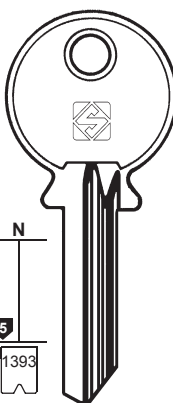

N

1393



CA2

160 ... 000-999
16 ... 1000-6288

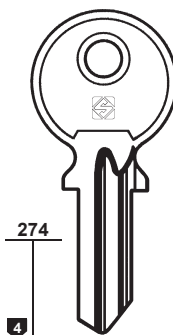

274

4



CA3

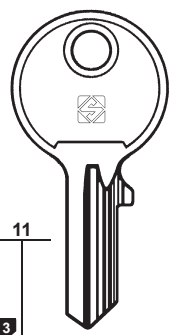

11

3



CA4

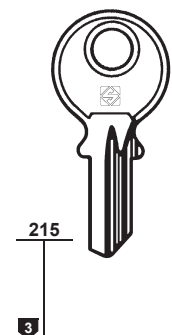

215

3



CA5

ATP - CAP - FO
PROTEC - QCP - SIAM
SOS - VIP - ZENITH

CAVERS

CAVERS

CAVERS

CAVERS

PER:
FOR:

CLAUSOR

CLUB

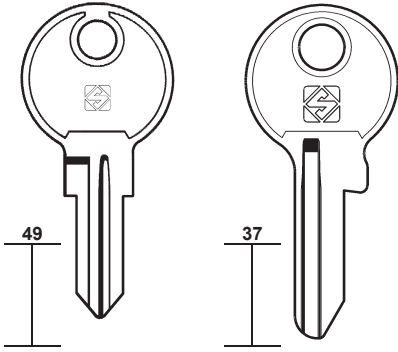

CR2R **CR5R**



**BRABANTIA
CASH BOX - ELSET**

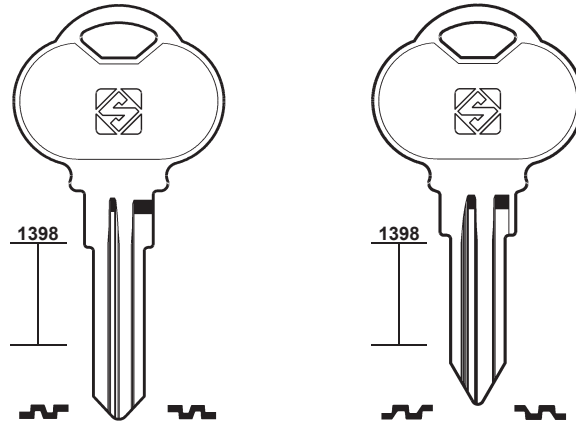

CLU1 **CLU1R** **CLU4** **CLU4R**
CLU2 **CLU2R**
CLU3 **CLU3R**



59

PER / FOR

CLAUSOR (ES)
BRABANTIA
CASH BOX
ELSET
+ ME-FA (135)

CLUB (US)

CODEM (FR)
FTH (92)

CODKEY (IL)
SPIDER (174)

COLE (US)
ROYAL

COLE-HERSEE (US)
YALE (213)

COLL (BY)

COLOMENCA (ES)
AGA (11)

COMBA (DE)
CES (48)
KFV (116)
TOK-WINKHAUS (186)

CONCEPT (BR)

CORBIN (IT)
MERMIER
OAL
POPLOCK

PER:
FOR:

COLE

COLL

CONCEPT

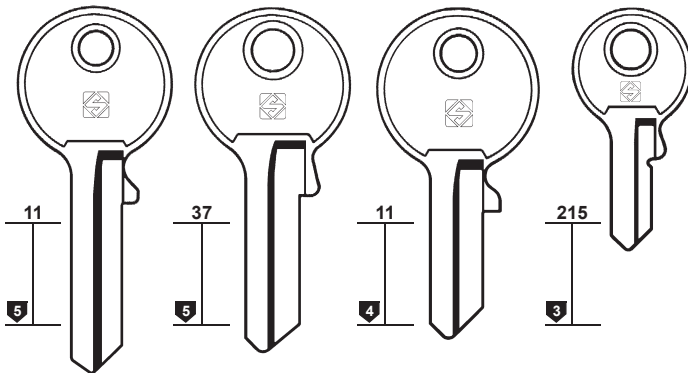

COL1 **COL2** **COL3** **COL4**



ROYAL

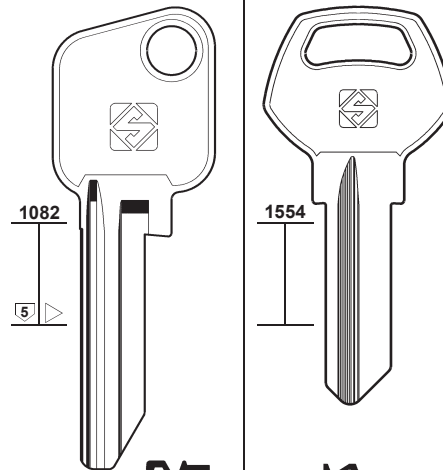

CLL1 **CNP1R**

PER:
FOR:

CORBIN (IT)

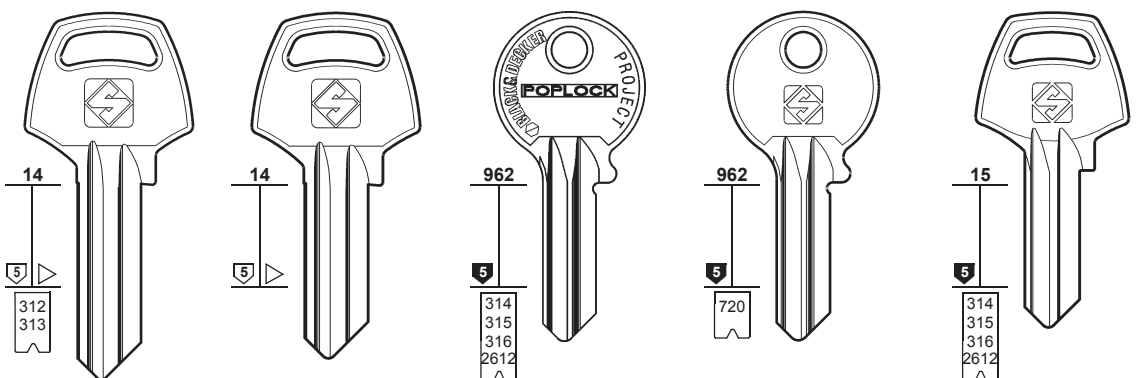

CB1 **CB1R** **CB2** **CB2R** **CB3-OR** **CB80** **CB3** **CB3R**

..... 2-3-4-5-6-7-8-9
..... 1-2-3-4-5-6-7-8-9

..... 1-2-3-4-5-6-7-8-9
..... 2-3-4-5-6-7
..... 1-2-3-4-5-6-7-8

..... 1-2-3-4-5

..... 1-2-3-4-5-6-7-8-9
..... 2-3-4-5-6-7
..... 1-2-3-4-5-6-7-8



mm 26-45-50-60



mm 23



mm 21-40



mm 21-40

MERMIER - OAL

OAL

POPLOCK

OAL



60

PER / FOR

CORBIN (IT)
 ALUNORM
 BWS
 CORNI
 CRC-CAMBÒA
 DOM
 ESCO
 EURONORM
 FEB
 HEGO
 HESTE
 ISSERSTEDT
 KAWE
 LITTO
 MERMIER
 MUKRA
 NEMEF
 NOVOFERM
 POPLOCK
 STREMLER
 SUL
 THÒNE
 VERSCO
 WÜRTH
 ZÈCE

PER: CORBIN (IT)
FOR:

Key 1: Length 963, bitting 4, bitting pattern 1-2-3-4-5

Key 2: Length 963, bitting 4, bitting pattern 1-2-3-4-5

Key 3: Length 15, bitting 4, bitting pattern 314, 315, 316, 2612

Key 4: Length 964, bitting 5, bitting pattern 323

Key 5: Length 964, bitting 3, bitting pattern 717

Key 6: Length 285, bitting 3, bitting pattern 323

Profiles: CB4-OR, CB81, CB4, CB4R, CB9-OR, CB79, CB9

Icons: POPLOCK, POPLOCK, mm 17,5, mm 11,5-20-25

PER: CORBIN (IT)
FOR:

Key 1: Length 11, bitting 5, profile CB85

Key 2: Length 37, bitting 5, profile CB15 025

Key 3: Length 277, bitting 4, bitting pattern 718, profile CB70

Key 4: Length 961, bitting 5, bitting pattern 317, 318, 327, 798, 1400, profile CB6-OR

Icons: POPLOCK

PER: CORBIN (IT)
FOR:

Key 1: Length 214, bitting 5, bitting pattern 317, 318, 1400, mm 28, profile CB6

Key 2: Length 214, bitting 5, bitting pattern 321, 322, mm 26, profile CB5

Key 3: Length 214, bitting 5, bitting pattern 321, 322, mm 25, profile CB5R

Key 4: Length 214, bitting 4, bitting pattern 319, 320, mm 23, profile CB8

Key 5: Length 214, bitting 4, bitting pattern 319, 320, mm 23, profile CB7

Key 6: Length 214, bitting 4, bitting pattern 319, 320, mm 23, profile CB7R

Profiles: CB6, CB6R, CB16 A1, CB105R, CB17, CB103R, CB19 B1, CB95R, CB32, CB96R, CB42, CB99R, CB43R, CB100R, CB78R, CB101R

Bitting patterns: 1-2-3-4-5-6-7-8-9, 0-1-2-3-4-5-6-7-8, 8-7-6-5-4-3-2-1-0, 012345678, 123456, DX 123456, 123456789, 876543210

Icons: BWS, ESCO - EURONORM, KAWE - MUKRA

PER:
FOR:

CORBIN (IT)

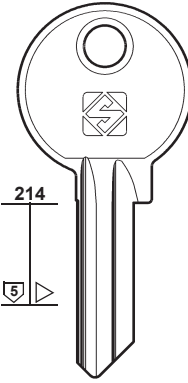
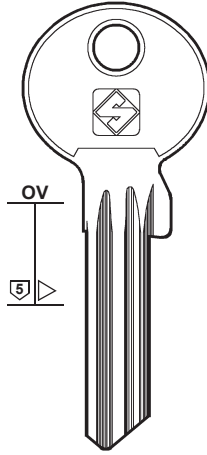
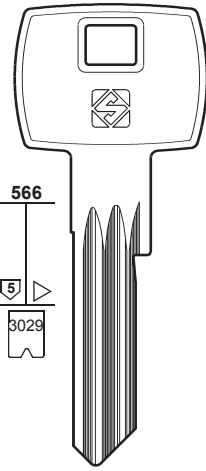
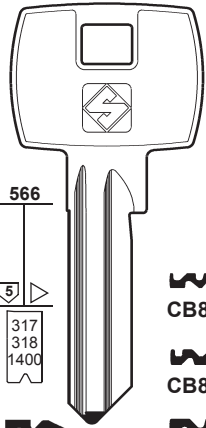

- CB89R**
- CB88R**
- CB31**
- CB84**
..... 1-2-3-4-5-6-7
- CB30**
- CB30R**
..... 1-2-3-4-5-6-7-8-9
..... 0-1-2-3-4-5-6-7-8
..... 8-7-6-5-4-3-2-1-0

- CB90R**
- CB86**
..... 1-2-3-4-5-6-7

- CB104R**
- CB106**

- CB21**

TESIO



61

PER / FOR

CORBIN (IT)
TESIO

CORBIN (US)
SKILMANN

PER:
FOR:

CORBIN (IT)

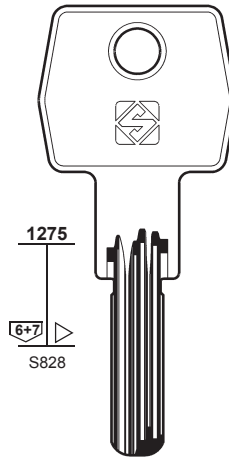
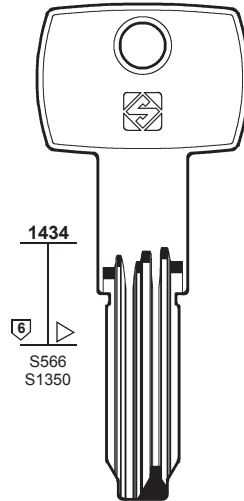
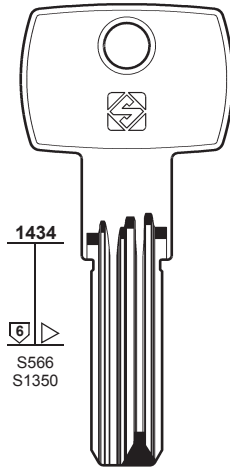
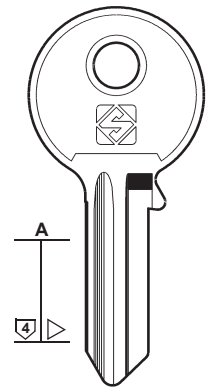

CB83

CB87

CB97

CB98



"Euro Star Plus"



PER:
FOR:

CORBIN (US)

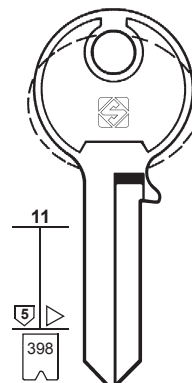
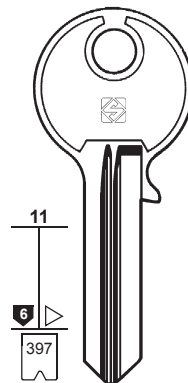
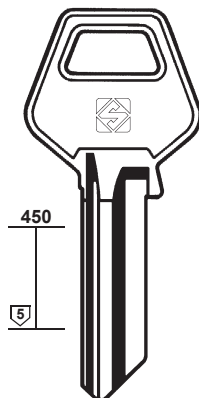
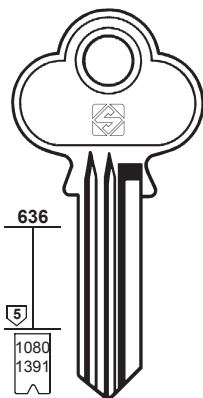
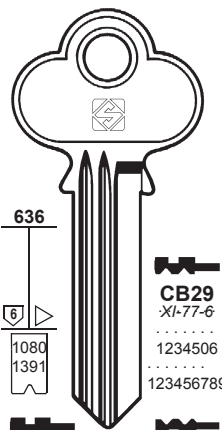

CB12

CB29R
..... 1234506
..... 123456789

CB11
XI-77-5
..... 1234567890

CB11R

CB18

CB28R
4R
0-1-2-3-4-5-6-7-8

9R
0-1-2-3-4-5-6-7-8

CB38

CB38R
B4R
0-1-2-3-4-5-6-7-8-9

4T
0-1-2-3-4-5-6-7-8-9

CB12R

CB82

CB37
..... 1234506
..... 1234567890

CB39R
..... 1234506
..... 1234567890

SKILMANN



62

PER / FOR

CORBIN (US)
CCL
CHANGE-O-MATIC
EMHART
LANE

CORNI (IT)

333
BETA
CIC
EURONORM
FONTAINE
MUL.T.LOCK
+ CORBIN (60)

PER: CORBIN (US)
FOR:

CB34R 1234567
CB25R 1234506
CB40R 1234506
 1234567890
 M 1234567890
CB26R 1234506
 0123456789A
 M 1234567890
CB33R 1234506
 1234567
CB27R 1234506
 1234567890
 M 1234567890
CB22R
CB23R 1234567890
 M 1234567890
CB24R 1234567890
 M 1234567890
CB41R 1234567890
 M 1234567890
CB44R
 1-2-3-4-5-6-7

PER: CORBIN (US)
FOR:

CB20
EMHART
CB102R
CB10
 2A 0-1-2-3-4-5-6-7-8-9
 7A 0-1-2-3-4-5-6-7-8-9
 8P 0-1-2-3-4-5-6-7-8-9
CB13 **CB13R**
CB14 **CB14R**
 BGM ...
 CAT ...
 1-200
 CHANGE-O-MATIC
 CCL

PER: CORNI
FOR:

CC5 1-1000
 48 1-1000
CC4 0-1-2-3-4-5-6-7-8-9
CC2 1-1000
 48 1-1000
 28001-29000
 80000-80625
 85000-86000
 86000-87000
 333 - BETA - CIC
CC3 **CC3R** 0-1-2-3-4-5-6-7-8-9
CC7 **CC7R** 0-1-2-3-4-5-6-7-8-9
CC6R 0-1-2-3-4-5-6-7-8-9
 BETA
 EURONORM
 BETA
 FONTAINE
 MUL.T.LOCK

PER: FOR:	CORNI	CORONA	COTICO
	<p>N 11 5 324</p>	<p>A 1112 5</p>	<p>OV 5</p>
	<p>CC1 CC1R CC8 1-2-3-4-5</p>	<p>COR1 COR2 COR2R</p>	<p>CO1 CO1R</p>
		BAB - BUG - DOCO GEBRO - ZEISS IKON	



63

- PER / FOR**
- CORNI (IT)**
+ CORBIN (60)
 - CORONA (DE)**
BAB
BUG
DOCO
GEBRO
ZEISS IKON
+ BAB (28)
+ ZEISS IKON (221)
 - COTICO (DE)**
 - COUILLET (FR)**
+ RICOUARD (160)
 - C.R. (IT)**
 - CRC-CAMBÔA (PT)**
+ CORBIN (60)
 - CRISTANI (IT)**
R.C.
 - CROWN (TW)**
 - CVL (ES)**
 - CWS (DE)**
+ DOM (68)

PER: FOR:	C.R.	CRISTANI	CROWN
	<p>OV 5</p>	<p>A 5 A 4</p>	<p>277 3</p>
	<p>C1 C1R</p>	<p>CT2 CT2R CT1 CT1R</p>	<p>CW1</p>
		R.C.	<p>mm 30</p>

PER: FOR:	CVL			
	<p>A 5</p>	<p>A 5 808</p>	<p>129 4</p>	<p>1214 S195</p>
	<p>CVL1 CVL1R</p>	<p>CVL3 CVL3R 1-2-3-4-5-6-7</p>	<p>CVL2 CVL2R</p>	<p>CVL5R IC 8-7-6-5-4-3</p>
		<p>CVL4</p>		



64

PER / FOR

DAC (GR)

DAD (FR)

DECAYEUX

+ FORT (90)

+ L & F (128-129)

+ RONIS (161)

+ VACHETTE (198-199)

DAF (TR)

DAIYA (TW)

DALWA (JP)

LIPS

DAMM (DE)

BKS (34)

DAV (FR)

RONIS (161)

DC (FR)

RONIS (161)

DE ANGELI (IT)

DEBEAURAIN (FR)

RONIS (161)

DECAYEUX (FR)

DAD (64)

DOM (69)

FORT (90)

O.NOVOX (150)

PICARDIE (155)

RICOUARD (160)

DEF (FR)

KIFERM (117)

DEFEND LOCK (CZ)

DEHA (TW)

YETI (218-219)

PER: FOR:	DAC	DAD		DAF	
		DECAYEUX			

PER: FOR:	DAF	DAIYA	DALWA	DE ANGELI

PER: FOR:	DEFEND LOCK		

PER:
FOR:

DEKABA

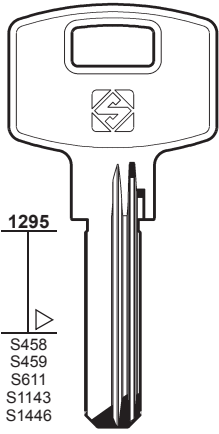

1295

S458
S459
S611
S1143
S1446



DK1

..... 00001-85798
..... 000001-028000



MAUER

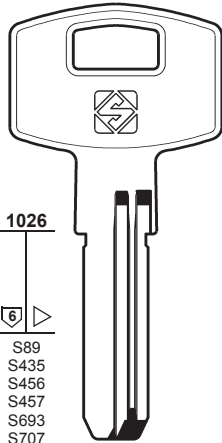

1026

6

S89
S435
S456
S457
S693
S707
S708
S1144 000016-280006



DK3

E2



DK6

E2

MAUER

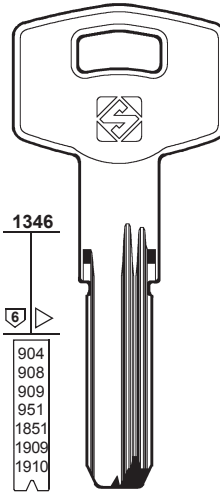

1346

6

904
908
909
951
1851
1909
1910



DK6X

..... 00016-280006



65

PER / FOR

DEKABA (BG)
MAUER
+ MAUER (132)

DELCA (GR)
GEVY

DELTA (FR)
RONIS (161)

DERLOCHE (FR)
RONIS (161)

DESPREZ (FR)
GABON (93)
RONIS (161)

DETHLEF (GB)
EURO-LOCKS (80)

DEXTER (IT)

PER:
FOR:

DEKABA

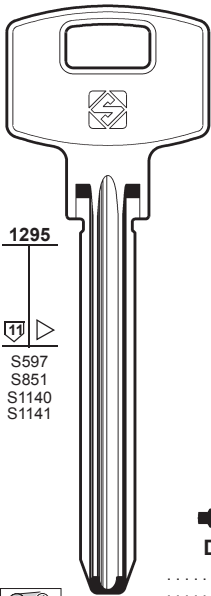

1295

17

S597
S851
S1140
S1141



DK7

..... 000002-111985
..... 000003-129307



MAUER

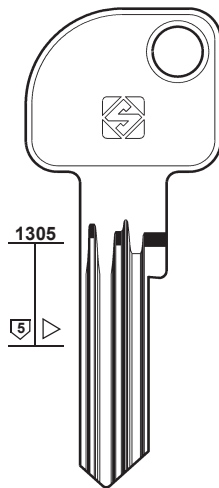

1305

5



DK5

F

MAUER

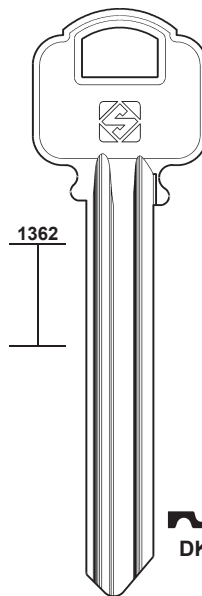

1362



DK4

MAUER

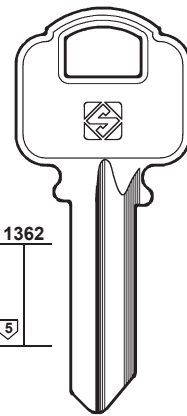

1362

5



DK8R



DK9R

PER:
FOR:

DELCA

DEXTER

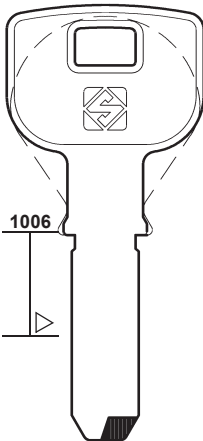

1006

DLC1

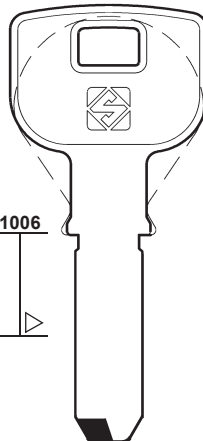

1006

DLC1R

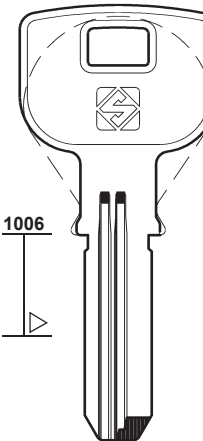

1006

DLC2R

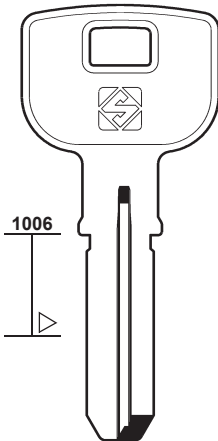

1006

DLC3

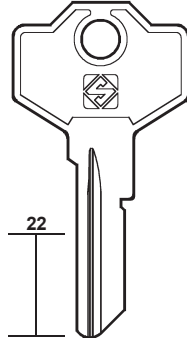

22

207

E.....
9001-9741

GS4R





66

PER / FOR

DEXTER (IT)

DIAMA (FR)

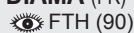

FTH (90)

DIAMOND (TW)

PER:
FOR:

DEXTER

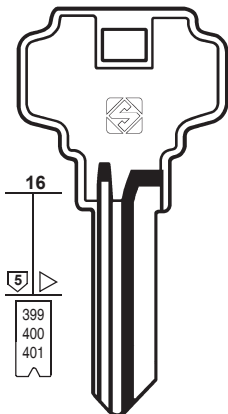

..... 0-1-2-3-4-5-6-7
..... 0-1-2-3-4-5-6-7
..... 0-1-2-3-4-5-6-7-8-9
..... T 0-1-2-3-4-5-6-7-8-9

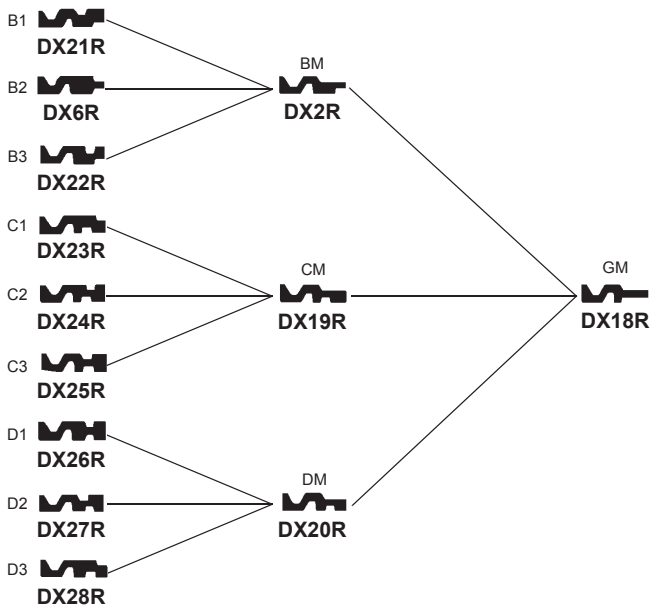

PER:
FOR:

DEXTER

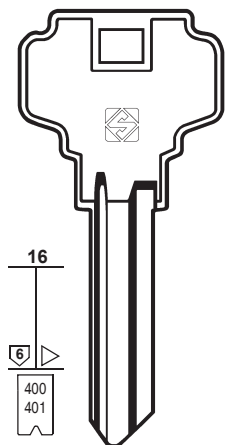

..... 0-1-2-3-4-5-6-7
..... 0-1-2-3-4-5-6-7-8-9
..... T 0-1-2-3-4-5-6-7-8-9

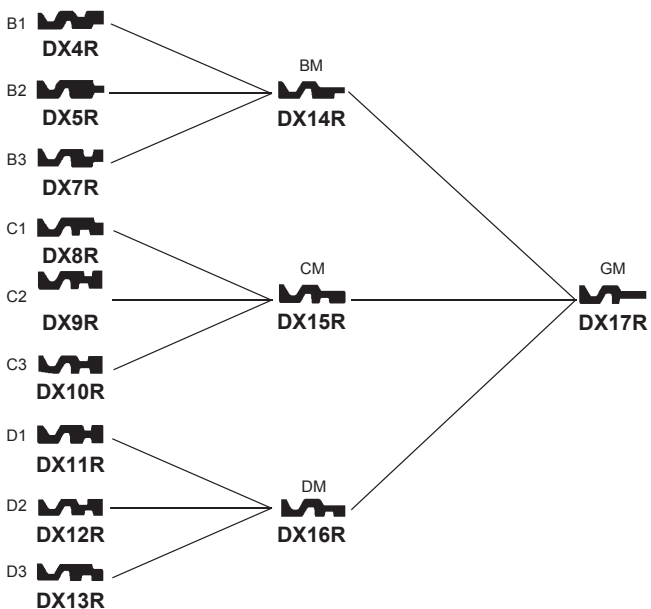

PER:
FOR:

DIAMOND

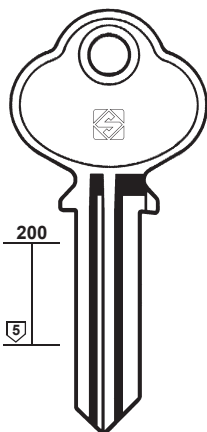

DN2

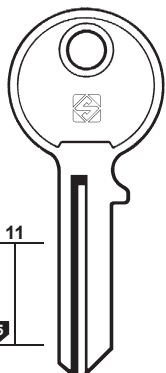

DN3



DN1

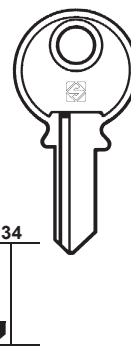

DN9R

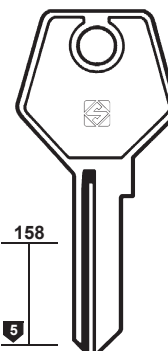

DN4



PER:
FOR:

DIAMOND

DIERRE

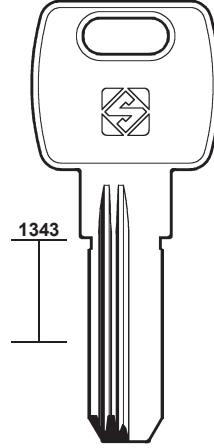
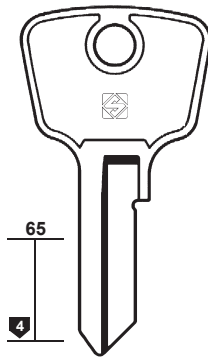
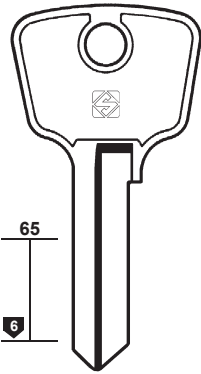
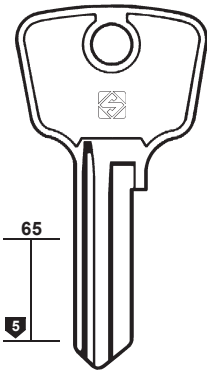
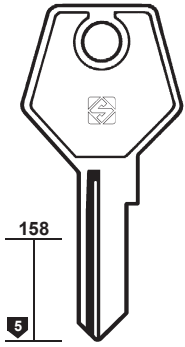

67



DN5



DN7



DN6



DN8



DIR1R



PER:
FOR:

DINBOX

DIMITROVGRAD

DLP (D. LA PORTE)

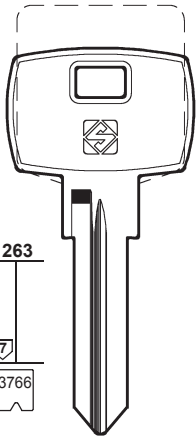

DBX1R

..... 1-2-3

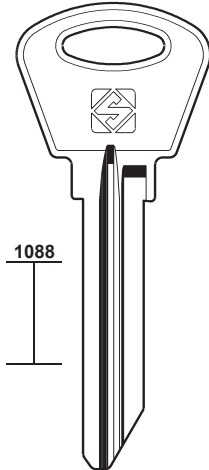

DMT1R

RUS3R

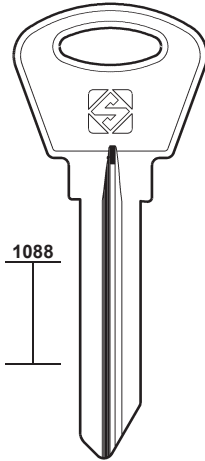

DMT2R

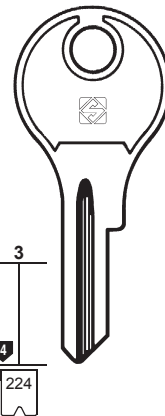

DL1R

..... 2501-2550

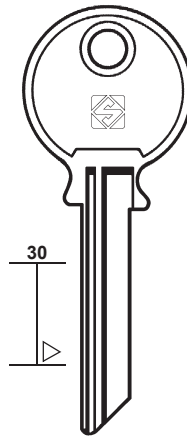

LAP3

3766

224



PER:
FOR:

DLP (D. LA PORTE)

DNEPROPETROVSK

DOBLINA

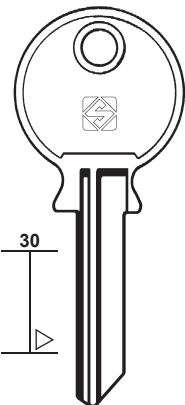

LAP2

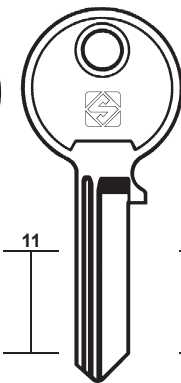

DL3

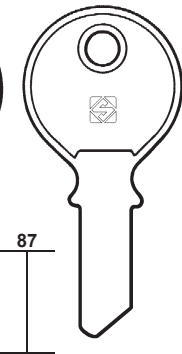

DL2

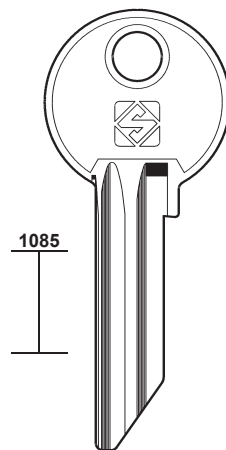

FMK1

FIMANEVSKI

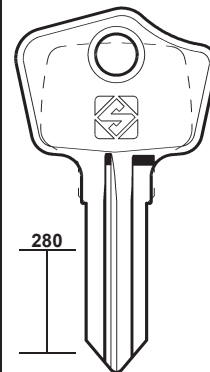

DB60

PER / FOR

DIAMOND (TW)

DIERRE (IT)
+ WILKA (210)

DIFA (DK)
+ RUKO (162)

DIMITROVGRAD (RU)

DINBOX (SE)

DISQUIN (FR)
+ TOK-WINKHAUS (185)

DLP (D. LA PORTE) (DE)
+ LA PORTE (121)

DNEPROPETROVSK (UA)
FIMANEVSKI

DNS (GB)
+ EAGLE (75)

DOBLINA (DE)



68

PER / FOR

DOBLINA (DE)

DOBUS (DE)

CISA (55)

DOCO (DE)

CORONA (63)

DOFIN (FR)

GLOBE (97)

DOM (DE)

BARRO

BTB

CHRIST

CWS

DECAYEUX

EAO

HÄFELE

HEKNA

HUWIL

IDEAL

MENOVA

METEOR

MLM

RUKA

SCHLEGEL

SINJET

STS

SWISSTAC

TM

+ CORBIN (60)

+ EMR (77)

+ MLM (141)

+ STUV (178)

PER:
FOR:

DOBLINA

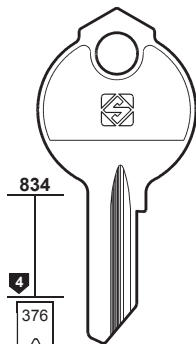

DB1 35 ...	DB1R 34 ...
DB2 U ...	DB2R V ...
DB3 2 ...	DB3R 1 ...
DB4 3 ...	DB4R 4 ...
DB5 6 ...	DB5R 5 ...
DB6 8 ...	DB6R 7 ...
DB7 11 ...	DB7R 12 ...
DB8 14 ...	DB8R 13 ...
DB9 15 ...	DB9R 16 ...
DB10 17 ...	DB10R 18 ...
DB11 20 ...	DB11R 21 ...

DB12 22 ...	DB12R 23 ...	DB28 120 ...	DB28R 121 ...	DB44 H ...	DB44R G ...
DB13 25 ...	DB13R 24 ...	DB29 122 ...	DB29R 123 ...	DB45 L ...	DB45R K ...
DB14 27 ...	DB14R 26 ...	DB30 125 ...	DB30R 124 ...	DB46 M ...	DB46R N ...
DB15 29 ...	DB15R 28 ...	DB31 130 ...	DB31R 131 ...	DB47 P ...	DB47R R ...
DB16 31 ...	DB16R 30 ...	DB32 132 ...	DB32R 133 ...	DB48 S ...	DB48R T ...
DB17 32 ...	DB17R 33 ...	DB33 134 ...	DB33R 135 ...	DB49 Y ...	DB49R Z ...
DB18 36 ...	DB18R 37 ...	DB34 136 ...	DB34R 137 ...	DB50 1Z ...	DB50R 1Y ...
DB19 39 ...	DB19R 38 ...	DB35 138 ...	DB35R 139 ...	DB51 1A ...	DB51R 1B ...
DB20 40 ...	DB20R 41 ...	DB36 141 ...	DB36R 140 ...	DB53 1E ...	DB53R 1F ...
DB21 42 ...	DB21R 43 ...	DB37 142 ...	DB37R 143 ...	DB54 1H ...	DB54R 1G ...
DB22 44 ...	DB22R 45 ...	DB38 145 ...	DB38R 144 ...	DB55 1K ...	DB55R 1L ...
DB23 47 ...	DB23R 46 ...	DB39 147 ...	DB39R 146 ...	DB56 1M ...	DB56R 1N ...
DB24 48 ...	DB24R 49 ...	DB40 148 ...	DB40R 149 ...	DB57 1R ...	DB57R 1P ...
DB25 51 ...	DB25R 50 ...	DB41 B ...	DB41R A ...	DB58 1T ...	DB58R 1S ...
DB26 53 ...	DB26R 52 ...	DB42 D ...	DB42R C ...	DB59 1X ...	DB59R 1W ...
DB27 54 ...	DB27R 55 ...	DB43 F ...	DB43R E ...		

PER:
FOR:

DOM

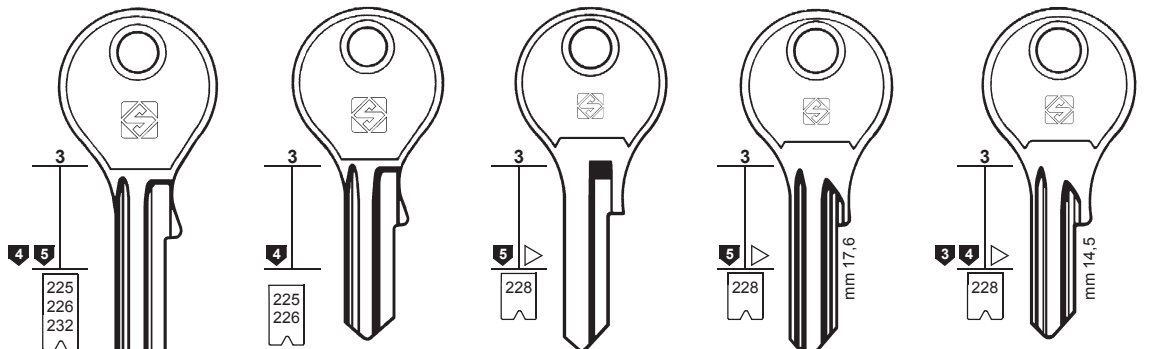

DM4 80138-80748 80761-83242 DN ... 1-120	DM4R 80138-80748 80761-83242 DN ... 1-120	DM6 80138-80748 80761-83242	DM39 6E ... 1-205 7E ... 269-473	DM39R 6E ... 1-205 7E ... 269-473	DM8 2D ... 1-222 5A ... 1-2600 9A ... 1-5200 W ... 1-50	DM8R 2D ... 1-222 5A ... 1-2600 9A ... 1-5200 W ... 1-50	DM10 2A ... 1-34 DB ... 1-148 CF ... 1-140 3A ... 1-82	DM10R 1D ... 58-114 2A ... 35-68
DM61 GS ... 1-1000 1-1000	DM61R GS ... 1-1000 1-1000	DM6R 80138-80748 GP ... 1-250 C ... 1001-1200 CL ... 1-250 C ... 1301-1500						



BARRO - IDEAL - TM

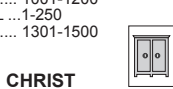

CHRIST



EAO - SWISSTAC

BTB - DECAYEUX
HÄFELE - HEKNA
HUWIL - METEOR
MLM - RUKA
SCHLEGEL - STS

CWS - HÄFELE
HEKNA - HUWIL
MENOVA - METEOR
MLM - RUKA
SINJET

PER:
FOR:

DOM

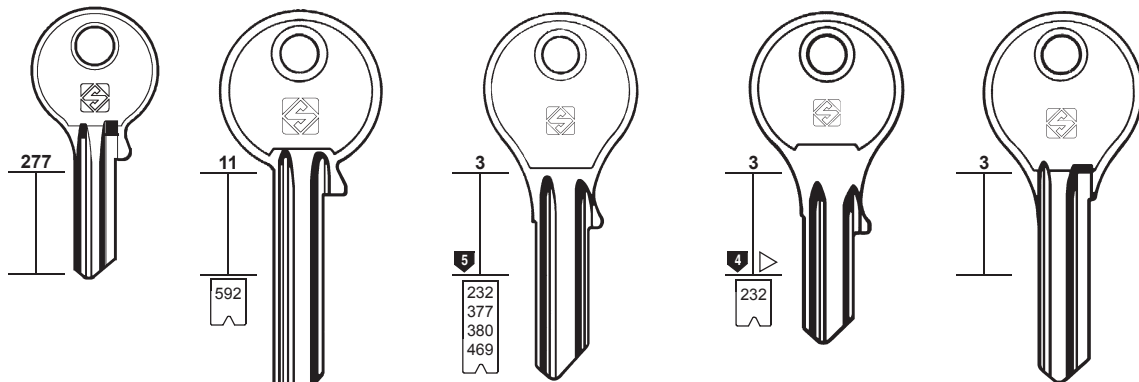

DM153

DM13
4 **DM13R**
3

DM2
3 **DM2R**
4
EV ... 1-2840
GS ... 1-1000
FT ... 1-1000
CQ ... 301-400
... 1-1000

DM23
29 **DM23R**
3
CL ... 501-750
ED ... 1-380
EG ... 1-250

DM5 **DM5R**

DM96 **DM104R**
1E ... 1-160 **KNK**

DM62 **DM62R**

NOBO

LISTA

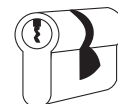

69

PER / FOR

DOM (DE)

FLAMBO
GEWIRU
HEKNA
LISTA
NOBO
PEROHAUS
RAFI

- + CORBIN (60)
- + EMR (77)
- + MLM (141)
- + STUV (178)

PER:
FOR:

DOM

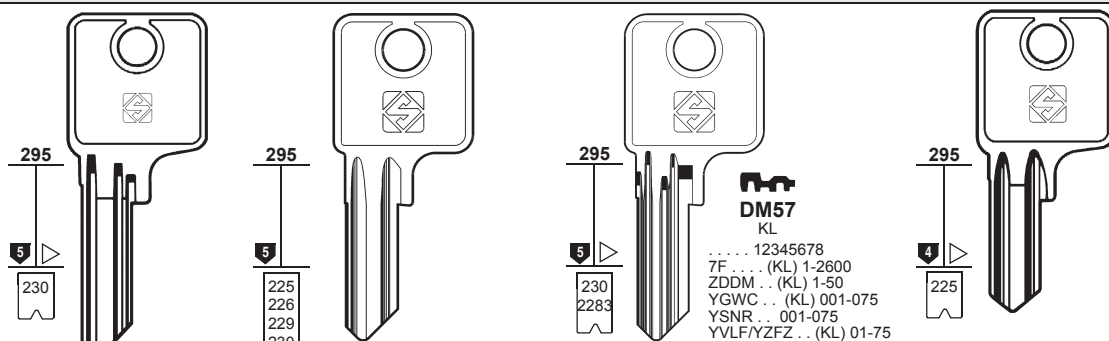

DM41 **DM41R**

DM38 **DM52**

DM101

DM16 **DM16R**
DC ... 1-1800
K ... 1-50
GD ... 1-1800
GZ ... 1-1800
3E ... 1-350
2C ... 1-2600

DM19 **DM19R**
DN ... 1-120
... 80138-80748
... 80761-83242

FLAMBO - HEKNA
NOBO - PEROHAUS

DM111 **DM112**
VN ... (KL) 1-2600
ZDDM ... (KL) 1-50
YGNW ... (KL) 001-075
YSNR ... 001-075
YVLF/YZFY ... (KL) 01-75

DM113 **DM137**
WL ... (WL) 2701-2775
YZFY ... (WL) 2701-2775

DM102 **DM112**
WS ... (WS) 2701-2775
YZFY ... (WS) 2701-2775

DM149

DM37 **DM37R**

DM36 **DM36R**

C ... 1001-1200
CL ... 1-250
GP ... 1-250
C ... 1301-1500

GEWIRU

PER:
FOR:

DOM

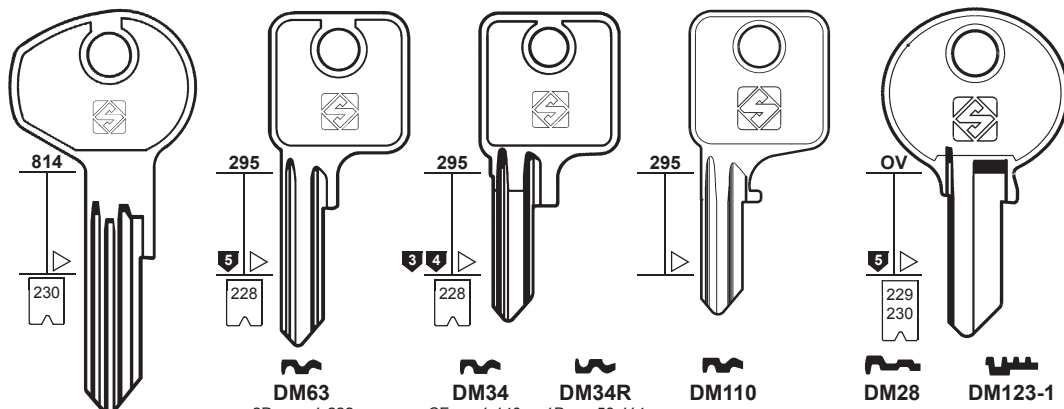

ZDDM ... 101-150
7F ... (KN)
1F ... 501-513
YSNR ... 201-275
YVLF ... (KN) 201-275
YZFY ... (KN) 201-275

DM106

DM63
2D ... 1-222
5A ... 1-2600
9A ... 1-5200
W ... 1-50

DM63R

DM34 **DM34R**
CF ... 1-140
DB ... 1-148
2A ... 1-34
4A ... 1-482
1D ... 1-57
FG ... 1-615
3A ... 1-82
1D ... 501-560

RAFI

DM110

BMW

DM28

DM11
2C ... 1-2600
DC ... 1-1800
3E ... 1-350
GD ... 1-1800
GZ ... 1-1800
1C ... 1-363
TB ... 1-1796
YSNR ... (VN) 1201-1275
YSNR ... (WN) 2201-2275
YZFY ... (VN) 1201-1275

DM123-1

DM123-2

DM123-3

DM123-4

DM123-5

DM123-6

DM123-7

DM123-8

DM123-9

DM123-10



70

PER / FOR

- DOM (DE)
- CORBIN
- DYES
- EMHART
- FORTSCHRITT
- HÄFELE
- HÖHRMANN
- LISTA
- MAQUET
- MARCO
- MIPPART
- MLM
- STEIGA
- STUV
- VARIO
- VIKI
- VOKO
- + CORBIN (60)
- + EMR (77)
- + MLM (141)
- + STUV (178)

PER:
FOR:

DOM

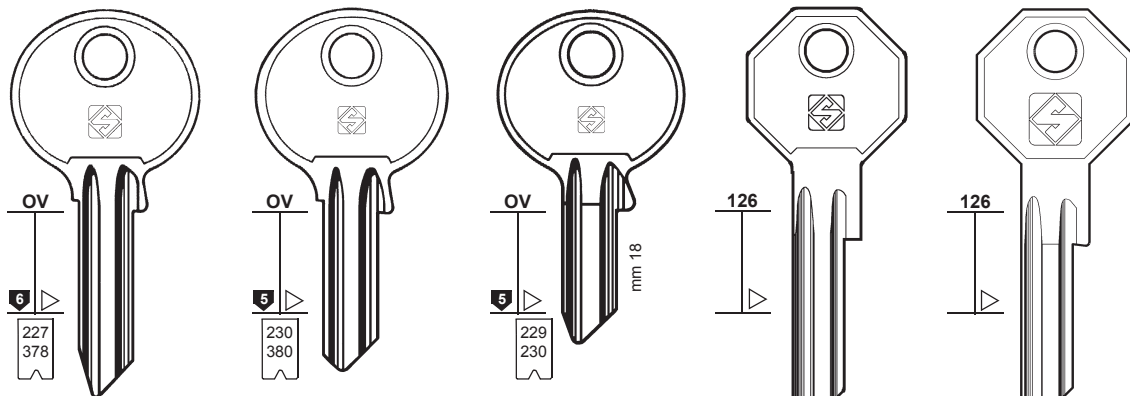

- DM7 DM35R FA... 1-3948 CD... 1-500
- DM25 EV... 1-2840 4C... 1-3000
- DM48 2C... 1-2600 DC... 1-1800 3E... 1-350 GD... 1-1800 GZ... 1-1800
- DM155 DM116

VARIO HÖHRMANN DYES - FORTSCHRITT - HÄFELE LISTA - MAQUET - MARCO MIPPART - MLM - VOKO

PER:
FOR:

DOM

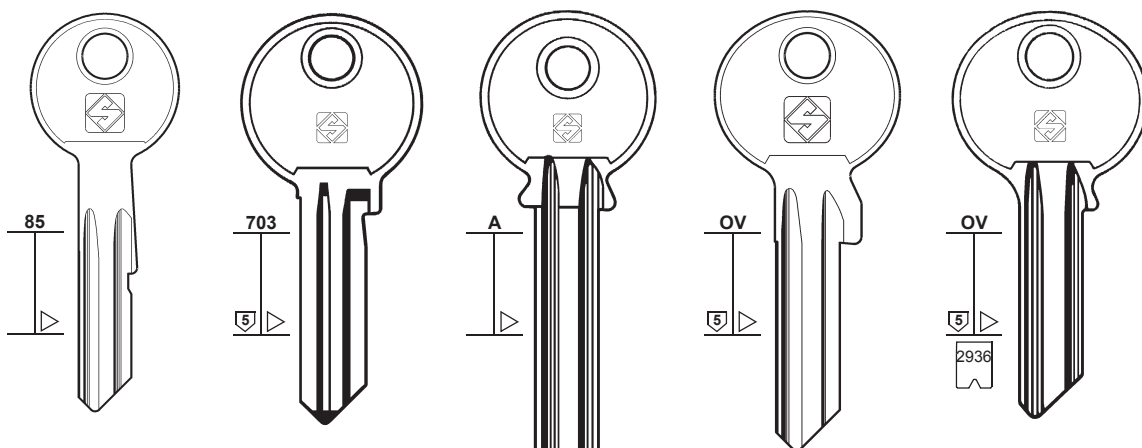

- DM114 DM98R E DM32 DM3X DM3 DM105R

STEIGA STUV - VIKI

PER:
FOR:

DOM

- DM154 DM154R DM22TVP
- DM152 DM22TV5 DM22TV10
- DM151R DM22TV4 DM22TV9
- DM141R DM22TV3 DM22TV8
- DM132 DM132R DM22TV2 DM22TV7
- DM20 DM97R DM103 DM22 DM22TV1 DM22TV6
- DM14 DM119 CORBIN DM22

..... PT 129893-130092
0-1-2-3-4-5-6-7-8-9 PT 129893-130092
..... PT 0123456789 0123456789

CORBIN - EMHART

PER:
FOR:

DOM



71

PER / FOR

DOM (DE)
ASPA
CORBIN
EMHART
IR
LAPERCHE
MOREAUX
NOBO
STS

- + CORBIN (60)
- + EMR (77)
- + MLM (141)
- + STUV (178)

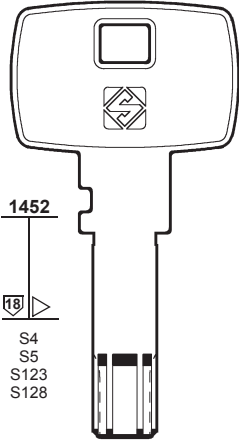

1452

18

S4
S5
S123
S128

DM22TVPX **DM22TV5X**

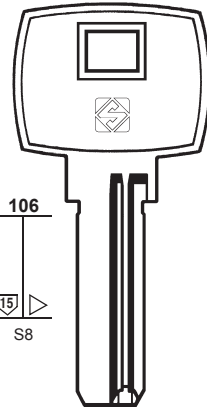

106

15

S8

DM24 **DM64**
IX5

DM118

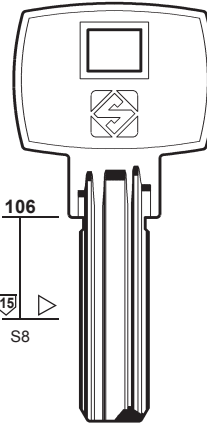

106

15

S8

DM120 **DM122**



PER:
FOR:

DOM

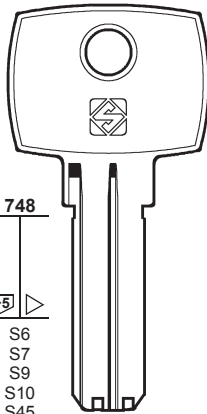

748

5+5

S6
S7
S9
S10
S45
S118
S178

DM49 **DM53**

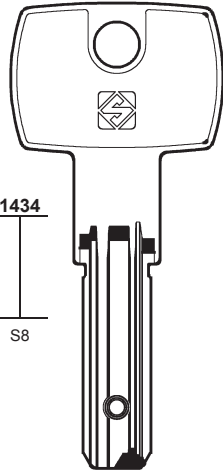

1434

S8

DM139 **DM145**
IX5

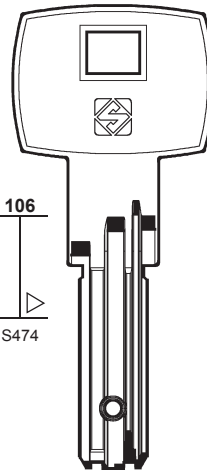

106

S474

DM144
IX6



PER:
FOR:

DOM

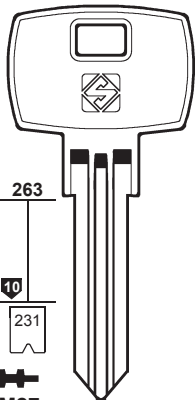

263

10

231

DM27
1H 1-4088
3H 1-600

DM17 **DM17R**

1H 1-4088
2H 1-2088
3H 1-600
ASPA

NOBO

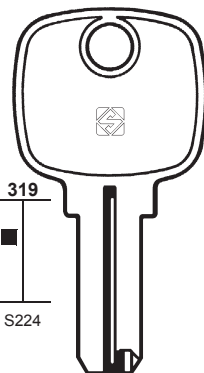

319

S224

DM21
..... 0-1-2-3-4-5

MOREAUX

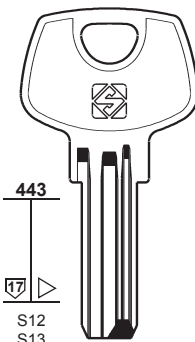

443

17

S12
S13

DM138

DM55
2Y

ALARM

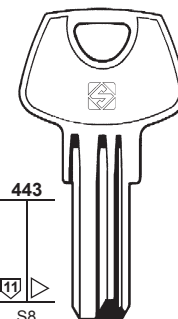

443

11

S8
S11

DM128

DM58

ALARM



72

PER / FOR

DOM (DE)

PER:
FOR:

DOM

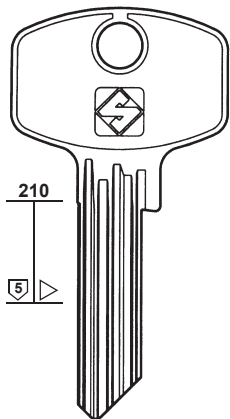

PER:
FOR:

DOM









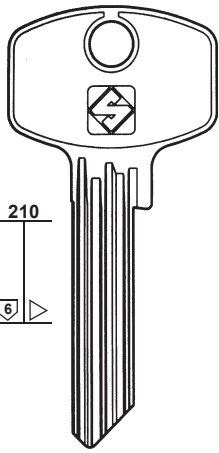



































73

PER / FOR

DOM (DE)



 DM86 L	 DM86R L	 DM77	 DM77R	 DM76	 DM76R
 DM87 M	 DM87R M			 DM78	 DM78R
 DM88 C	 DM88R C	 DM108	 DM108R	 DM79	 DM79R
 DM89 D	 DM89R D			 DM80	 DM80R
 DM90 P	 DM90R P			 DM84	 DM84R
	 DM94R U			 DM109	 DM109R

 DM91 Q	 DM91R Q	 DM81	 DM81R	 DM95 T	 DM95R T
 DM92 R	 DM92R R	 DM82	 DM82R		
 DM93 S	 DM93R S	 DM83	 DM83R		
		 DM85	 DM85R		

 DM65-00	 DM65-1	 DM65-10	 DM65-19	 DM65-28	 DM65R-12	 DM65-46
	 DM65-2	 DM65-11	 DM65-20	 DM65-29	 DM65R-13	
 DM65R-00	 DM65-3	 DM65-12	 DM65-21	 DM65-30	 DM65R-16	
	 DM65-4	 DM65-13	 DM65-22	 DM65-31	 DM65R-19	 DM65-40
	 DM65-5	 DM65-14	 DM65-23	 DM65-32	 DM65R-31	 DM65-41
	 DM65-6	 DM65-15	 DM65-24	 DM65-33	 DM65R-32	 DM65-42
	 DM65-7	 DM65-16	 DM65-25	 DM65-34	 DM65R-34	 DM65-43
	 DM65-8	 DM65-17	 DM65-26	 DM65-35	 DM65R-35	 DM65-44
	 DM65-9	 DM65-18	 DM65-27	 DM65-36	 DM65R-36	 DM65-45



74

PER / FOR

DOMINION (US)
PETERBORO
+ ARROW (20)

DOMUS (IT)
+ CAS-CISMA (45)

DOMUS (GR)

PER:
FOR:

DOMINION

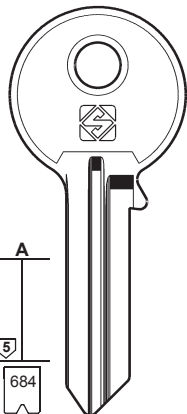

DO1R

1-2-3-4-5-6-7-8-9

PETERBORO

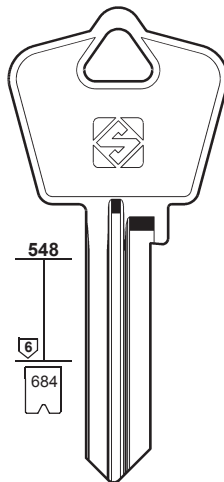

DO2R

1-2-3-4-5-6-7-8-9

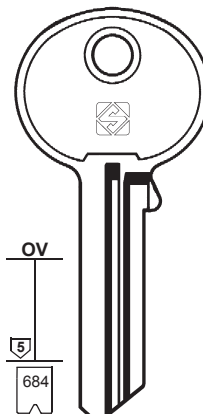

DO6

1-2-3-4-5-6-7-8-9

PER:
FOR:

DOMINION

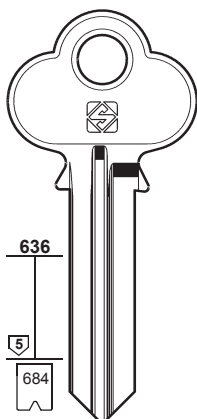

DO10

1-2-3-4-5-6-7-8-9

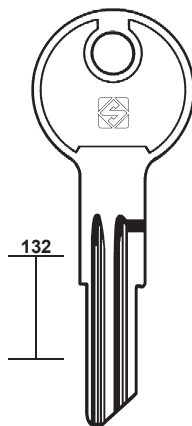

DO11

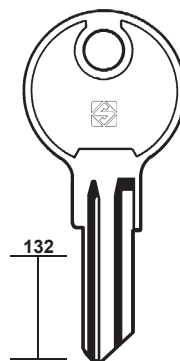

DO12

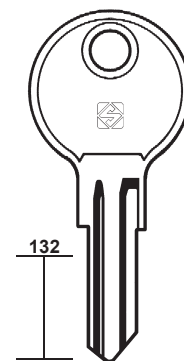

DO13



PER:
FOR:

DOMUS (IT)

DOMUS (GR)

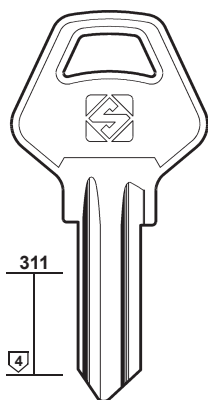

DS4

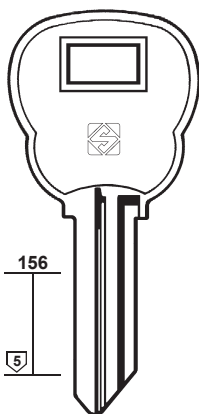

DS1



DS1R



DS2

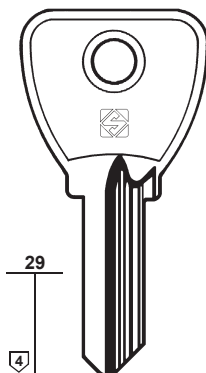

DS3R

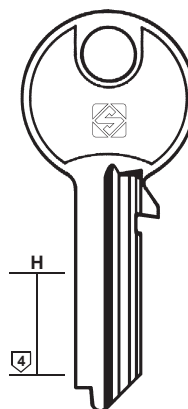

DS5R

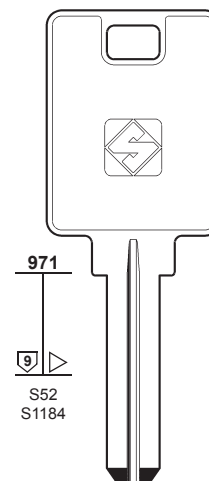

DS6



DS7

S52
S1184



PER: FOR:	DONG HWA	DORIC	DORSET	DOUBLE ARROWS
--------------	----------	-------	--------	---------------

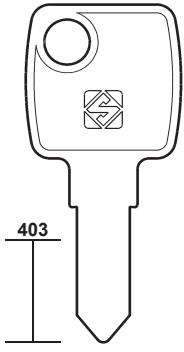

DOW1R

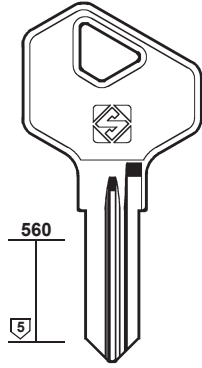

DRC1

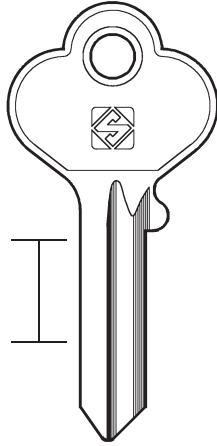

DRS1R

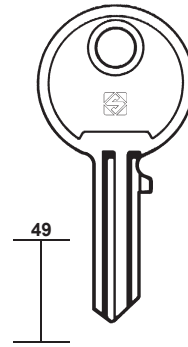

DW1



75

PER / FOR

DONG HWA (TW)

DORIC (AU)

DORMA (DE)
 WILKA (210)

DORSET (IN)
 KABA (113)

DOUBLE ARROWS (TW)

DOUBLE CIRCLE (TW)
 TRI-CIRCLE

DOUBLE SAFE (GB)
 EURO LOCKS (79)
 L & F (128)

DUBOIS (FR)
 LAS (121)

DUO (US)
 ILLINOIS (107)

DIPLOMATIC (IT)

DYES (DE)
 DOM (70)

EAG (DE)

EAGLE (US)
 DNS
 HARLOC
 LORI

EAO (DE)
 DOM (68)

EAST (TW)

EBA (IT)
 MERONI (137)

ECM (PT)

**PER:
FOR:** **DOUBLE CIRCLE**

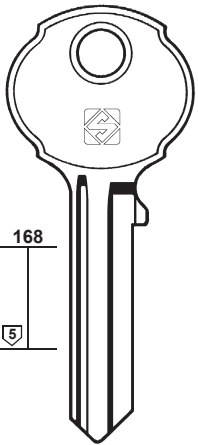

DCR1

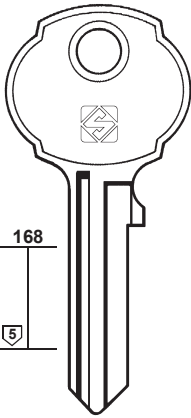

DCR2

TRI-CIRCLE

DIPLOMATIC

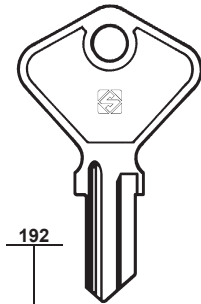

DP1 DP1R

EAG

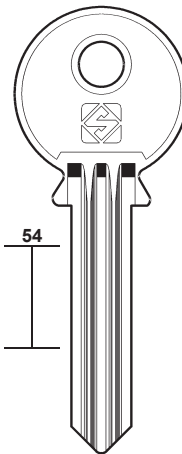

EA1

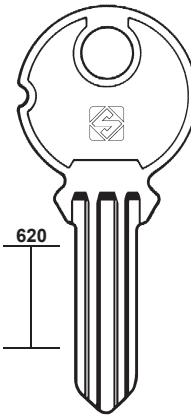

EA2

EA3

EA4

**PER:
FOR:** **EAGLE**

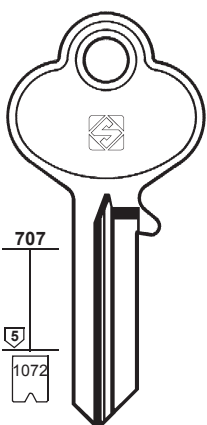

EG1

.....
 1-2-3-4-5-6-7-8-9-0

DNS - HARLOC - LORI

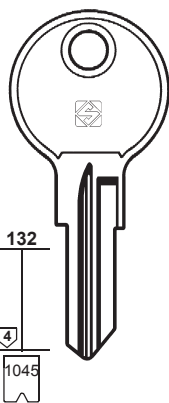

EG2

EG2R
 1A...
 EA...
 EB...
 EZ...
 PZ...
 1-240

EAST

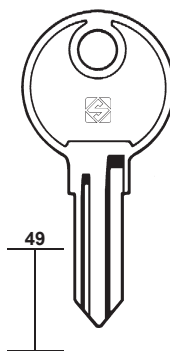

EAS1

ECM

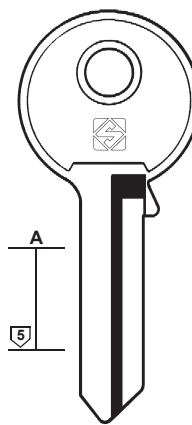

ECM1

ECM1R



76

PER / FOR

EFCO (AU)

EGRET (GR)

EFSA (FR)

BABY-CLIP (30)

EGSA (DE)

TOK-WINKHAUS (186-187)

EIKO (TW)

CINA (54)

EKLA (HK)

GUARD (100)

ELCA (DE)

STS
TESA
VIRO

ELDON (DE)

EMKA (77)

ELEPHANT (TW)

TRI-CIRCLE (189)

ELFIN (IT)

CEMA (46)

ELKO (CZ)

ELMO (US)

BASCO (31)

ELP (RU)

ELSA (IT)

GIUSSANI (96)

ELSET (FR)

CLAUSOR (59)

ELSI (IT)

INDESIT (107)

ELVOX (IT)

GIUSSANI (96)

ELZETT (HU)

TIEFENTHAL

+ **CES** (47)

EMGE (FR)

RONIS (161)

EMHART (US)

CORBIN (62)

DOM (70-71)

RONIS (161)

PER: **EFCO**

FOR:

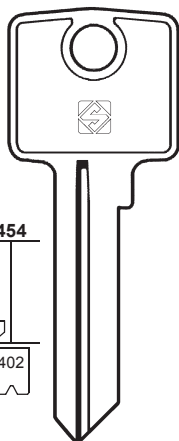

454

6

402

0-1-2-3-4-5-6-7-8-9



EF7

CA

EF1R

CK

EF2R

DA

EF3R

DB

EF4R

DK

EF5R

DM

EF6R

PER: **EGRET**

FOR:

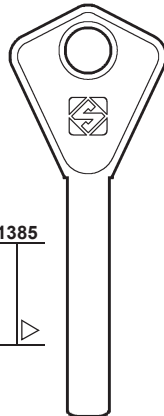

1385



EGR1

PER: **ELCA**

FOR:

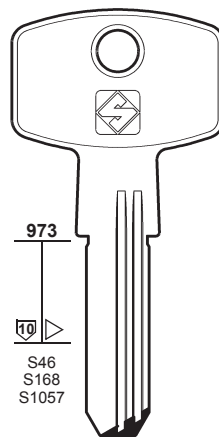

973

10

S46
S168
S1057



EC5



STS - TESA - VIRO

PER: **ELKO**

FOR:

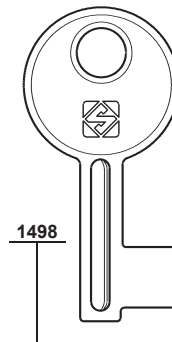

1498



ELK1

PER: **ELP**

FOR:

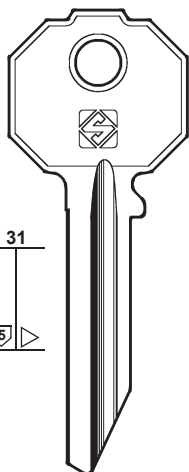

31

5



ELP1R

PER: **ELZETT**

FOR:

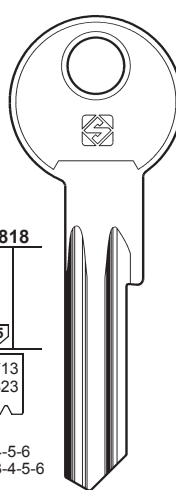

818

5

713
823

1-2-3-4-5-6
0-1-2-3-4-5-6



EL1X



TUTIS

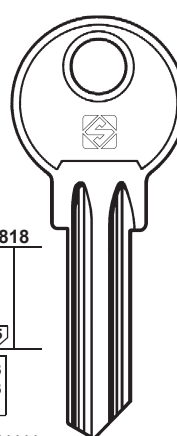

818

5

713
823

1-2-3-4-5-6
0-1-2-3-4-5-6



EL1



TIEFENTHAL

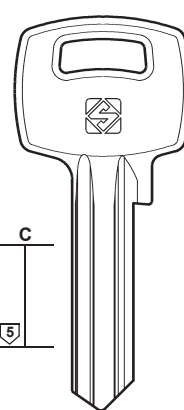

C

5



EL1C

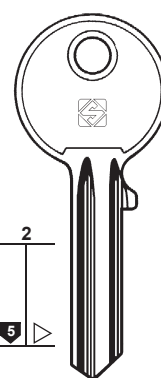

2

5



EL3

PER: **ELZETT**

FOR:

PER: **ELZETT**

FOR:

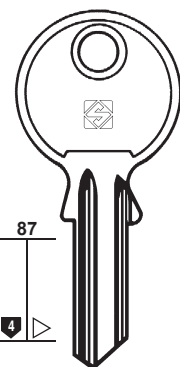

87

4



EL2

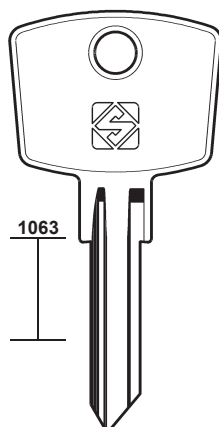

1063



EL4



EL5R



EL6



EL7R

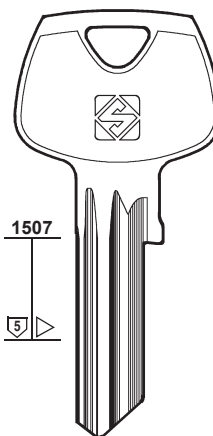

1507

5



EL10

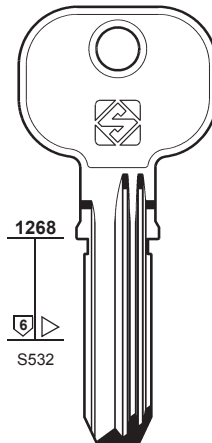

1268

6

S532

0-1-2-3-4



EL9



PER:
FOR:

EMKA

EMR

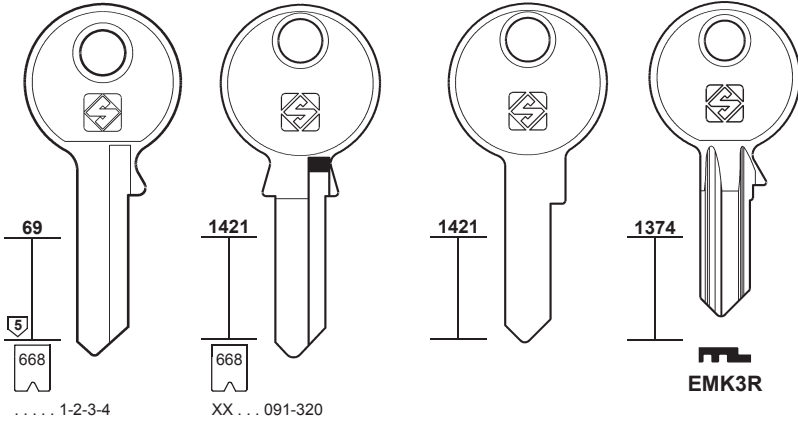

..... 1-2-3-4
XX ... 091-320

EMK1

EMK5

EMK6R

EMK3R

EMK2

EMK13

ELDON - GHE
KOVER - RONIS

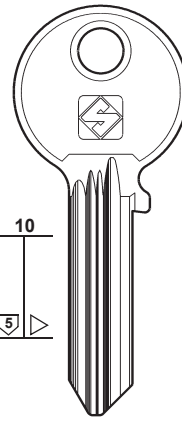

EM1

EM1R

EM2R

EM3R

EM4

EM3

DOM - GTV - JOWIL
TIEFENTHAL



77

PER / FOR

- EMKA (FR)
- ELDON
- GHE
- KOVER
- RONIS
- + EURO LOCKS (78)
- + FORT (90)
- + RONIS (161)
- + TITAN (183)
- + WILKA (210)

PER:
FOR:

EMR

ENEL

ERA

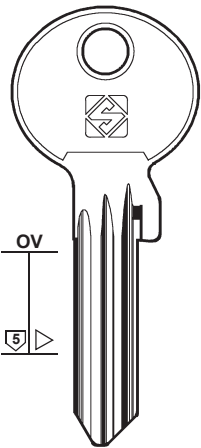

EM11

GTV - JOWIL

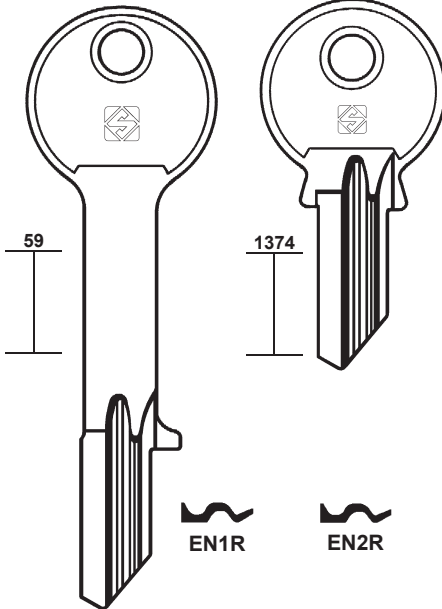

EN1R

EN2R

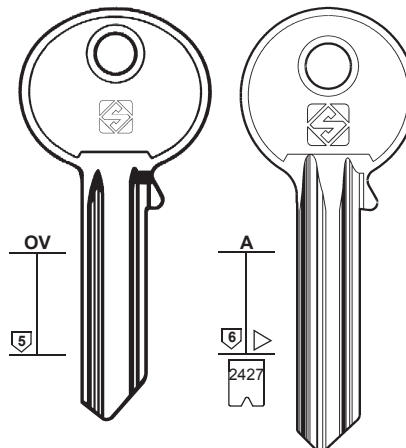

ER1

ER2

.....
1-2-3-4-5-6-7-8-9

- EMR (DE)
- DOM
- GTV
- JOWIL
- TIEFENTHAL

- ENAX (FR)
- TOK-WINKHAUS (187)

ENEL (IT)

- EPO (JP)
- SCHLAGE (165)

- EQUIBATIR (FR)
- RONIS (161)

ERA (GB)

- ERICSSON (SE)
- TEKA (181)

- ERMEX (SE)
- TEKA (181)

ERTEL (DE)

- ESA (ES)
- NUMIDIA

PER:
FOR:

ERA

ERTEL

ESA

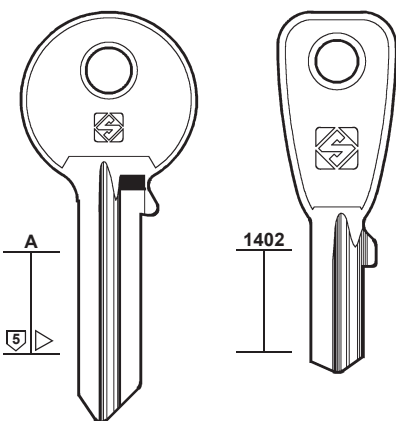

ER3R

ER4R

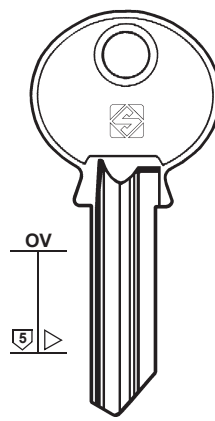

ERT1

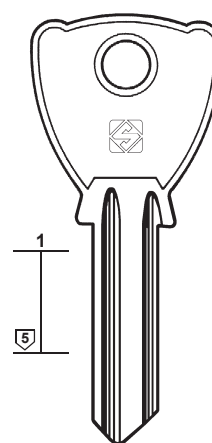

ES1R

ES1

NUMIDIA

- ESAFE (ES)
- EZCURRA (82)
- TESA (181)
- UCEM (192)

- ESCO (DE)
- CISA (55)
- CORBIN (60)

- ESLA (GB)
- CISA (56)

- ESS (DE)
- BAB (28)

- ESSENDIA (SE)
- CISA (55)

- ESZ (DE)
- JOWIL (110)



78

PER / FOR

ETAS (GB)
YANEDIS

ETF (FR)
+ BABY CLIP (30)

ETNA (IT)
+ CAS-CISMA (45)

EUREKA (IT)
ITALBLOCK

EUROBOX (GB)
+ FORT (90)

EURO LOCKS (BE)
FASMA
L & F
SCHULTZ
+ BASTA (31)
+ CHICAGO (52)
+ L & F (128-129)

PER: FOR:	ETAS	ETF	ETNA
	 YANEDIS		 ET1R ET2R

PER: FOR:	EUREKA				EUROBOX
	 EK1	 EK1R	 EK2	 EK2R	 EK4
	 EK3	 EK3R	 EK4	 EK4R	 EKBX1R
	ITALBLOCK				

PER: FOR:	EURO LOCKS		
	S928 S990 EU17	200 1435 EU3 EU11R 2151-2949 K..... 5272-6291	 EU12 EU1R 1201-1400 45001-48000 45001-49001 43001-45000 48001-49000 50001-52000 EU19 EU5R 25001-27000 FASMA EU18R
	SCHULTZ		L & F

PER:
FOR:

EURO LOCKS

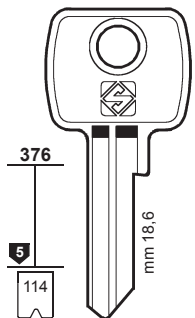

LF4

60 ... 1-400
90 ... 1-200
92 ... 1-400
... 1-400
GHM ... 1-155
M ... 1-400
92 ... 401-600
99 ... 1-400
RV ... 1-400
RVM ... 1-400
SP ... 1-400
GS ... 1-400
... ES1
... EV1



LF4R

99 ... 401-600
92 ... 501-700

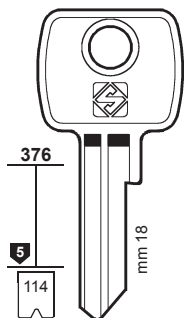

LF6



LF18R



LF6R

90 ... 1-200
... 1-400
91 ... 201-275
GH ... 1-400
SS ... 1-400
91 ... 276-350

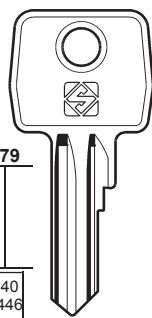

EU4

... E 01234
... E 1111-4444
... 405-4324
... E 405-4324



EU2



EU7



EU4R

... A 01234
... A 1111-4444
... 458-5124



EU2R

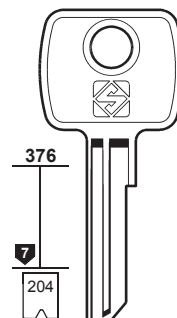

LF11

76 ...
1-400
...
70001-71000



LF11R

M ...
70001-71000

L & F

L & F

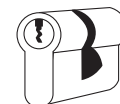

79

PER / FOR

EURO LOCKS (BE)

- DOUBLE SAFE
- BASI
- IBFM
- L & F
- VIOMETAL
- + BASTA (31)
- + CHICAGO (52)
- + L & F (128-129)

PER:
FOR:

EURO LOCKS

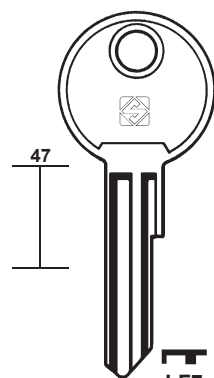

LF7



LF8



LF8R

L & F

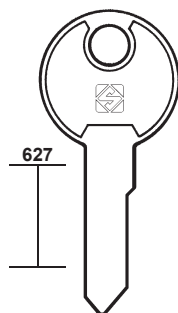

LF29R

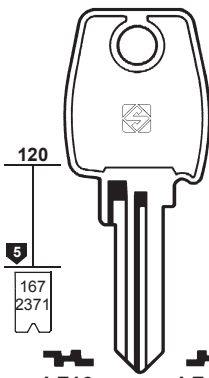

LF16



LF16R



LF2

G ... 1001-5000
... 31001-32000
... 32001-33000
... 36001-38000
... 38001-38999
... 77001-77500
... 95000-99000



LF26

77001-77500
95000-99000

DOUBLE SAFE

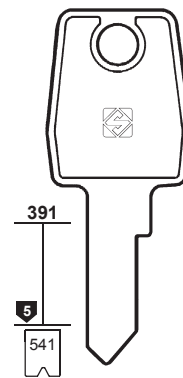

LF13



LF17



LF15R

90901-90975

L & F

PER:
FOR:

EURO LOCKS

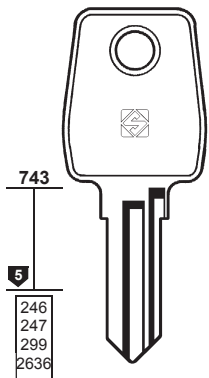

LF22

93 ... 201-400
... 93901-94000



LF22R

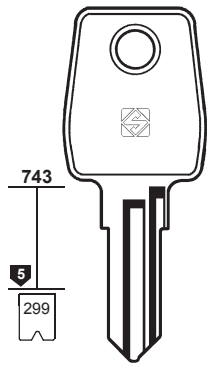

LF20

93901-94000



LF20R

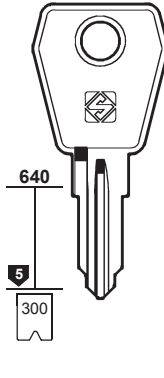

LF30R

... 801-900
... 901-1000
... 901-1000
IBFM



EU9

BASI - L & F
VIOMETAL



EU16R

L & F

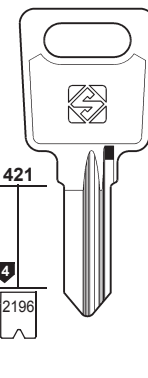

EU14

IF ... 1-2-3-4



80

PER / FOR

EURO LOCKS (BE)

DETHLEF
HOBBY
KNAUS
TRABER
+ * BASTA (31)
+ * CHICAGO (52)
+ * L & F (128-129)

EURONORM (DE)

* CORBIN (60)
* CORNI (62)

EUROP (FR)

* SUREX (178)

EURO PLUS (CZ)

EUROSPEC (GB)

EVERGOOD (TW)

JNF
MERONI
SISO

EVO (GB)

MILA

EVVA (AT)

TRYBA

PER: FOR:	EURO LOCKS	EURO PLUS	EUROSPEC	EVERGOOD
	 3 55 2196 298 3982 EU20 12345 EU15 EU6 EU10 EU10R 2001-2200 DETHLEF - HOBBY KNAUS - TRABER	 1241 EUR1	 1329 2690 EUS1 123456	 625 ED1

PER: FOR:	EVERGOOD	EVO	EVVA
	 48 3344 ED2 MERONI 1-2-3 ED4 ED3R JNF - SISO	 A EVO1 MILA	 54 360 441 666 1537 A 1000-9999 A . 1000-9999 A . 1000-9999 A ... 1000-9999 1234567890 1234567890 XA 40000-59999 A 5600-9999 60001-97000 C 1000-9999 C . 1000-9999 C . . 1000-9999 C ... 1000-9999 (.) 1234567890 C ... 5600-9999 C 60001-97000 EV2 E EV3 C EV4 F EV5 Z EV9 BB EV10 A EV3R 2C EV4R 2F Z 1000-9999 Z . 1000-9999 Z . . 1000-9999 Z ... 1000-9999 Z 5600-9999 F 1000-9999 F . 1000-9999 F . . 1000-9999 F ... 1000-9999 F 5600-9999

PER: FOR:	EVVA			
	 54 666 EV110RX EV118X EV3X C EV4X F EV5X Z EV2X E EV69X S EV111RX EV3RX 2C EV4RX 2F EV9X BB EV10X1 A EV64RX S	 OV 666 EV10X A 60001-97000	 471 666 EV11 C EV12 A	 54 361 666 EV81X 6S 40000-59999 EV109X EV82X

TRYBA

PER:
FOR:

EVVA

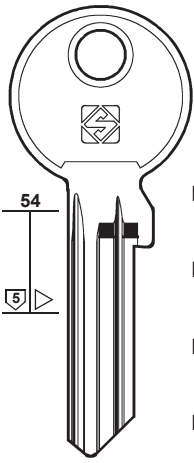

EV103X-1

EV103X-2

EV103X-3

EV103X-4

EV103X-5

EV103X-6

EV103X-7

EV103X-8

EV103X-9

EV103X-10

EV103X-11

EV103X-12

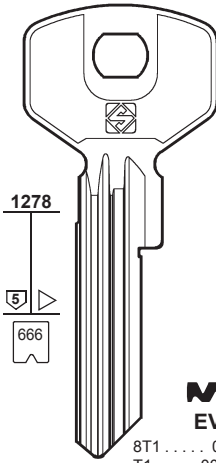

EV70

8T1 00000-99999
T1 00001-68199
T1 68200-99999

EV70R

OT1 00000-99999
OT 00001-83799
OT 83800-99999

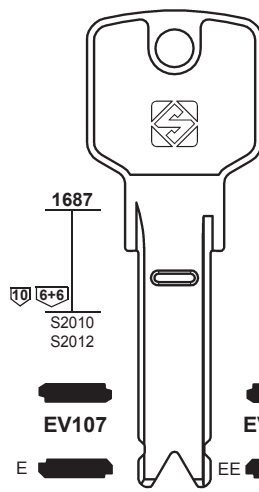

EV107

EV106

EV122

EV107R

EV106R

EV122R

S2010
S2012



81

PER / FOR

EVVA (AT)

EXCEL (FR)
+ SIDLEEN (169)

EXPRES (PL)
+ LOB (125)

EXCEL (FR)
+ SIDLEEN (169)

EXPRES (PL)
+ LOB (126)

EZCURRA (ES)
+ SEA (166)

PER:
FOR:

EVVA

EXCEL

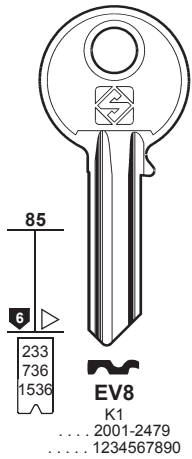

EV8

K1
..... 2001-2479
..... 1234567890

EV8R

K0
..... 1001-1479
..... 1234567890

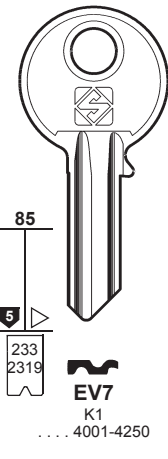

EV7

K1
..... 4001-4250

EV7R

K0
..... 3001-3250
M 3001-3250

EV21R
NM
NM2
50000-54999

EV22R
NM
NM2
55000-59999

EV23R
NM
NM2
60000-64999

EV24R
NM
NM2
65000-59999

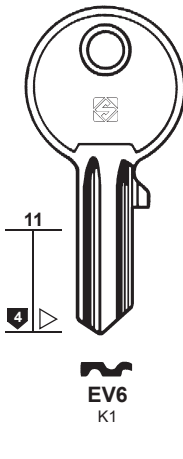

EV6

K1

EV6R

K0

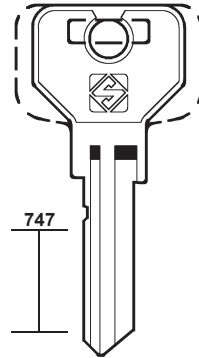

EX1

PER:
FOR:

EZCURRA

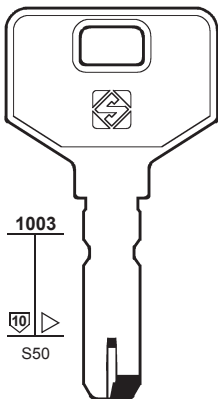

EZ3
DS10

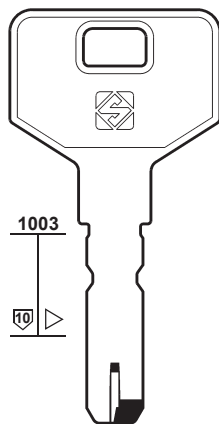

EZ3X
DS10

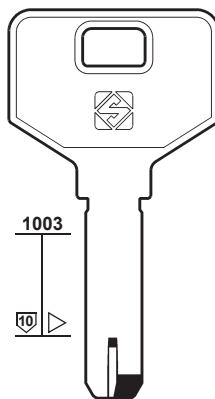

EZ6
DS15

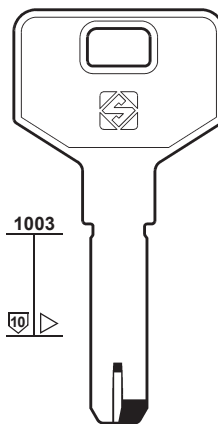

EZ6X
DS15





82

PER / FOR

EZCURRA (ES)

ESAFE
JMR
NAZABAL
+ SEA (166)

E-Z-SET (US)

KWIKSET (119)

FAB (CZ)

GUARD
LOB
YETI

PER:
FOR:

EZCURRA

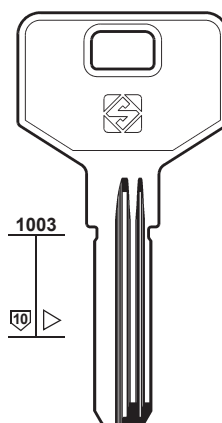
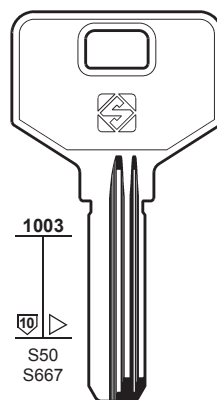
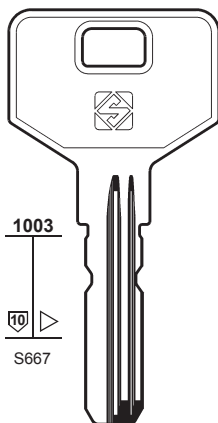
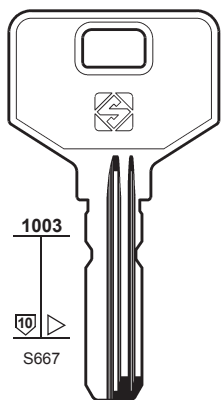

PER:
FOR:

EZCURRA

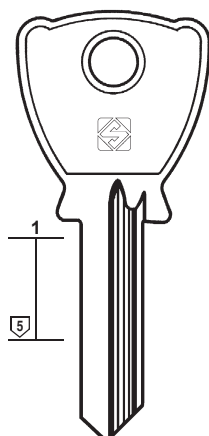

NAZABAL

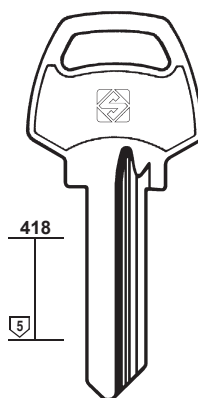

ESAFE - JMR

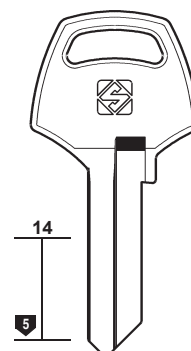

PER:
FOR:

FAB

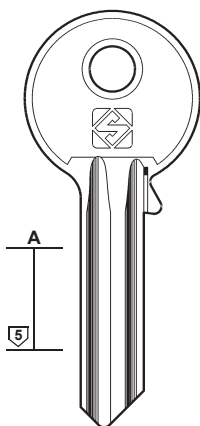

GUARD

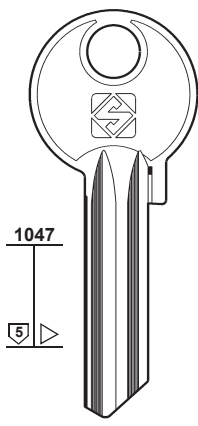

GUARD

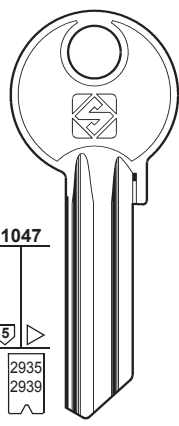

LOB - YETI

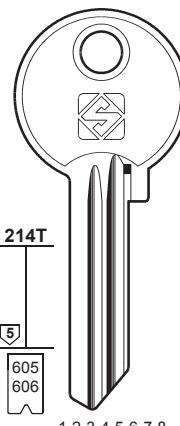

15



..... 1-2-3-4-5-6-7-8
..... 0-1-2-3-4-5-6-7-8



16

PER:
FOR:

FAB

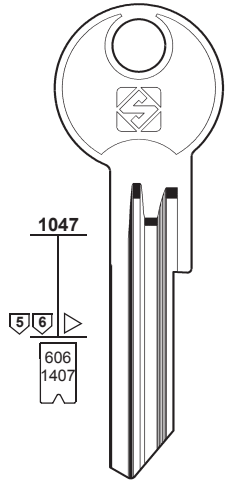

..... 0-1-2-3-4-5-6-7-8
..... 0-1-2-3-4-5-6-7-8

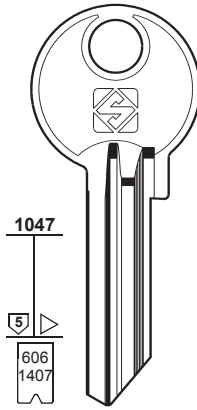
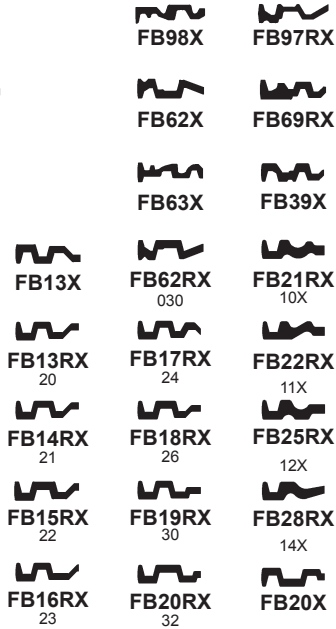

..... 0-1-2-3-4-5-6-7-8
..... 0-1-2-3-4-5-6-7-8

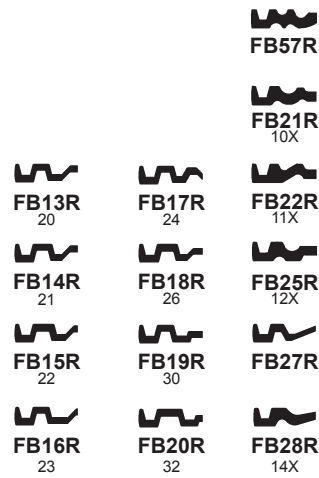

83

PER / FOR

FAB (CZ)

PER:
FOR:

FAB

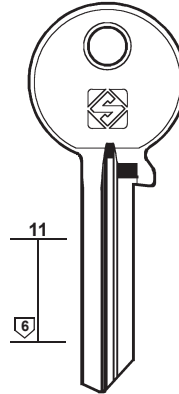
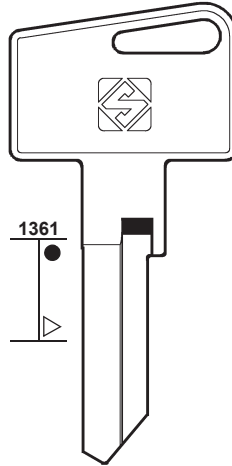
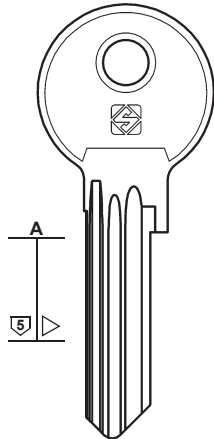
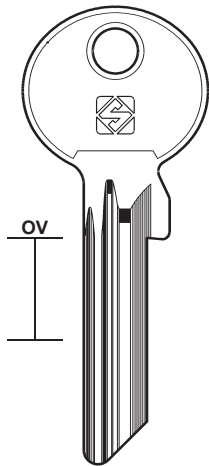
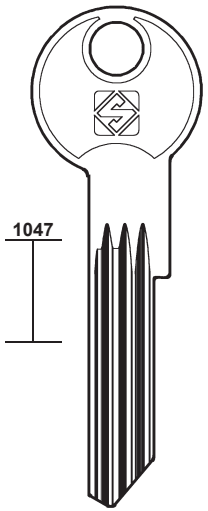

PER:
FOR:

FAB

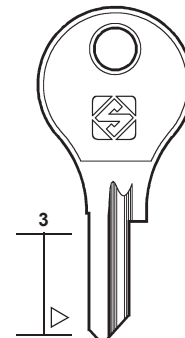
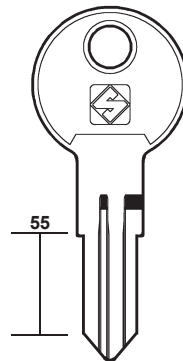
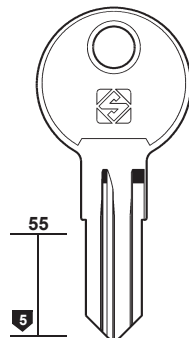
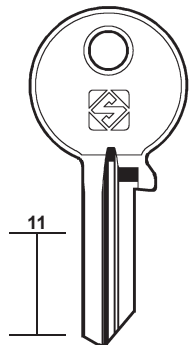
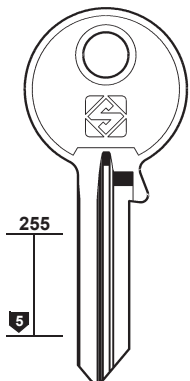



84

PER / FOR

FAC (ES)
ARREGUI
INDAUX

PER:
FOR:

FAC

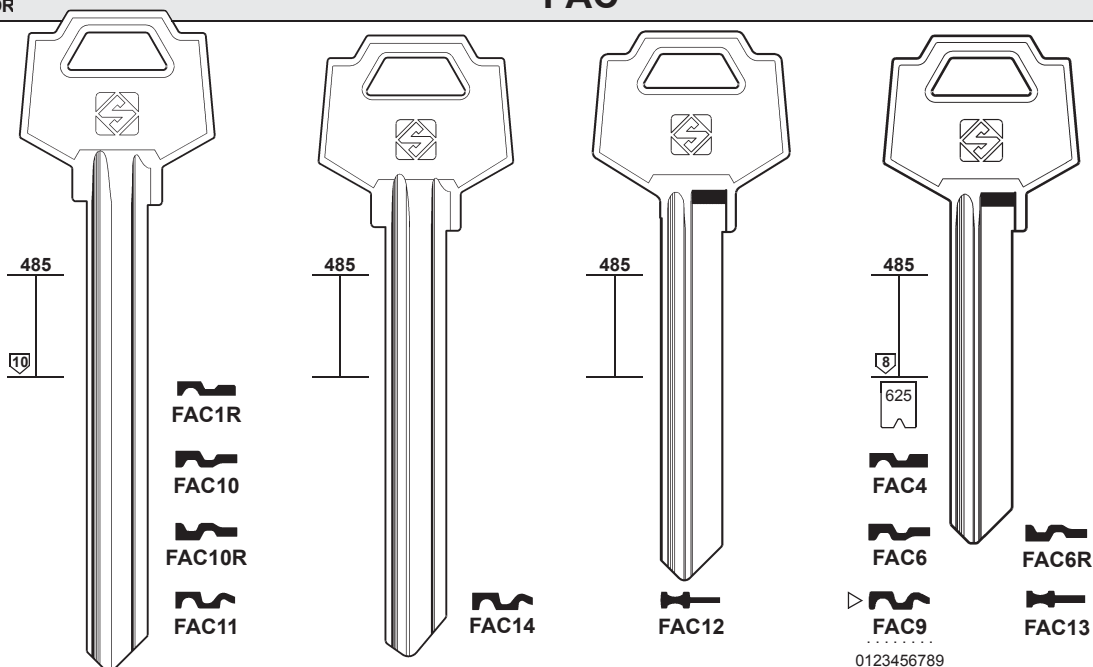

PER:
FOR:

FAC

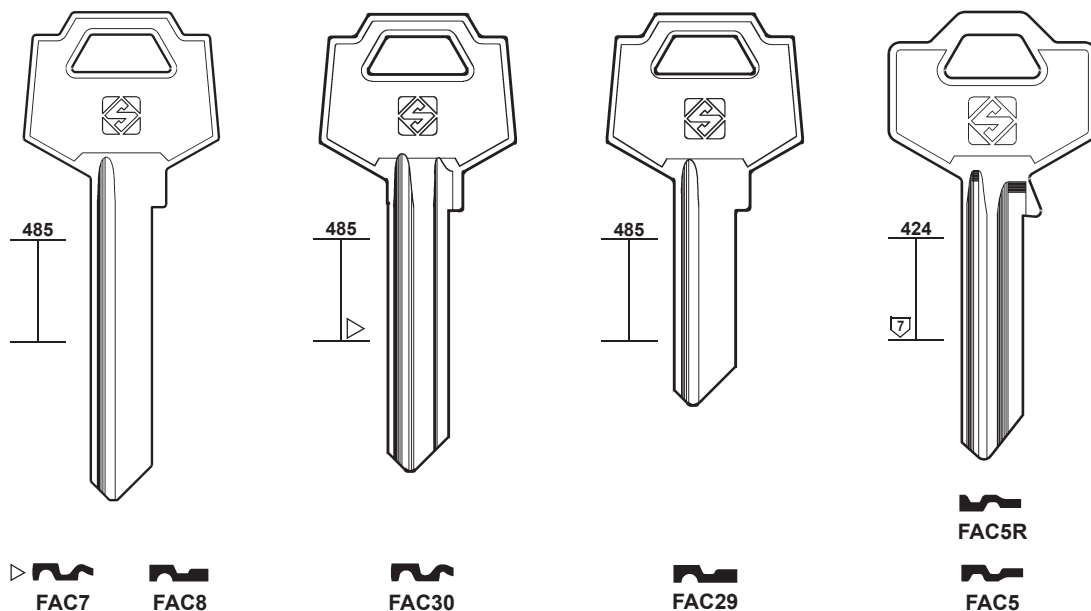

PER:
FOR:

FAC

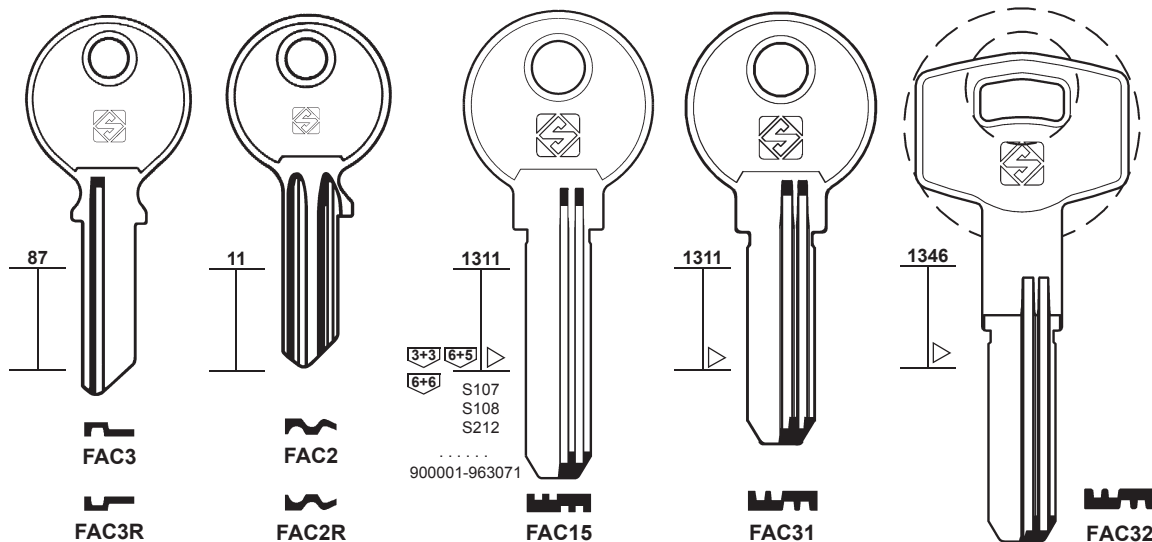

ARREGUI - INDAUX



PER:
FOR:

FAI

FALCON



85

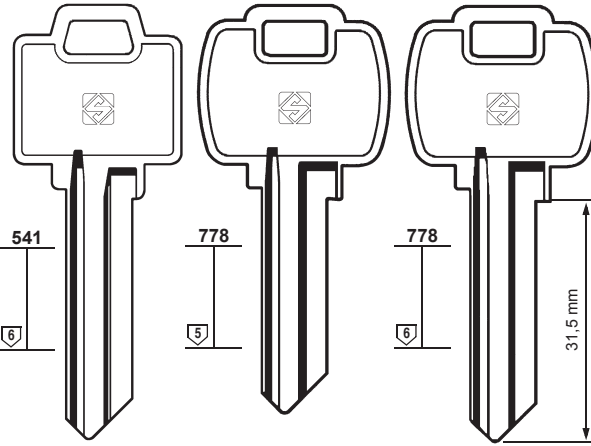
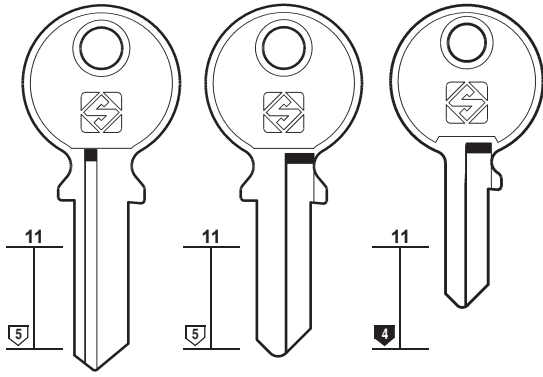

FAI1R

FAI2

FAI3

FN1

FN2

FN4



VIRO



VIRO

WEISER

WEISER

PER / FOR

FAI (IT)
VIRO
+ VIRO (205)

FALCON (US)
WEISER
+ BEST (33)
+ WEISER (208)

FAMA (IT)

FAMA (BR)

FANA (PL)
+ BRUMME (40)

FARCE (FR)
 MELSMETALL (136)

FAS (SE)

PER:
FOR:

FAMA (IT)

FAMA (BR)

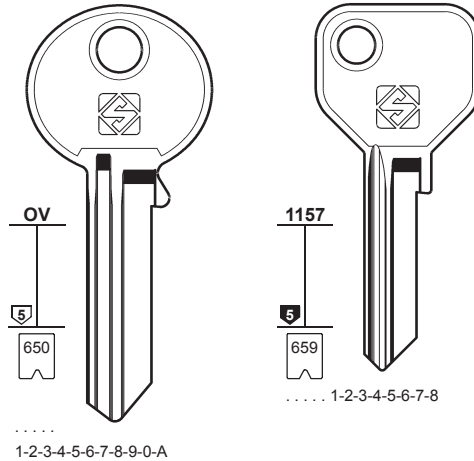
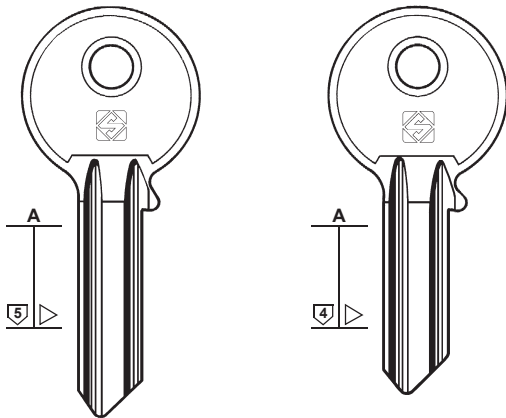

FAM1 FAM1R

FAM2 FAM2R

FAM6

FAM3

PER:
FOR:

FAMA (BR)

FANA

FAS

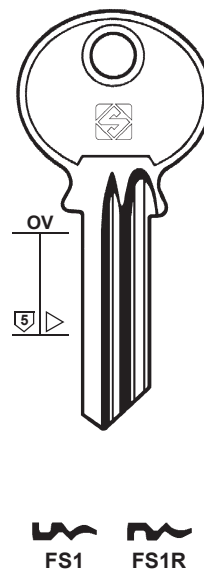
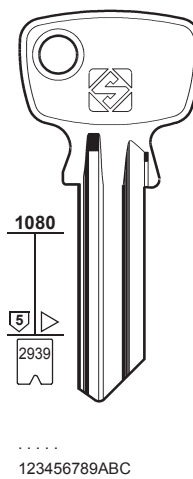
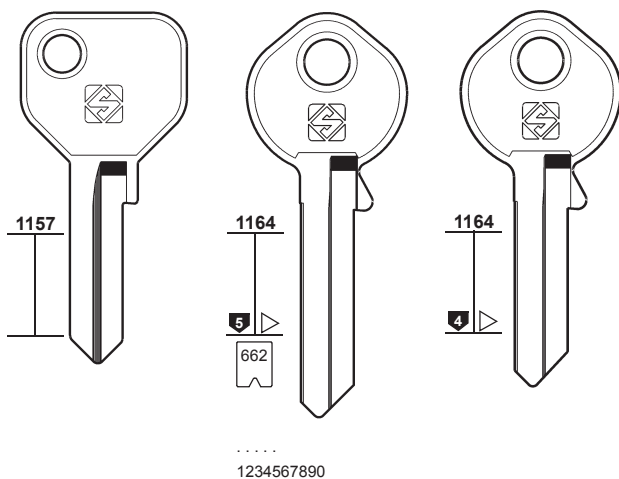

FAM9

FAM5

FAM8

FAN1

FS1 FS1R



86

PER / FOR

FASEM (IT)
BERETTA
BV
FPB
ILS
IULIA MAS FED
JUWEL
+ BIELLE (33)

FASMA (IT)
 EURO LOCKS (78)

FATTORINI (IT)
 PREFER (157)

FAVOUR (DZ)

FAYN (TR)

FB (ES)
 AGA (11)

FBC (IT)
 GIUSSANI (96)

PER:
FOR:

FASEM

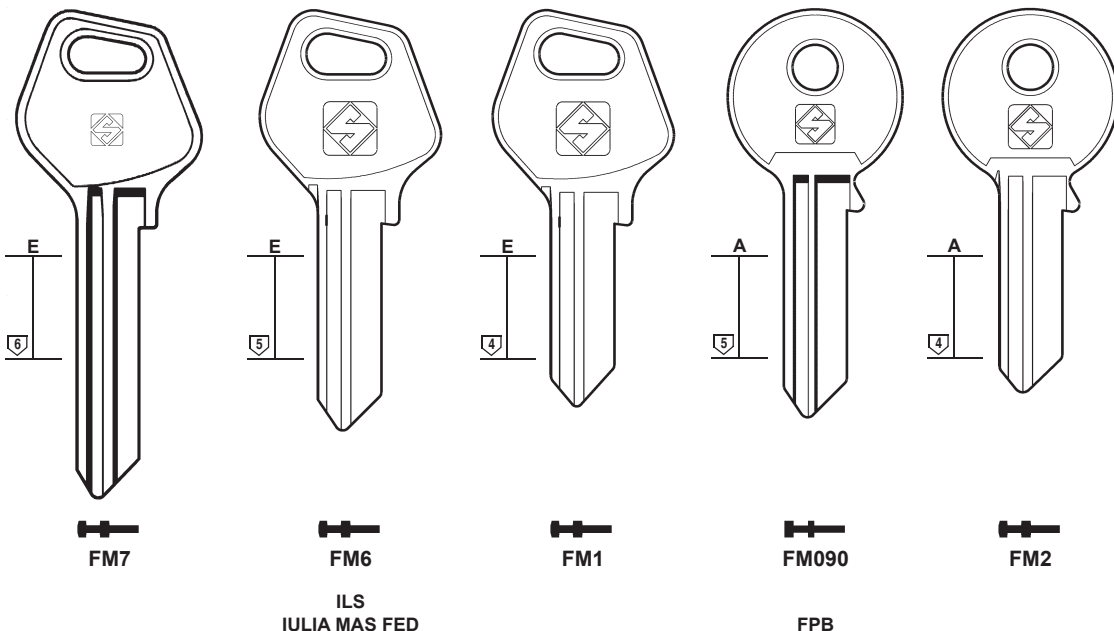

PER:
FOR:

FASEM

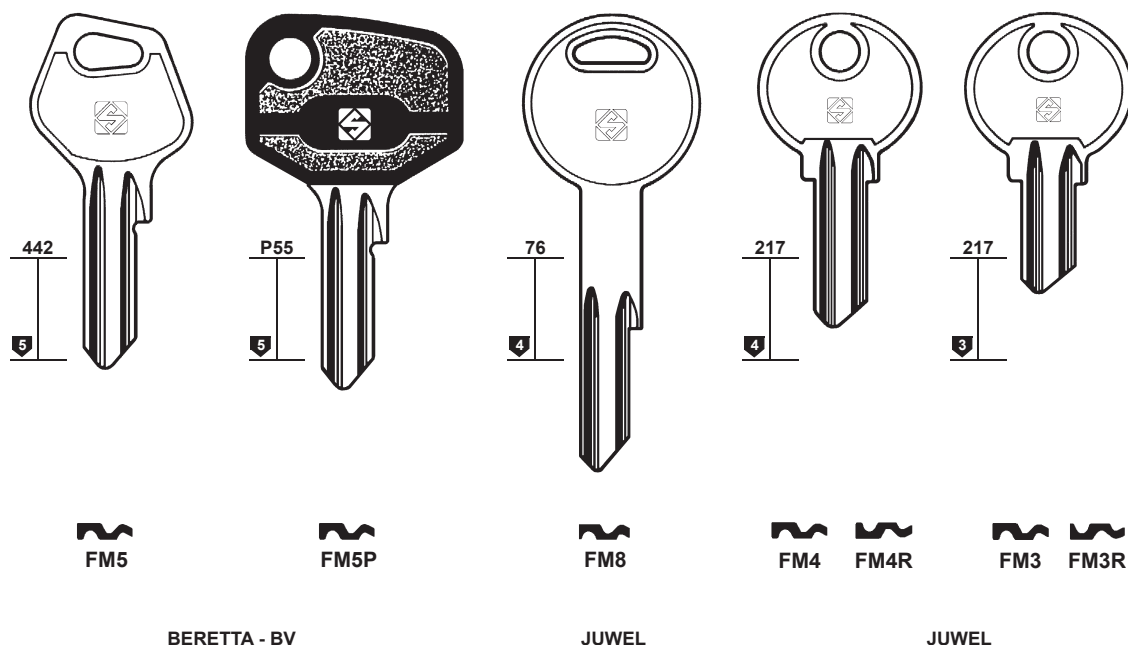

PER:
FOR:

FAVOUR

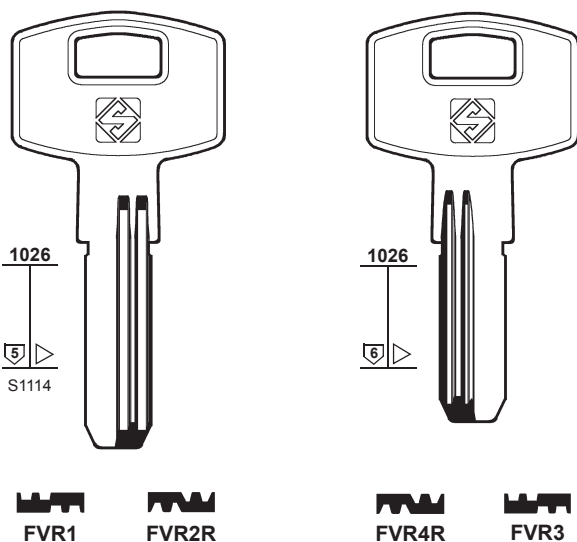

FAYN

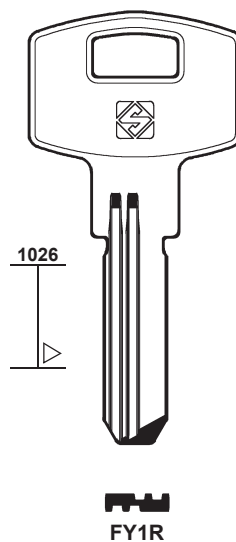

PER:
FOR:

FCV

FEB

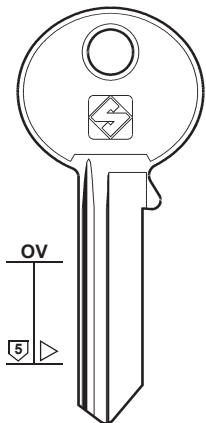

FCV1

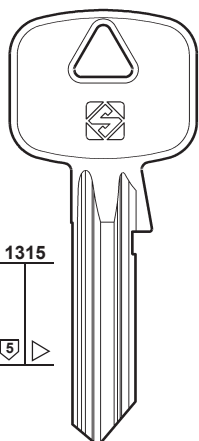

FCV2

KFV

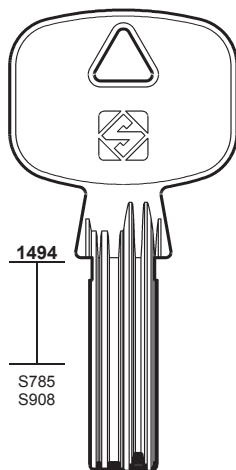

FCV4



KFV - VBH

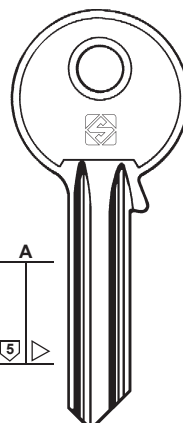

FEB2

FEB2R

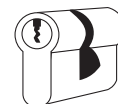

87

PER / FOR

FCV (DE)
KFV
VBH

+ KFV (116)

FEB (IT)

- + ALPHA (16)
- + CORBIN (60)
- + JVAL (112-113)
- + MORI E. (142)
- + P.C. (CORTELLEZZI) (153-154)
- + VIRO (205)

FEDERAL (FR)

- + FTH (91-92)
- + JUNKUNC (112)

FEFI (DE)

- + CES (47)

FEL (DE)

- + SIS (170)

FERCO (FR)

- + YALE (214)

FERMABLOCK (IT)

- + OLIVA (148)

FERONERIA (RO)

F.F. (IT)
GUARDIAN

PER:
FOR:

FEB

FEDERAL

FERONERIA

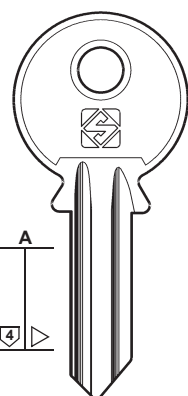

FEB1

FEB1R

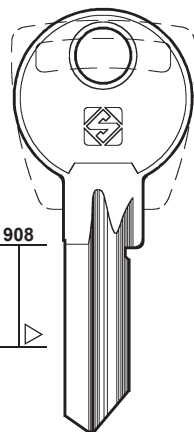

FEB6R

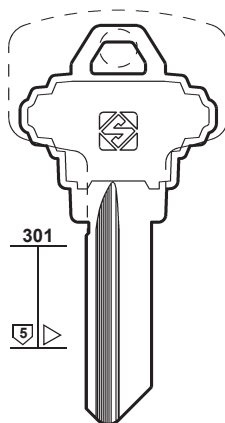

FDR1

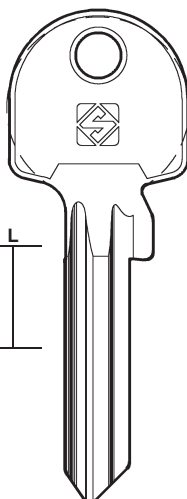

FDR2

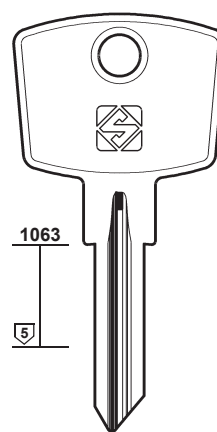

FRN1R

PER:
FOR:

F.F.

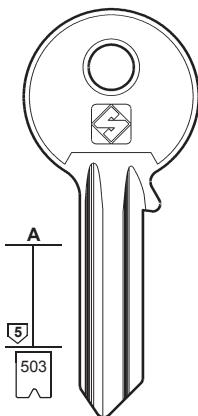

FF1

FF1R

.....0-1-2-3-4-5-6-7

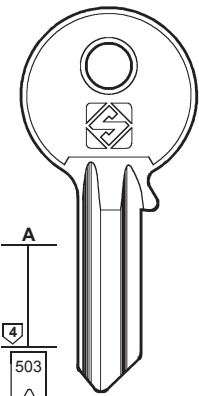

FF2

.....0-1-2-3-4-5-6-7

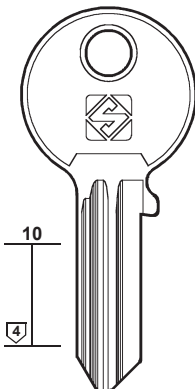

FF15

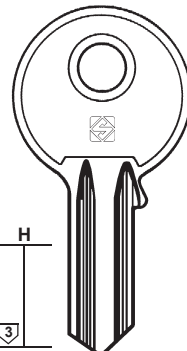

FF3

FF3R

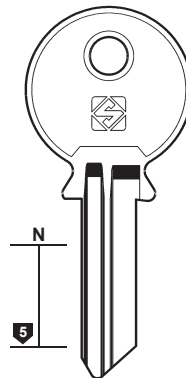

FF14

FF8

FF8R

FF9

FF9R

FF10

FF10R

FF17

FF7
FF7R

GUARDIAN

GUARDIAN



88

PER / FOR

F.F. (IT)

FIAM (IT)

+ KESO (116)

FIC (SA)

+ ZANI (220)

PER:
FOR:

F.F.

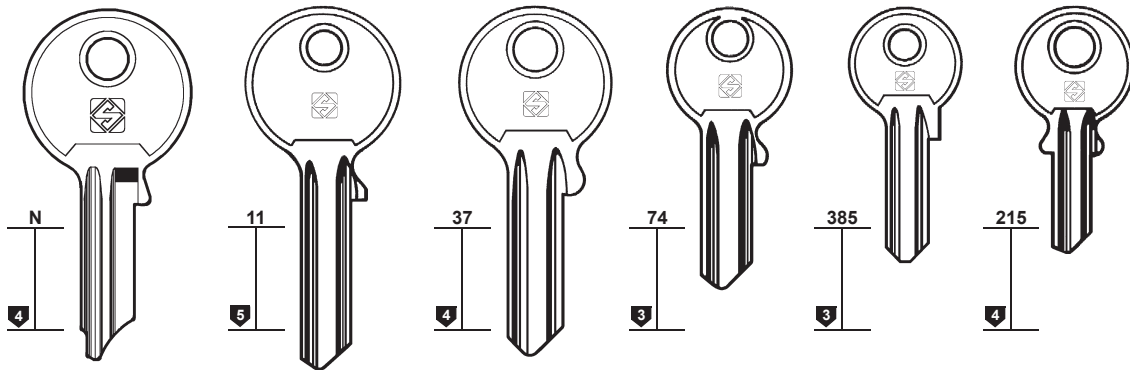

FF18

FF4

FF4R

FF12

FF12R

FF5

FF13

FF6

FF11

FF11R

FF5R

FF13R

FF6R

PER:
FOR:

F.F.

FIAM

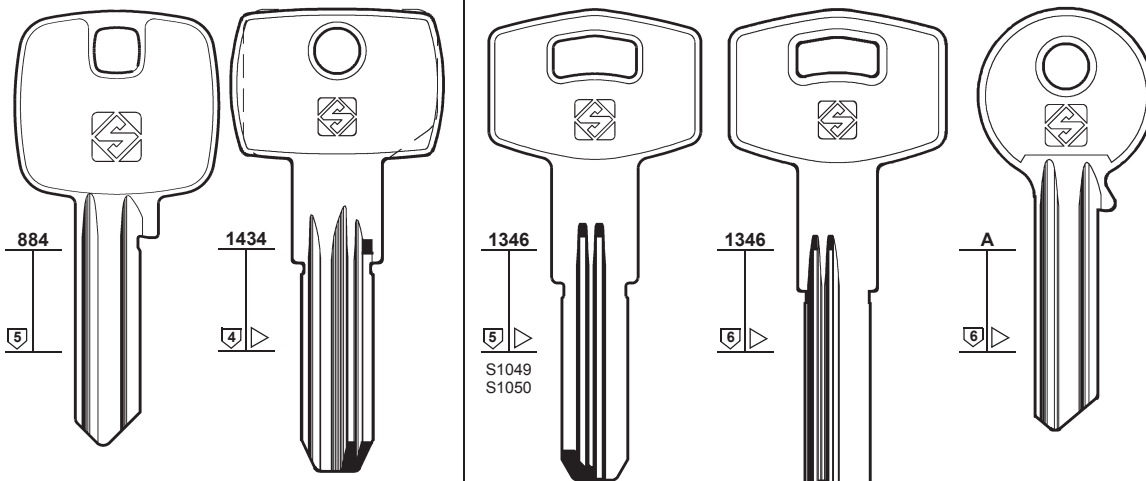

FF16

FF19

FI3R

FI4R

FI6

PER:
FOR:

FIAM

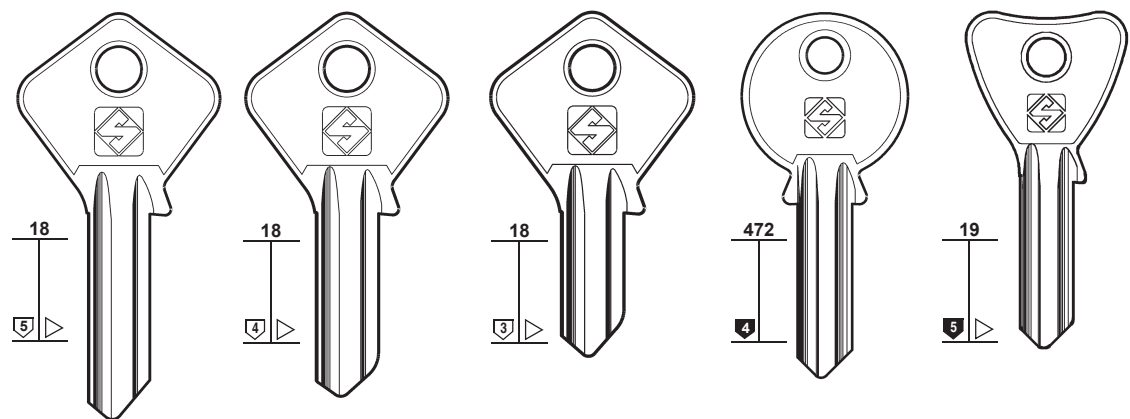

FI1

FI234

FI235

FI232

FI233

FI1R

FI2

FI064

FI065

MORI E.

PER:
FOR:

FICHET

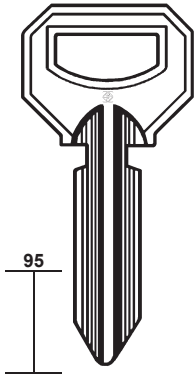

TECNOR

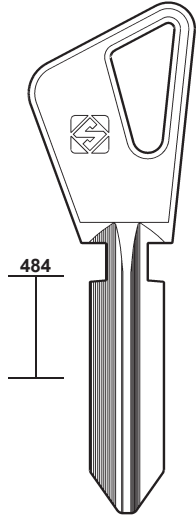

FT4



SURFINOR

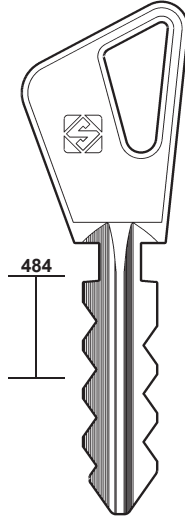

FT4C



SURFINOR

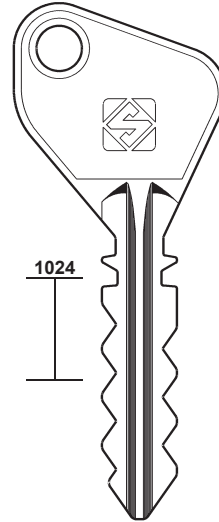

FT5C



89

PER / FOR

FICHET (FR)
SURFINOR
TECNOR
+ TOK-WINKHAUS (187)

FIMANEVSKI (RU)
DNEPROPETROVSK
(67)

FIRMADOOR (AU)

FIRST (CH)

FIS (IT)

PER:
FOR:

FICHET

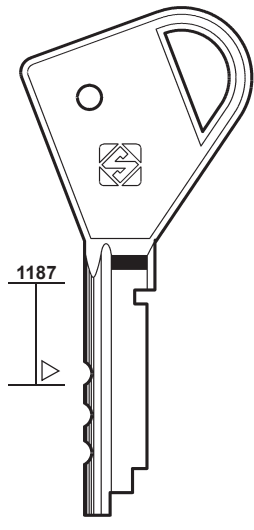

FT15R

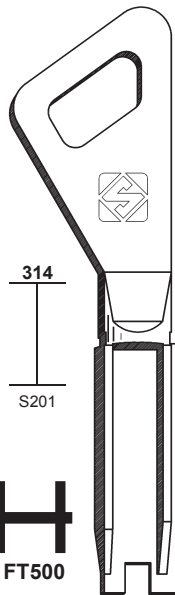

FT500

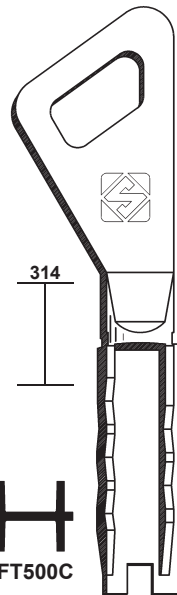

FT500C

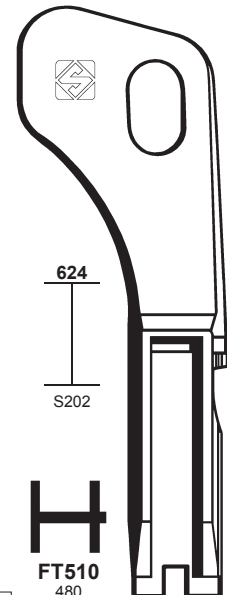

FT510
480



PER:
FOR: FIRMADOOR

FIRST

FIS

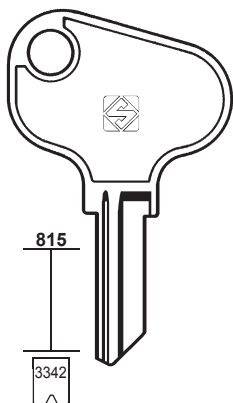

FID1
B... 1-100

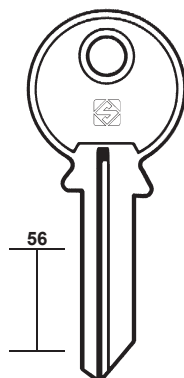

FIR1

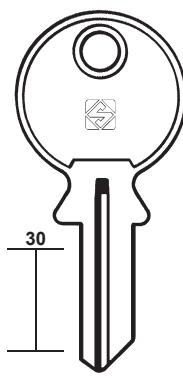

FIR1R

FIR3

FIR2R

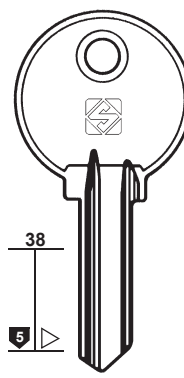

F1

F1R

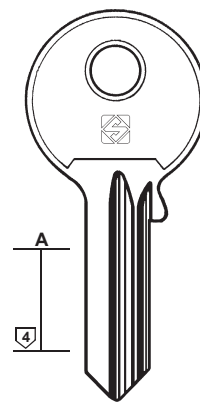

F2R



90

PER / FOR

FIST (IT)

FLAMBO (DE)

👁️ DOM (69)

FLIETHER (DE)

👁️ KFV (116)

FLIK (DE)

+ 👁️ GEGE (93)

FLIM (RU)

FLOHR (DE)

👁️ FLORA (90)

FLORA (DE)

FLOHR

NB

NORDWEST

SUKI

FO (FR)

👁️ CITY (58)

👁️ MONOBLOC (141)

👁️ ZENITH (222)

FONDAR (IT)

OT

FONTAINE (FR)

👁️ CORNI (62)

👁️ RONIS (161)

👁️ VACHETTE (199)

FORINDEX (FR)

👁️ RONIS (161)

FORT (US)

ARFE

DAD

DECAYEUX

EMKA

EURO BOX

HUDSON

SECURITAL

UTZ

+ 👁️ ABUS (9)

+ 👁️ ARROW (20)

+ 👁️ CHICAGO (51-52)

+ 👁️ LAS (122)

FORTIS (ES)

LBLM

FORTSCHRITT (DE)

👁️ DOM (70)

👁️ ZEISS-IKON (221)

FOSAM (IT)

👁️ PREFER (157)

FOUR-CIRCLE (TW)

👁️ YETI (218-219)

FPB (IT)

👁️ FASEM (86)

👁️ P.C

CORTELLEZZI (153)

FRAL (PT)

👁️ P.C.

CORTELLEZZI (153)

FRANZEN (US)

FRANZMAR (BR)

FRECOV (DE)

👁️ CES (47)

FTH (F)

PER: FOR:	FIST	FLIK	FLIM	FLORA
	 20 47	 54 5 ▶	 P419	 123 5 ▶
	 FIS1R FIS1 FIS3	 FK1	 FLM1P	 FL2 FL2R
				 FLOHR - NB NORDWEST - SUKI

PER: FOR:	FONDAR	FORT					
	 327	 132 6 1069	 743 5 247	 1171	 625 4 671	 1135	
	 FD1	 FRT1 H 6001-6250 RM 7001-7200	 FRT4R FRT5R ... 1-500 ... 9001-9500	 FRT7	 FRT8 FRT9R ... 501-600 ... 601-700	 FRT6R	
	OT	HUDSON	DAD - DECAYEUX EMKA - EURO BOX SECURITAL - UTZ		ARFE	DAD	

PER: FOR:	FORTIS	FRANZEN	FRANZMAR		FTH
	 1201	 55	 1428 4 ▶	 1553	 388 ▶
	 FOS1	 FRE1R	 FRZ1	 FRZ2	 FH7
	LBLM				

PER:
FOR:

FTH

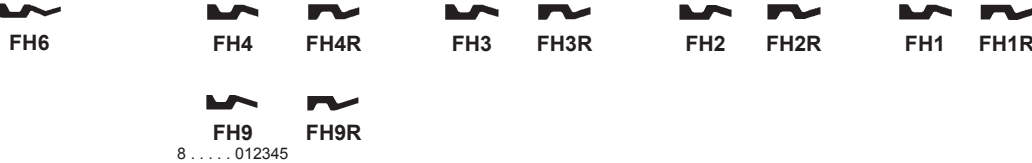
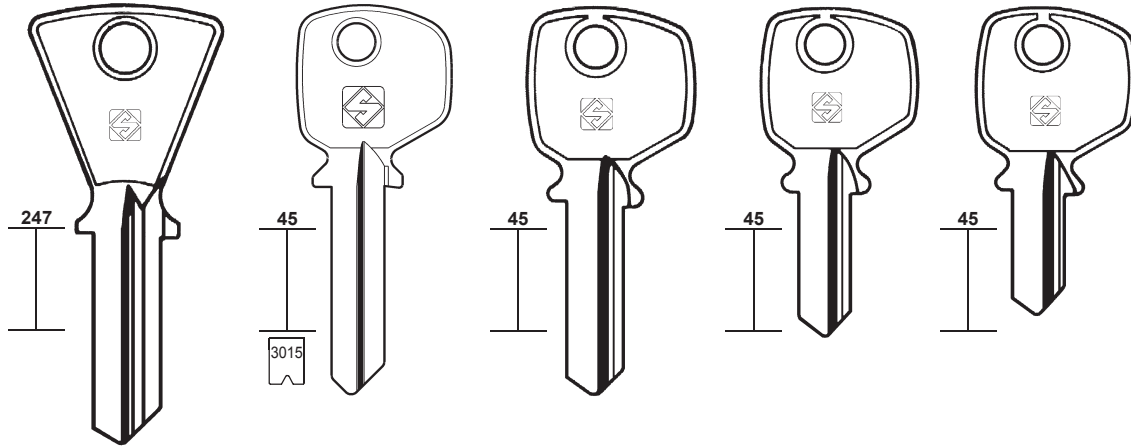

91

PER / FOR

FTH (FR)

- CF
- CIB
- CIBC
- CITY
- DIAMA
- FEDERAL
- GISS
- GPR
- HUNIT
- IFAM
- JL
- NICO
- PICARDIE
- PROBAT
- SAMA
- SUF

- + ABUS (8)
- + BRUMME (40)
- + CAS-CISMA (45)
- + GLOBE (97)
- + TITAN (183)

PER:
FOR:

FTH

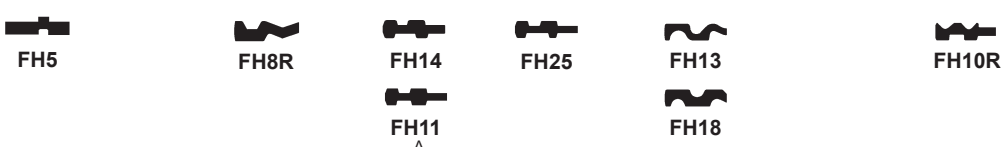
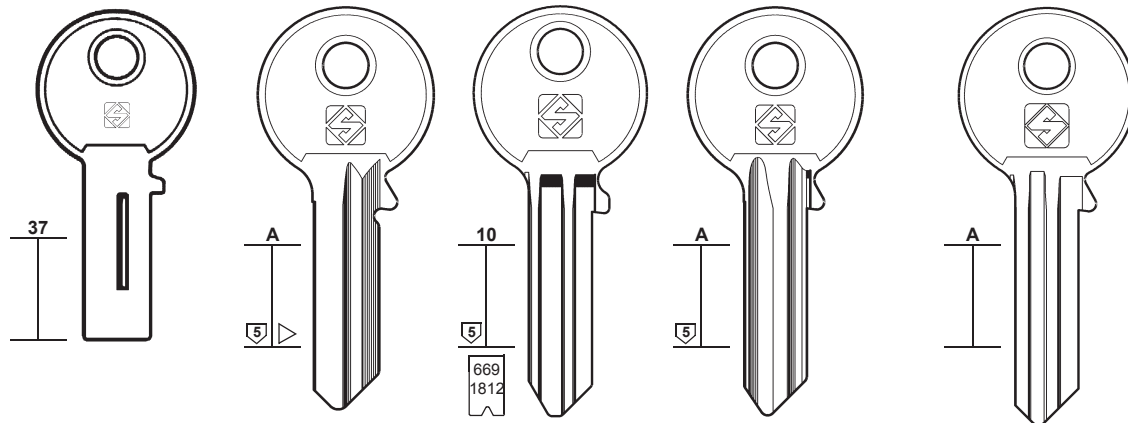

.....A
A (NEW)
 123456789

CITY - DIAMA - GISS - GPR
 HUNIT - PICARDIE - SAMA

CF - CIB - IFAM - JL
 NICO - PROBAT

PER:
FOR:

FTH

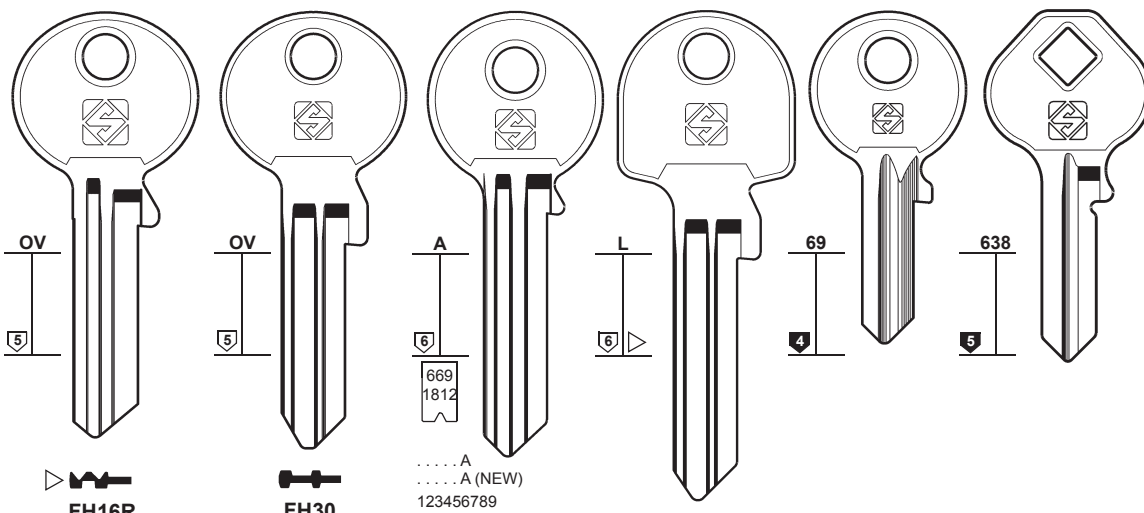

CIBC - CITY - SUF



92

PER / FOR

- FTH (FR)**
 CODEM
 FEDERAL
 GOTTA
 IFAM
 ITO
 KARO
 SP
 TOVER
 YALTRES
 + ABUS (8)
 + BRUMME (40)
 + CAS-CISMA (45)
 + GLOBE (97)
 + TITAN (183)

FUARO (RU)

- FUHR (DE)**
 CES (47)
 JOWIL (110)

- FULLEX (FR)**
 GEGE (93)

PER:
FOR:

FTH

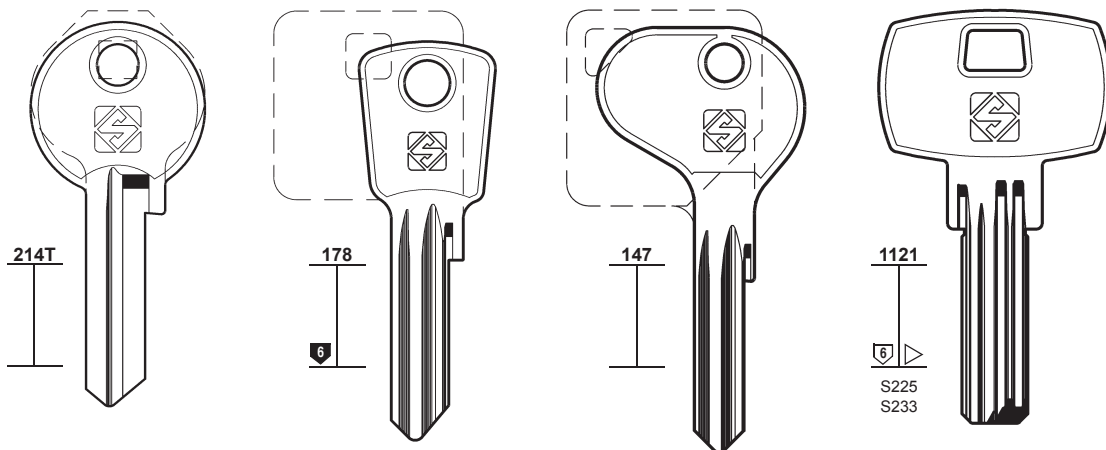

FH23R FH21R FH22R FH24R FH12

FEDERAL FEDERAL FEDERAL CODEM - GOTTA - ITO TOVER - YALTRES

PER:
FOR:

FTH

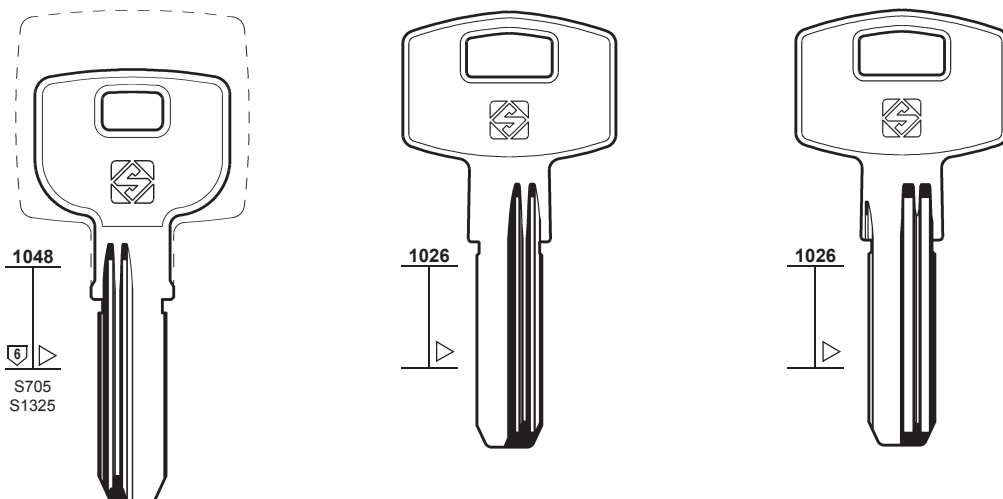

FH17R FH37R FH32 FH33

IFAM KARO SP

PER:
FOR:

FTH

FUARO

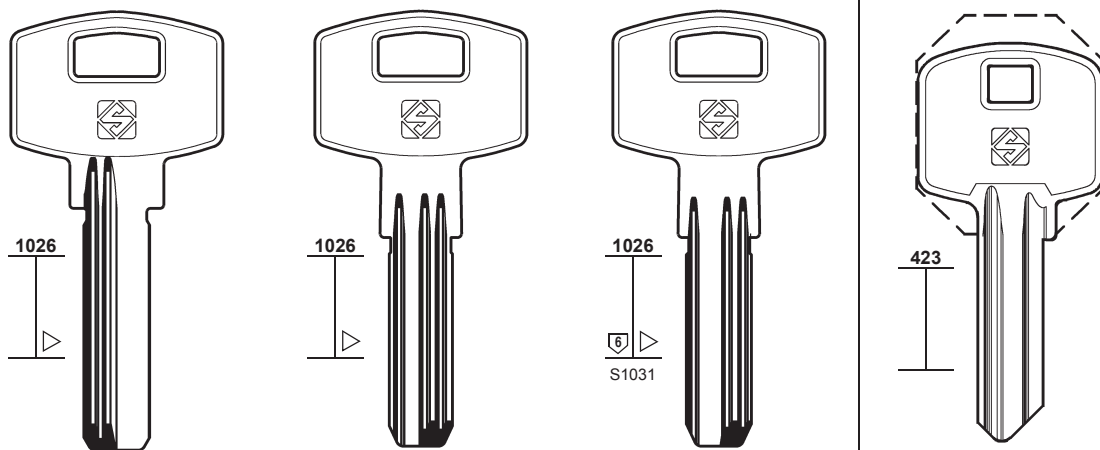

FH34R FH35 FH36 FU1

SP SP

PER:
FOR:

GABON

GATEMATE

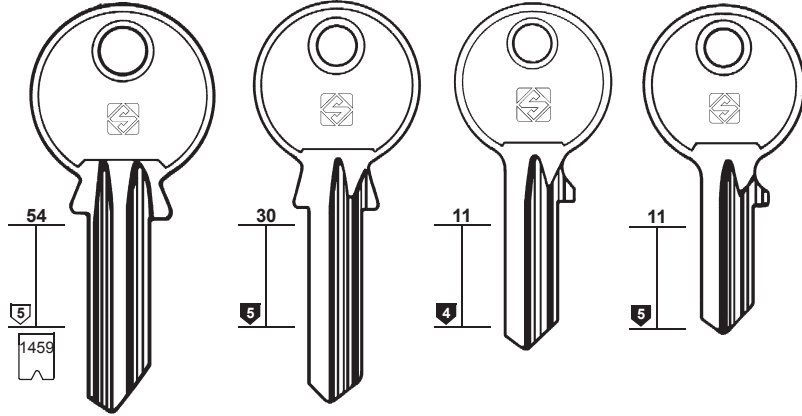

GB5

B 2000-7700



GB5R

CHG - DESPREZ - GALLUS
JOLY - MAXIGARD - PICARDIE
SOS - SUREX - WINNER



GB1



GB3



GB2

CHG - GALLUS
MAXIGARD - PICARDIE
SOS - WINNER

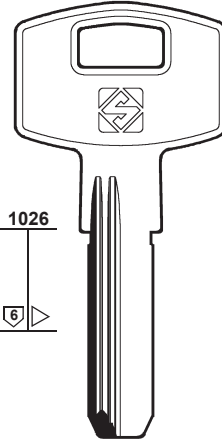

GAT1R



93

PER / FOR

GABON (FR)

CHG
DESPREZ
GALLUS
JOLY
MAXIGARD
PICARDIE
SOS
SUREX
WINNER

GAINSBOROUGH (AU)

LOCKWOOD (127)
TESA (181)

GALLUS (FR)

GABON (93)

GARI (ES)

AGA (11)

GARRISON (GB)

MUL.T.LOCK (144)

GATEMATE (GB)

GB (FR)

GBS (DE)

GEA (IT)

GEBA (DE)

+ BKS (34)

GEBRO (DE)

CORONA (63)

GEFI (DE)

CISA (55)

GEGE (AT)

ABUS
FLIK
FULLEX
GLOSTAL
GRUNDMANN
HÖHRMANN
PEROHAUS
TZAFRER
+ ABUS (7)

PER:
FOR:

GB

GBS

GEA

GEBA

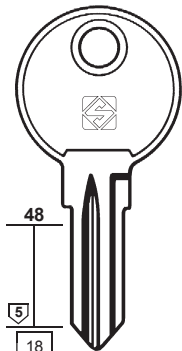

K18

W



K18R

Z



K110

Y



K110R

C

1-224

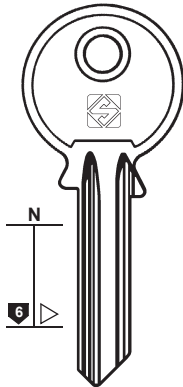

WK3

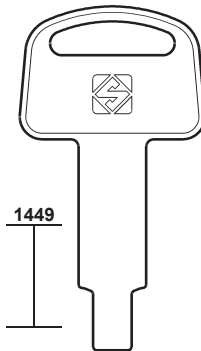

GEA4

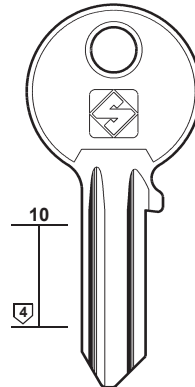

GBA1

PER:
FOR:

GEGE

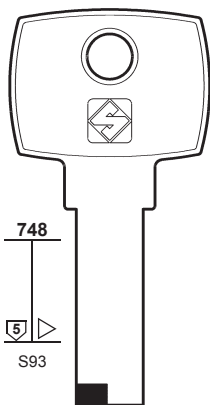

GE57

Z
101-120

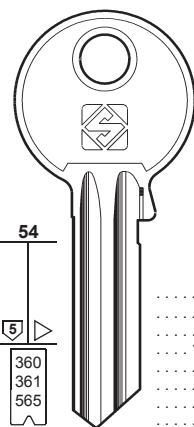

GE1



GE1R

FULLEX
GLOSTAL
GRUNDMANN
HÖHRMANN
PEROHAUS

. 000000-210079
. () 1234567890
. () 1234567890
. 1234567890ABCDEF
. 1234567890ABCDEF
. () 1234567890ABCDEF
. 5000001-5067680
. 500001-545303



GE4



GE4R



GE8R



GE119



GE34



GE7R



GE9

ABUS - FLIK - TZAFRER



94

PER / FOR

GEGE (AT)
LABOFA
PEROHAUS
+ ABUS (7)

GEM (US)
CHICAGO (52)

GENTILI (IT)
CILA (53)

PER:
FOR:

GEGE

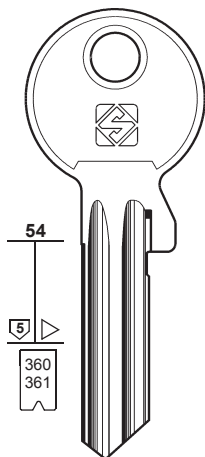

..... 5000001-545303
..... (.)
1-2-3-4-5-6-7-8-9-0

- GE182X
- GE119X
- GE52X
- GE34X

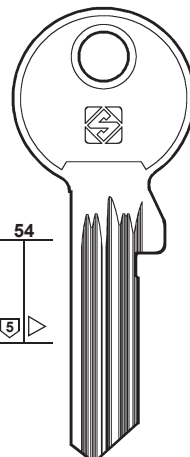

- GE178RX-7 GE178RX-8
- GE178RX-6 GE178RX-11
- GE178RX-5 GE178RX-12
- GE178RX-4 GE178RX-13
- GE178RX-3 GE178RX-15
- GE178RX-2 GE178RX-16
- GE178RX-1 GE178RX-17

PER:
FOR:

GEGE

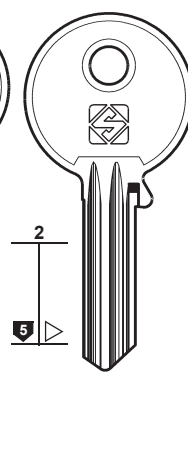
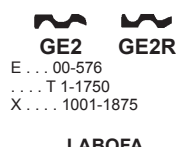
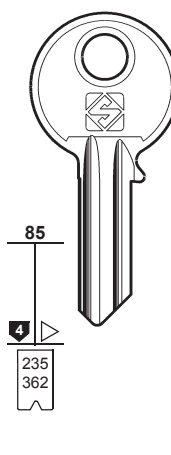
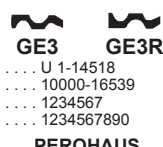
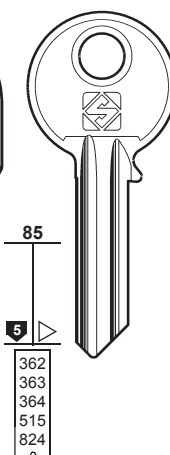
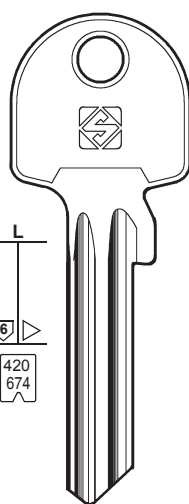
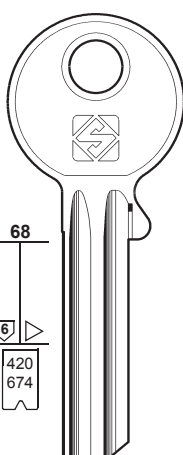
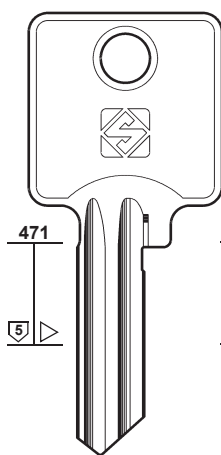

PER:
FOR:

GEGE

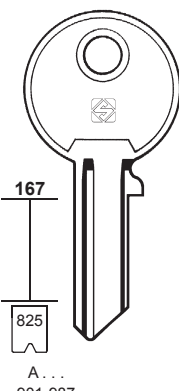
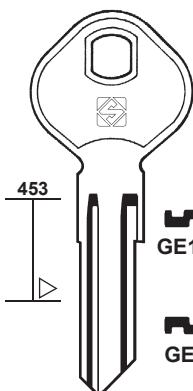

A...
901-987

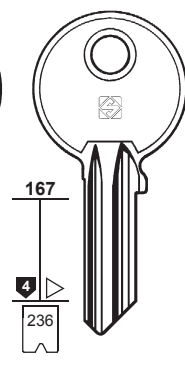

PER:
FOR:

GERA



95

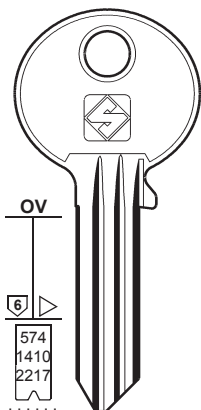

1-2-3-4-5-6-7-8-9
..... 1-2-3-4-5-6-7
N..... 1-28800

GR1R

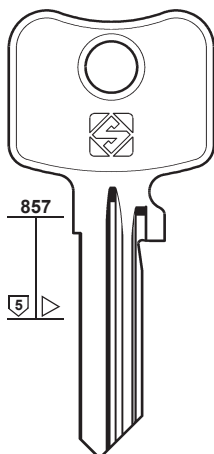

5

GR2R

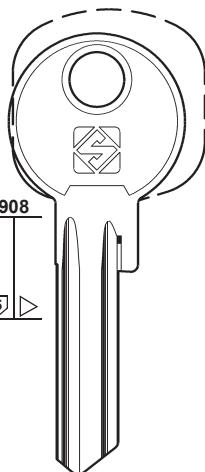

5

GR3
PZ6900

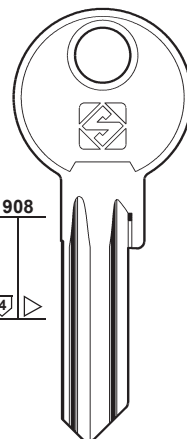

4

GR4
PZ5900

PER / FOR

GERA (DE)

- + BUVA (44)
- + ISEO (108)
- + SATURN (165)
- + STARLET (176)

GERDA (PL)

- MCM (134)

GETE (DE)

- CISA (55)

GEVY (GR)

- BASSI
MOTTURA
STUV
- + CISA (55)
 - + DELCA (65)
 - + P.C.
CORTELLEZZI (153)

GEWIRU (DE)

- DOM (69)

GEWISS (IT)

GHE (DE)

- EMKA (77)
- LA PORTE (121)

GHIDINI (IT)

- ZANETTI A. (220)

GIESCHE (GB)

- CES (47)
- KFV (116)

GIMM (FR)

- RONIS (161)

GIOBERT (IT)

PER:
FOR:

GERA

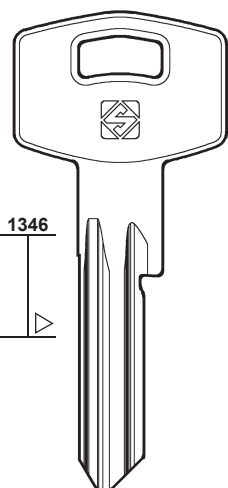

GR15

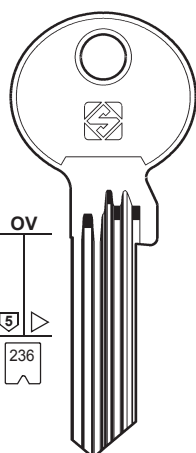

GR9R-1

GR9-9

GR9-8

GR9-7

GR9-5

GR9R-4

GR9R-3

GR9R-6

GR9R-5

GR9R-2

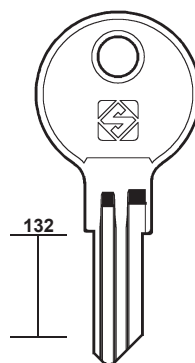

GR16

PER:
FOR:

GEVY

GEWISS

GIOBERT

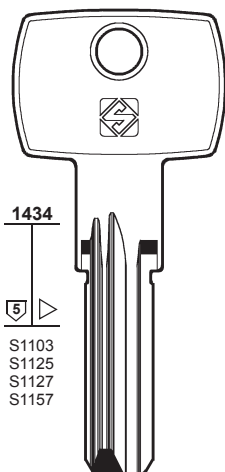

GVV1R

..... 600001-613040
..... 900001-902780

BASSI - MOTTURA - STUV

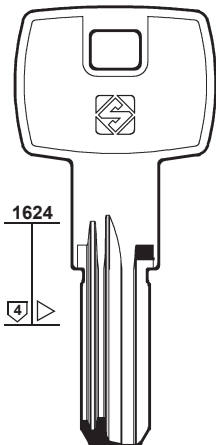

GVV2R

BASSI

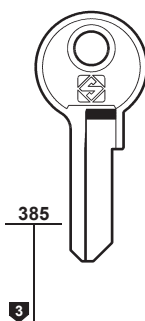

GWS1

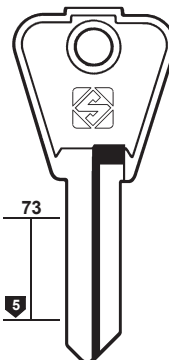

GT4

GT4R

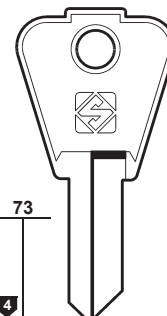

CM2

CM2R





96

PER / FOR

GIOBERT (IT)
OLIVETTI

GIBBONS (GB)
WILLENHALL

GIP (FR)

GISS (FR)
FTH (91)

GIUSSANI (IT)

BANKA
BRETER
CAB
ELSA
ELVOX
FBC
LUME
METALCASTELLI
MLP
OAL
PASTORE
PLG
SIMECA
+ BRETER (38)
+ TITAN (183)

PER: FOR:	GIOBERT	GIBBONS	GIP	GIUSSANI
	 21 308	 168	 46	 1384
	GT1 GT3R OLIVETTI	GT3 E GT3R F WILLENHALL	GN1 GP1	GS17

PER: FOR:	GIUSSANI				
	 22 207	 558 1590	 2 5	 2 4	 2 3
	GS1 GS4R E...9001-9741 SM1R GS9	GS1R GS4 E...3001-3480 SM1 9001-9741 G... 3001-3480 3001-3480 9001-9741 0-480	GS13 ... 1-2-3-4	GS3 GS3R GS2 GS2R	GS10 GS10R
	CAB - ELSA - ELVOX PLG - SIMECA	OAL - LUME	BRETER	FBC - MLP	METALCASTELLI

PER: FOR:	GIUSSANI				
	 167	 463	 54 5	 182 5	 A 4
	GS12R MLP	GS11R BANKA	GS5 GS6	GS8	GS7 PASTORE

PER: **GLAZIEV**

PER: **GLOBAL**

PER: **GLOBE**

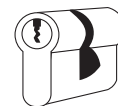

97

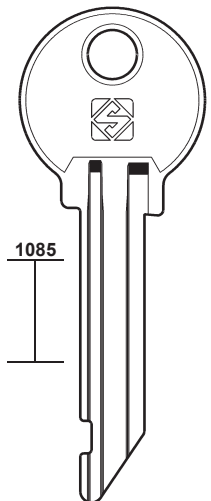

GLZ1

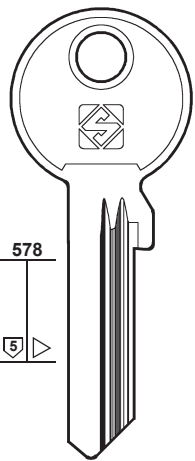

GBL1R

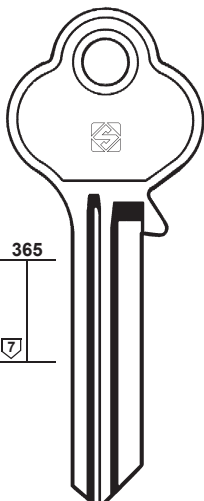

GL8

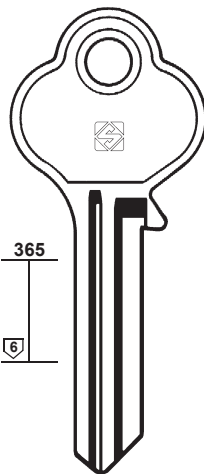

GL7



GL7R

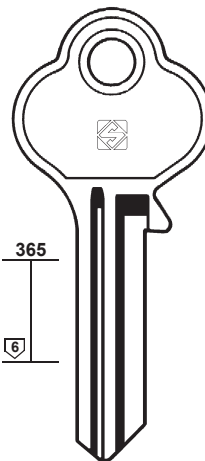

GL6



GL6R

PER / FOR

GLAZIEV (RU)

GLOBAL (GB)

GLOBE (TW)

ANLO

DOFIN

FTH

GOLD-DOOR

IFAM

LARK

LUCO

MIAN-FORCE

SOF

WHALE

+ GOLD DOOR (99)

+ HILLO (102)

PER:
FOR:

GLOBE

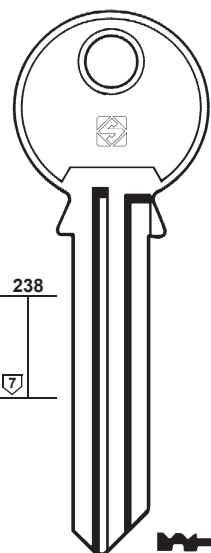

GL11R



MIAN-FORCE

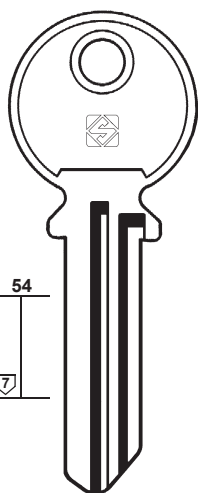

GL12R

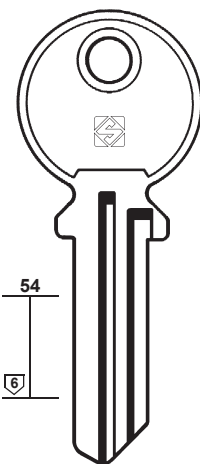

GL13R



SOF GOLD-DOOR

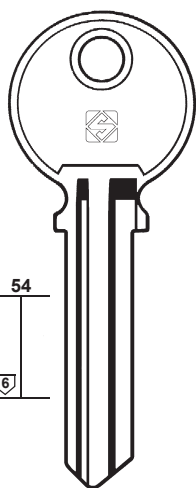

GL9



GL9R

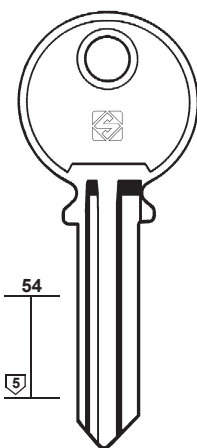

GL10



GL10R

ANLO - LUCO

PER:
FOR:

GLOBE

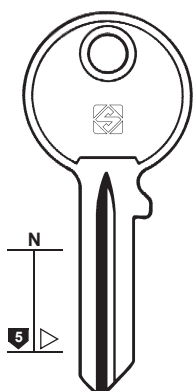

GL4

GL4R

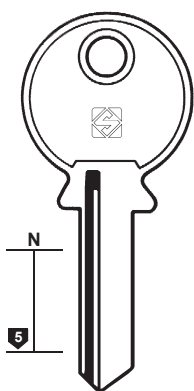

GL3R

GL3

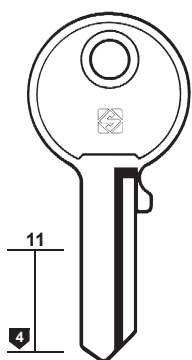

GL5

GL5R

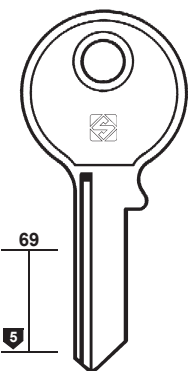

GL17R



**DOFIN - FTH
GOLD DOOR
SOF**

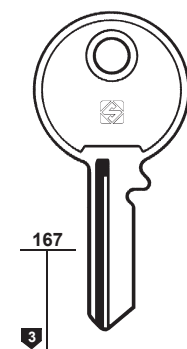

GL2R

GL2



IFAM



98

PER / FOR

GLOBE (TW)
GOLD-DOOR
+ * HILLO (102)

GLOSTAL (DE)
GEGE (93)

GOAL (JP)
+ * GSS (100)

GODREJ (IN)

GOLD (BR)

PER:
FOR:

GLOBE

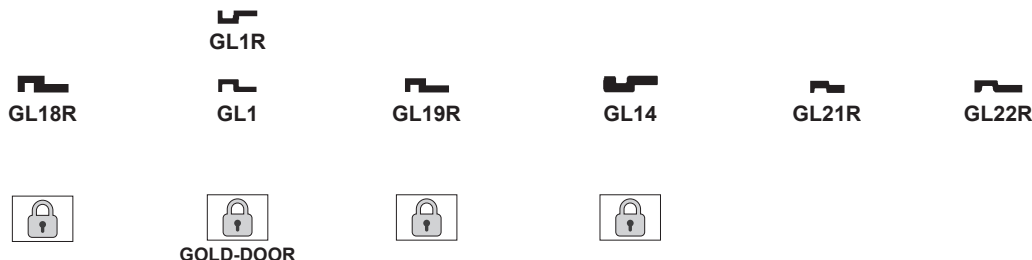
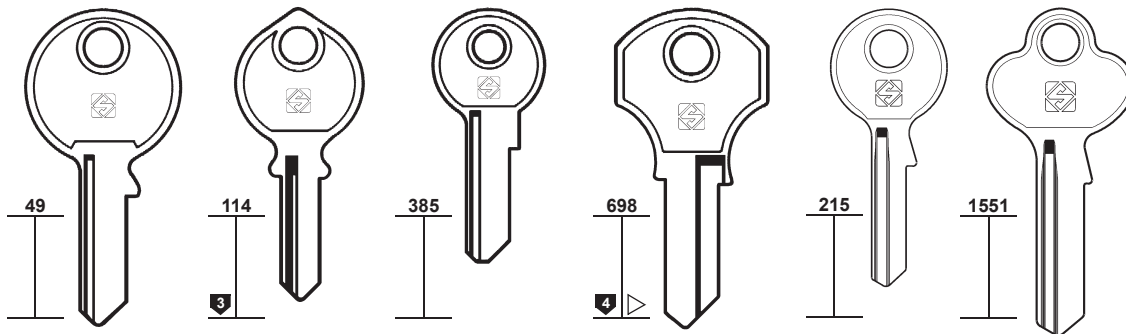

PER:
FOR:

GOAL

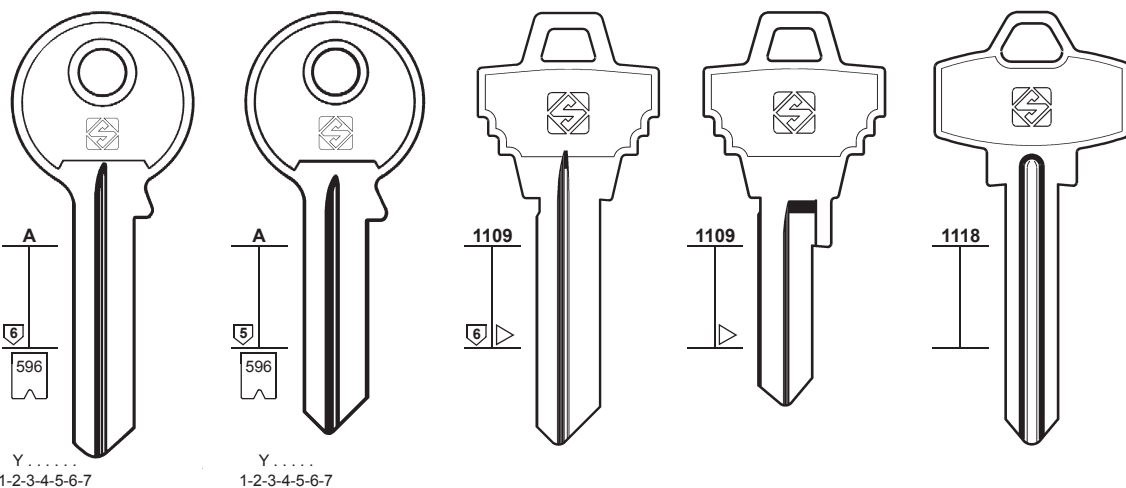

PER:
FOR:

GOAL

GODREJ

GOLD

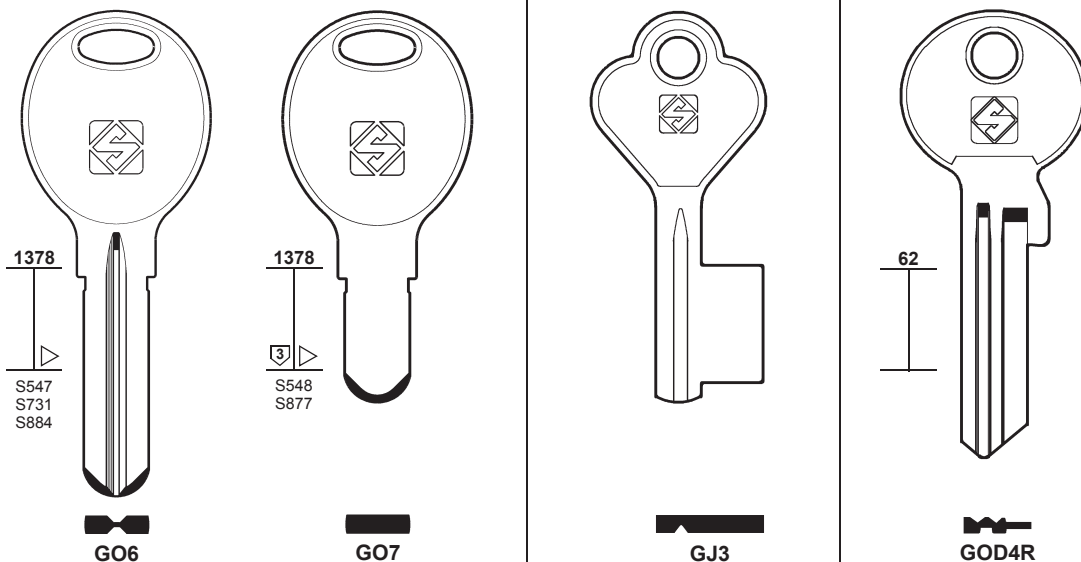

S547
S731
S884

S548
S877



PER: **GOLD DOOR** GP G.R. (GUERVILLE RIQUIER)



99

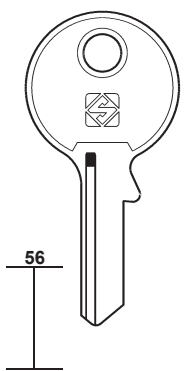

GLOBE

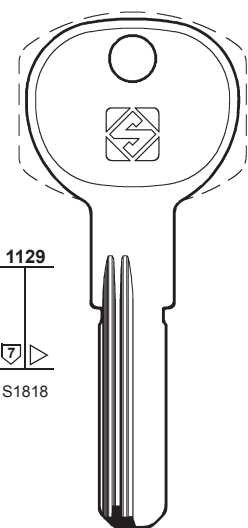

GPI1

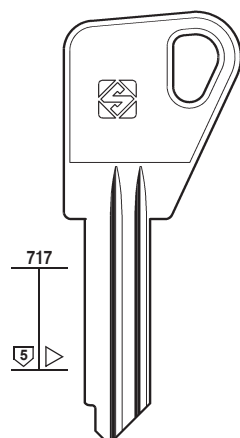

RIQ10R

PER / FOR

GOLD-DOOR (TW)
GLOBE
+ GLOBE (97-98)

GOLLOT (FR)
RONIS (161)

GOTTA (DE)
FTH (92)

GÖTZ (DE)
KFV (116)

GP (IT)

GPR (FR)
FTH (91)

G.R. (FR)
(GUERVILLE-RIQUIER)
ABUS
BRICARD
DEBEURAIN
MONDIAL
PERRIER
SE

GRAF (DE)
KFV (116)

GRAYHILL (US)
ILLINOIS (106)

PER: **G.R. (GUERVILLE RIQUIER)**

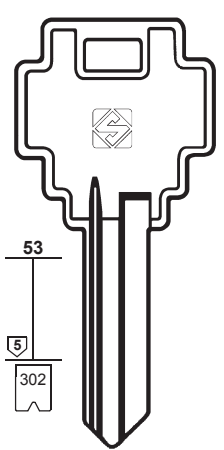

RIQ3

R 1234567890



RIQ2

F 1234567890
G 1234567890



RIQ6S

Y 1234567890

MONDIAL

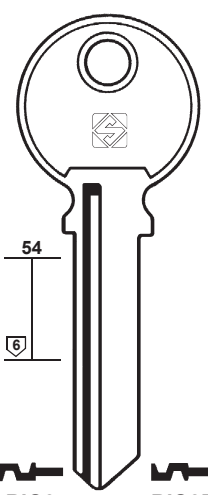

RIQ8



RIQ8R



RIQ7



RIQ7R

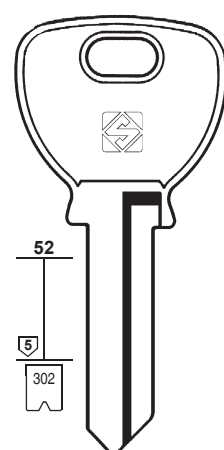

RIQ1

Z 1234567890



RIQ1R

T 1234567890
XT 1234567890
Y 1234567890

DEBEURAIN - SE

PER: **G.R. (GUERVILLE RIQUIER)**

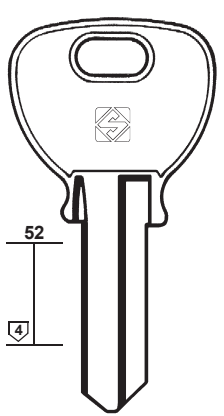

RIQ5



RIQ5R

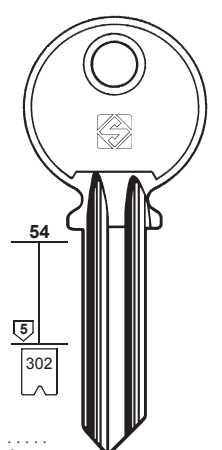

RIQ4



RIQ4R

.....
A
1-2-3-4-5-6-7-8-9-0

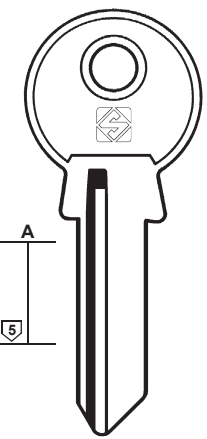

RIQ9



RIQ9R

BRICARD - PERRIER

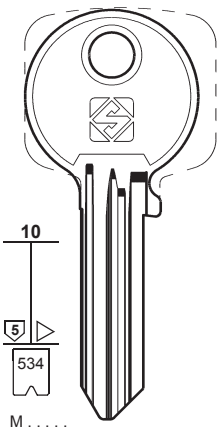

RIQ11



RIQ11R

M
P
S
1-2-3-4-5-6-7-8-9-A-B-C-D-E-H-K-L

ABUS - BRICARD

PERRIER



100

PER / FOR

GRIFO (TW)

GRUNDMANN (AT)

GEGE (93)

GS (GR)

STAR (175)

GSA (IT)

CAS-CISMA (45)

GSS (JP)

GOAL

GTV (DE)

JOWIL

TIEFENTHAL

+ CISA (55)

+ EMR (77)

+ JOWIL (110)

GUARD (HK) (CZ)

ABUS

EKLA

ROYAL

+ ABUS (8)

+ FAB (82)

GUARDIAN (I)

CAS-CISMA (45)

F.F. (87)

PER: **GRIFO**

FOR:

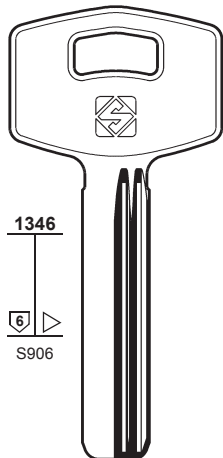

1346



S906



GF1



PER: **GSS**

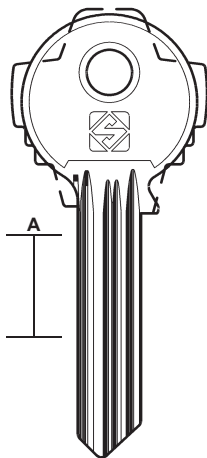

A



GSS1

GOAL

PER: **GTV**

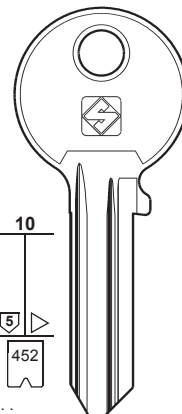

10



452

.....

0-1-2-3-4-5-6-7-8-9



GV1



GV2



GV3



GV4R



GV5R



GV6R

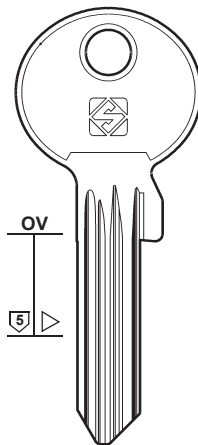

OV



GV7

JOWIL - TIEFENTHAL

PER: **GUARD**

FOR:

GUARD

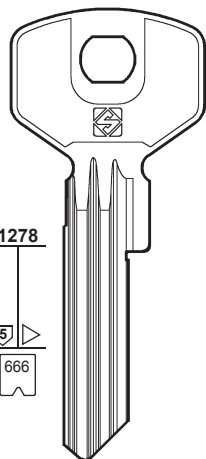

1278



666



GD10

14T1..... 00000-99999

14T..... 00001-80000

14T..... 80001-99999

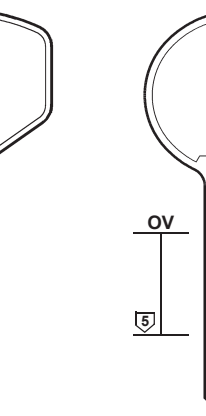

OV



GD10R

13T1..... 00000-99999

13T..... 00001-80000

13T..... 80001-99999

13T2..... 00000-99999

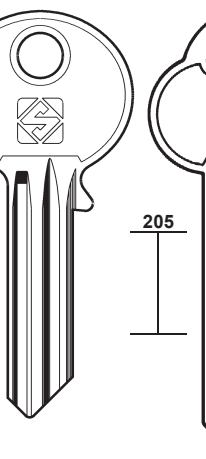

GD8



GD8R

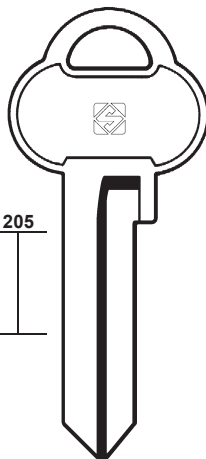

205



GD5

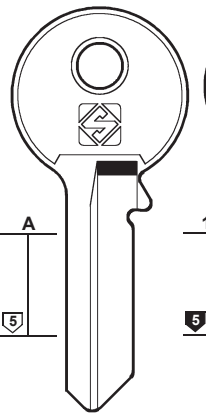

A



GD2

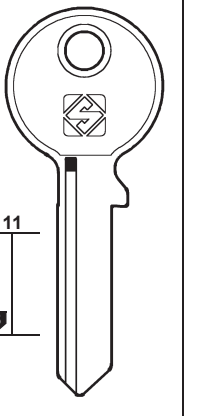

11



GD4



ABUS - EKLA - ROYAL



PER: **GUARD**

FOR:

GUARD

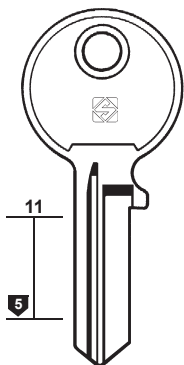

11



GD6R

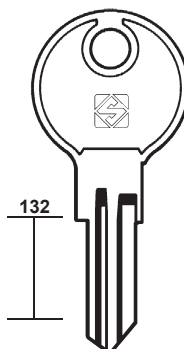

132



GD3

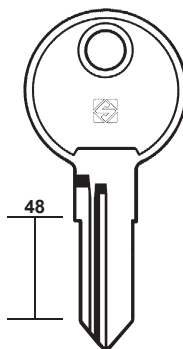

48



GD7R

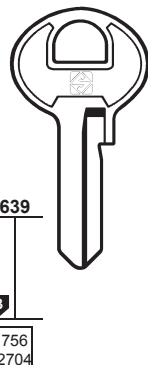

639



756
2704



AB23

... 1-24

... 65/251-2-3-4-5



AB23R



ABUS



277



GD1



GD1R



mm 25

ABUS

PER: FOR:	GUARUP	GUSHENG	HÄFELE		
	GUR1	GUS1	HF1R	HF73R	HF74 HF74R
					O.M.R.



101

PER / FOR
GUARUP (BR)
GUSHENG (DE)
GUIDOTTI (FR) + RONIS (161)
GUITTEL (FR) + ABUS (8)
GÜTLER (DE) + SIMECA (170)
HÄFELE (DE) O.M.R. + BKS (34) + CES (47-48) + DOM (68-70) + HUWIL (104) + KIFERM (117) + LAS (121)
HABO (DK) + ASSA (25)
HAGA (BR)
HAIDE (TW) + YETI (218-219)
HALLE (DE) + BAB (29)
HAMPTON (GB) + MASTER (131)
HANNO (DE) + CES (47)
HARLOC (US) + EAGLE (75)
HARP (HK)
HASLER (DE) + SEA (166)
HASMAN (IN)
HB (IT) + LEGALLAIS (122)
HBC (DE) + MELSMETALL (135)
HDL-PACRI (BR)

PER: FOR:	HÄFELE	HAGA			
	HF75 HF75R 1-3936	HAG1 HAG1R	HAG6R	HAG7 HAG7R	HAG5
	 1-2-3-4-5-6			

PER: FOR:	HARP	HASLER	HASMAN	HDL-PACRI
	HP1R	HS1R	HA1R	HDL3 HDL3R

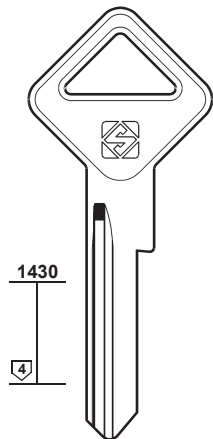
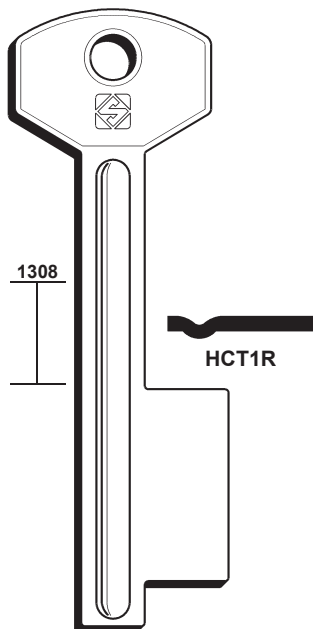

102

PER / FOR**HDL-PACRI (BR)****HEAD (TW)**👁️ **YETI (218-219)****HECTOR (ES)****HEGO (DE)**👁️ **CORBIN (60)****HEKNA (DE)****METALCASTELLI
RAUCO
REGENT**+ 👁️ **DOM (68-69)**+ 👁️ **HR (103)****HEL (ES)****HEMA (TW)**👁️ **VACHETTE (199)****HEMY (FR)**👁️ **YETI (218-219)****HENDERSON (GB)****REGENT**+ 👁️ **UNION (193)****HERMES (TW)**👁️ **YETI (218-219)****HERO (DE)**👁️ **HILLO (102)**👁️ **HR (103)****HESTE (DE)**👁️ **CORBIN (60)****HILLO (TW)****GLOBE
HERO****HK (DE)****HMP (TW)**👁️ **ALPHA (16)****HOBBY (GB)**👁️ **EURO LOCKS (80)****HÖHRMANN (DE)**👁️ **BKS (34)**👁️ **CES (47)**👁️ **DOM (70)**👁️ **GEGE (93)****HOK (TR)****PER:
FOR: HDL-PACRI**1430
4**HDL1R****HECTOR**

1308

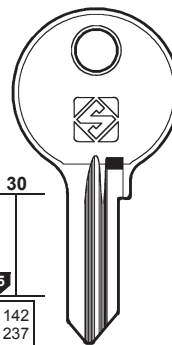
HCT1R**HEKNA**30
5
142
237**HN1**

... 1001-1425

HN4**HN2**

C... 1251-1700

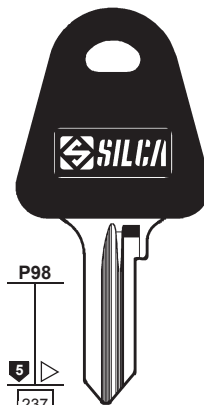
HN5RP98
5
237**HN1P**

... 1001-1425

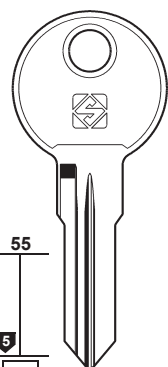
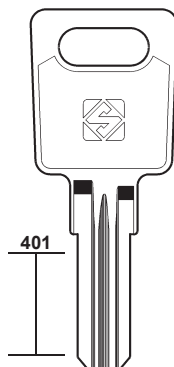
**METALCASTELLI
RAUCO - REGENT****PER:
FOR: HEKNA**55
5
755

401

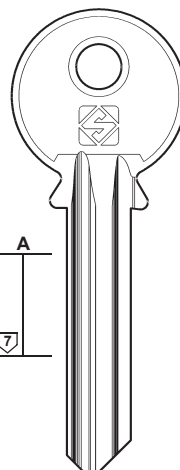
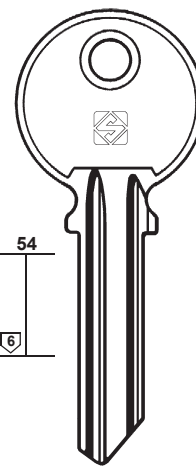
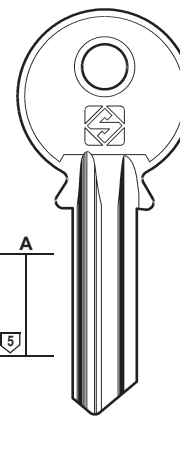
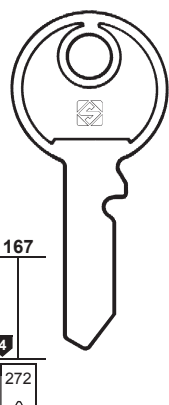
HN6**HN3**... 1-2-3-4
... 1501-1540**HN3R****HN7****HEL**A
7**HE3**54
6**HE3R****HE2****HE2R**A
5**HE1****HE1R****PER:
FOR: HENDERSON**167
4
272**HEN1**

R... 008-254

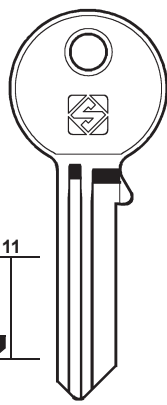
REGENT**HILLO**11
5**HL1R**

mm 40

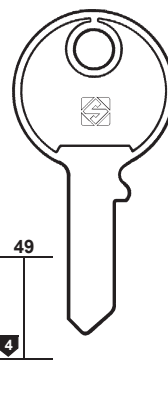
GLOBE - HERO**HK**49
4**H1****H1R**

mm 20

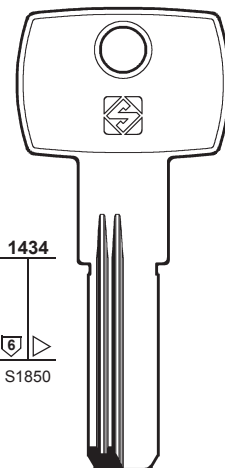
HOK1434
6
S1850**HOK1R****HOK2R**

PER: FOR:	HOPPE	HORSE	HR	HTEC
	1261 5 1643	438 5	521 5	132 1809 E... 1-698
	 HPP1	 HPP1R 1001-3187	 HO1R	 HO2R
	 HR1 E	 HTE1		
	 BURG - KIND MAUSER - TOKOZ		 HEKNA - HERO - OJMAR	



103

- PER / FOR**
- HOPPE (DE)**
BURG
KIND
MAUSER
TOKOZ
+ BURG (43)
 - HOOPLY (CN)**
 CINA (54)
 WANJIN (207)
 - HORSE (TW)**
HR (DE)
HEKNA
HERO
OJMAR
 - H.R.S. (FR)**
 TH (182)
 - HSA (DE)**
 KJV (116)
 - HTEC (ES)**
 - HTV (GB)**
SHAW
VAUGHN
YALE
 - HUDSON (US)**
+ FORT (90)
+ SEGAL (167)
+ YALE (213)
 - HUGIN (SE)**

PER: FOR:	HTV	HUDSON
	54 5	132 5 142
	 HT1 07	 HT1R
	 HT2 04	 HD8R
	 HD1R	 HD1 A... 201-1050 C... 500-699 H... 601-1100 HM... 201-1050
	 HD2	 HD2R ... 01-175
	 HD3	
	 VAUGHN	 SHAW - VAUGHN - YALE

PER: FOR:	HUGIN					
	178 5	178 5	616	616	616	616
	 HG1 A	 HG2 A	 HG3 P	 HG4 R	 HG5 X	 HG6 Z



104

PER / FOR**HUGO** (DE)
+ BRISANT (40)**HUNIT** (IT)
+ FTH (91)**HUTRA** (DE)
+ SCHLECHTENDAHL (166)**HUWIL** (DE)
CEKA
CHRIST
HÄFELE
L.M.C.
MAUSER
SCHÄRF
STEELCASE
STRAFOR
WILLACH
WÜRTH
+ BOMORO (37)
+ DOM (68)
+ EURO LOCKS (78)**IALEX** (PT)**IBFM** (IT)
+ EURO LOCKS (79)
+ L & F (128)

PER: FOR:	HUGO	HUNIT	HUWIL
	 1219 54 3763 HGO1R HGO2R 12345	 L 5 HUT1	 1170 1674 6 S1183 HW15R HW21R CEKA - HÄFELE MAUSER - SCHÄRF

PER: FOR:	HUWIL			
	 30 5 238 501 2500 HW1 2001-2207 N 2001-2204 N 2001-2207 N 5-1878 SO 8101-8300 LM 7946-8149 CHRIST - HÄFELE - L.M.C. WILLACH - WÜRTH	 P77 5 238 501 2500 HW1P	 48 HW2 R HW3 V	 401 6 539 1437 HW4 HW4R 000-051 0001-1915 0A-9Z IG. 14101-16020 22001-23920 DE. 25500-27419 A 3001-4000 W. 3001-4000 3001-4001 3010-3999 3202-4004 A 5001-5050 A. 5001-5050 5001-6169 7000-8001 PL. 7420-8419 RA. 7480-8479 7526-7726 FH. 7526-7726 8001-8321 8001-9541 LH 8701-9700 UO. 9000-9999 HÄFELE STRAFOR - STEELCASE

PER: FOR:	IALEX	IBFM		
	 54 6 IX1 IX1R	 22 IBF1 IBF1R	 1549 5 6 S1521 S1933 S1934 IBF2R	 1434 5 S1976 IBF3R

PER:
FOR:

IBM

ICA

ICSA

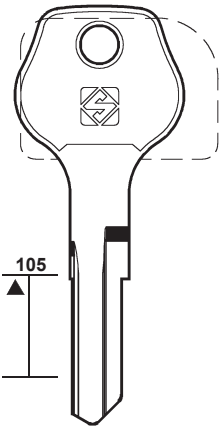

IBM1

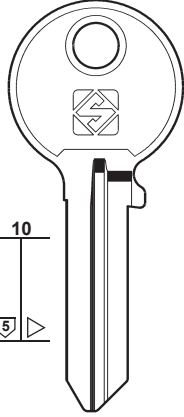

ICA1R

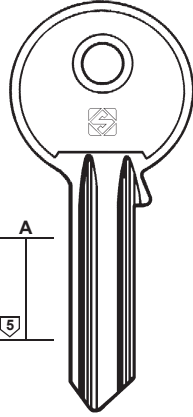

ICS1



ICS1R

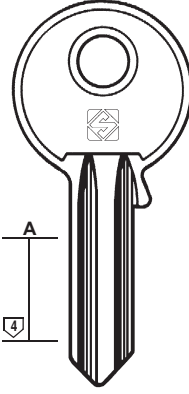

ICS2



ICS3



ICS3R

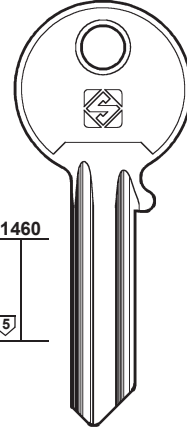

ICS5

ORLANDO
REMO - ZANI



105

PER / FOR

ICA (ES)

ICSA (IT)
ORLANDO
REMO
ZANI
+ LINCE (123)

IDEAL (TW)
 DOM (68)

IDEAL SECURITY (US)
 WEISER (208)

IDRO STOP (IT)
CEV

IES (IT)

IFAM (ES)
JOMA
RIPA
+ BUGA (40)
+ CHICAGO (52)
+ CISA (57-58)
+ FTH (91-92)
+ GLOBE (97)
+ ISEO (108)

PER:
FOR:

IDRO-STOP

IES

IFAM

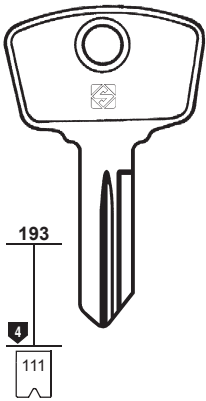

ISP2

... 1-78

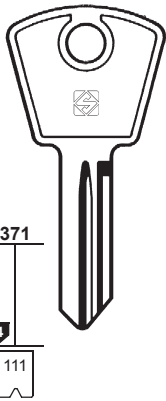

ISP4

... 1-78



CEV

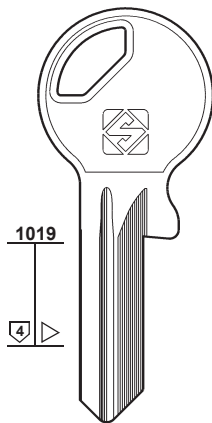

IES1R

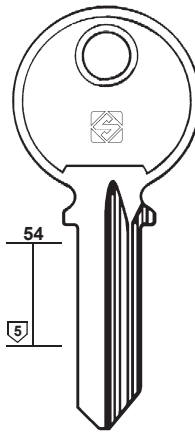

IF1

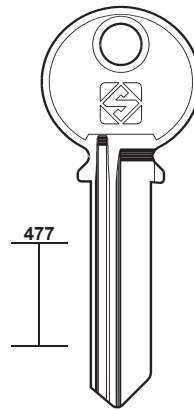

IF7

IF7R

PER:
FOR:

IFAM

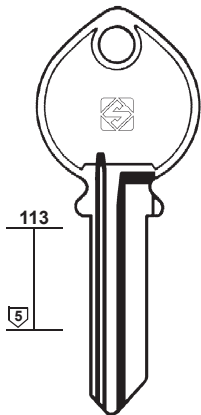

IF3

IF3R



mm 45-50-55

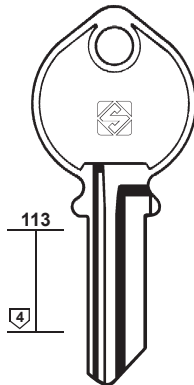

IF2

IF2R



mm 35-40 RIPA

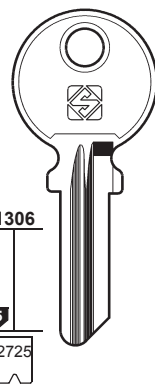

IF6

... 4001-4240



JOMA

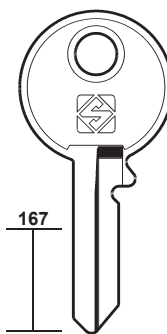

IF8

IF8R



JOMA



JOMA



106

PER / FOR

IFAM (ES)

- BATU
- JOMA
- RIPA
- TEM
- + BUGA (40)
- + CHICAGO (52)
- + CISA (57-58)
- + FTH (91-92)
- + GLOBE (97)
- + ISEO (108)

IGS (FR)

IJ (FR)

- JTF
- + JTF (111)
- + MERONI (137)
- + STAR (176)

IJN (FR)

- + KIFERM (117)

ILARGI (ES)

ILCO (US)

BARGMAN

ILLINOIS (US)

- GRAYHILL
- LAGRANGE
- OTIS
- SEEBURG
- + CHICAGO (51)

PER:
FOR:

IFAM

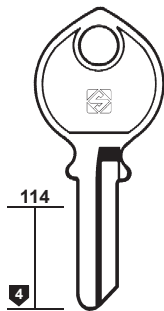

BATU - RIPA - TEM

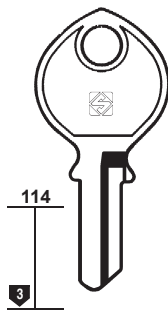

JOMA - TEM

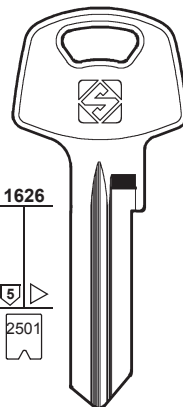

..... (D) 0123456
(D) 55002-58124

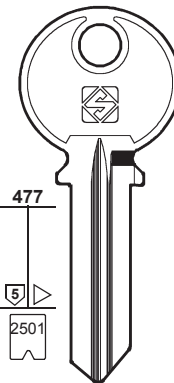

..... (D) 0123456
(D) 55002-58124

PER:
FOR:

IFAM

IGS

IJ

ILARGI

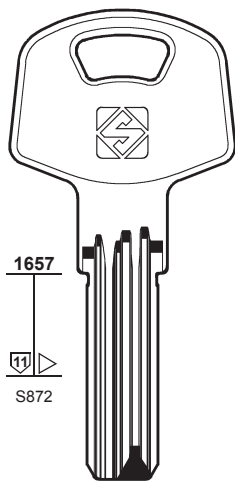

S872

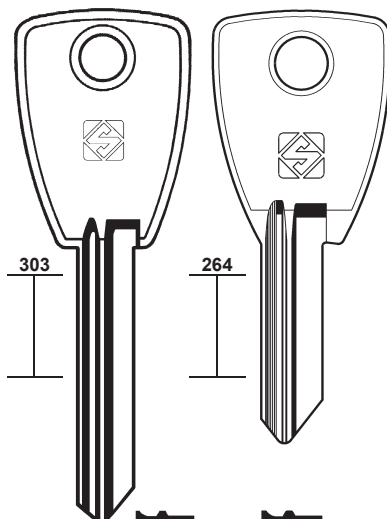

IS2

IS1

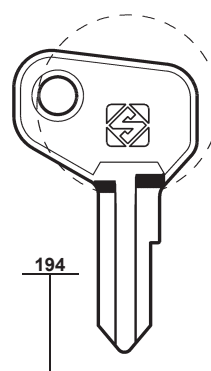

IJ1

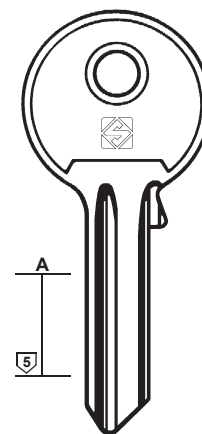

IL1R

IL1

PER:
FOR:

ILCO

ILLINOIS

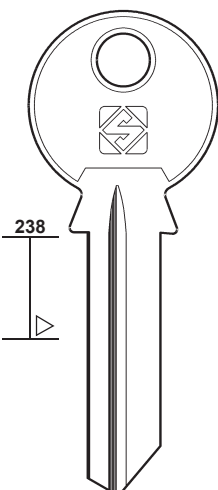

ILC13R

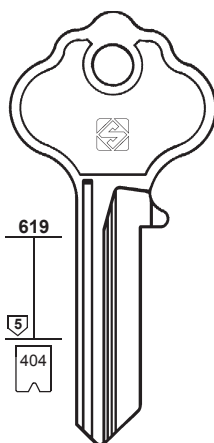

ILC2

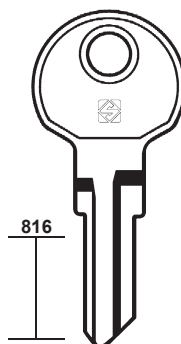

BARGMAN

ILC6

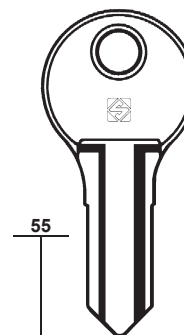

NUOVO PIGNONE
GRAYHILL - LAGRANGE
OTIS - SEEBURG

IN1

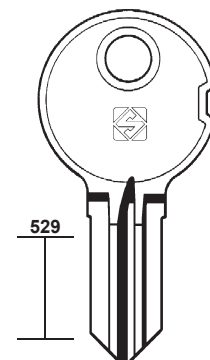

IN2

IN3

PER:
FOR: **ILLINOIS**

ILS

IMAB



107

PER / FOR

ILLINOIS (US)
+ CHICAGO (51)

ILS (IT)
+ FASEM (86)

IMAB (BR)

IMBAC (FR)
+ PREFER (158)

IMP (DE)
+ ABUS (8)

IMSI (IT)
+ PERINO (154)

INDAUX (ES)
+ FAC (84)

INDESIT (IT)
ELSI
MIT
RECA

INGERSOLL (GB)

INLOC (FR)
+ BRICARD (39)

INSA (IT)

INT (IT)

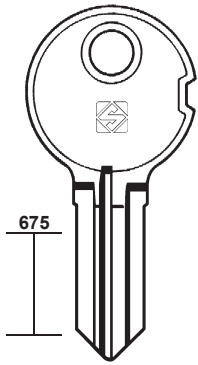

IN5

DUO

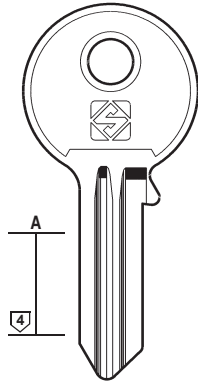

ILS1

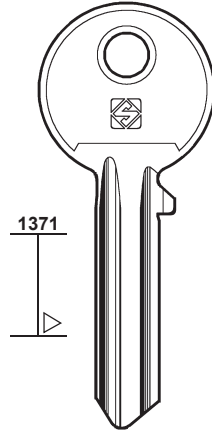

IAB7

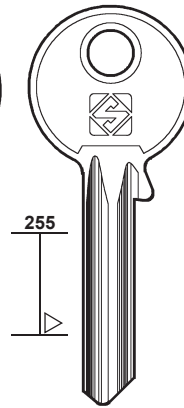

IAB8

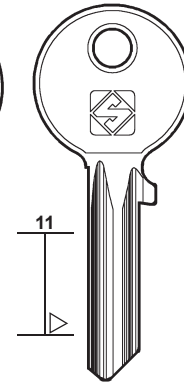

IAB9

PER:
FOR:

INDESIT

INGERSOLL

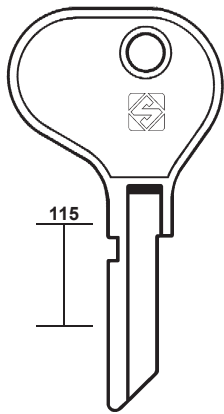

ID1
REG

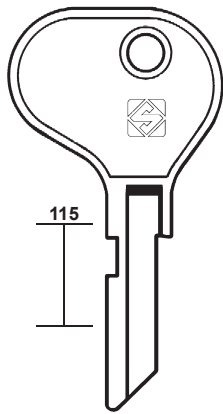

ID2
X

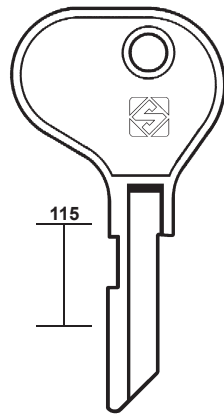

ID3
MGR



ELSI - MIT - RECA

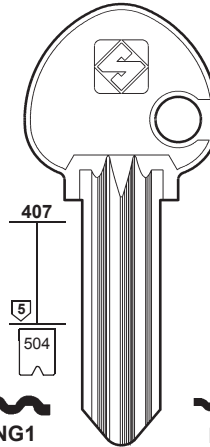

ING1
A... 1-2-3-4



ING5
S... 1-2-3-4



ING2
W



ING6
N



PER:
FOR:

INGERSOLL

INSA

INT

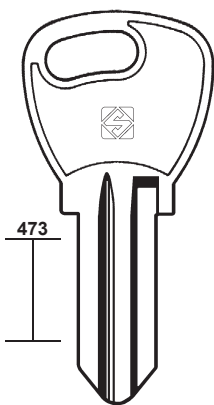

ING3

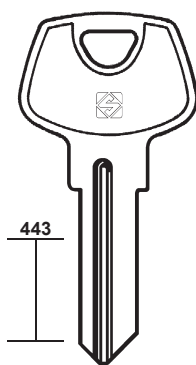

ING4R

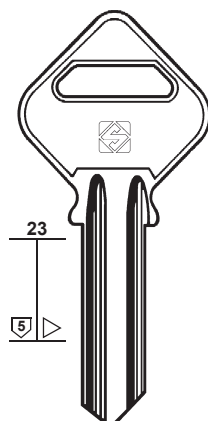

INS1



INS1R

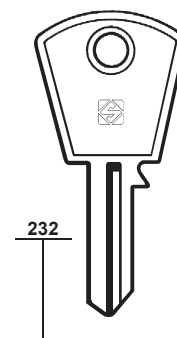

IT1



IT1R





108

PER / FOR

INT (IT)

I.R. (FR)

+ DOM (71)

+ W.M.S. (211)

ISABEL
FAINER'S (P)

ISEO (IT)

CAM
CITY
GERA
IFAM
STAR
VACHETTE

+ UCEM (192)

+ VACHETTE (198)

PER: INT

FOR:

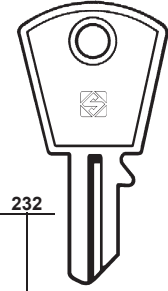

232



I.R.

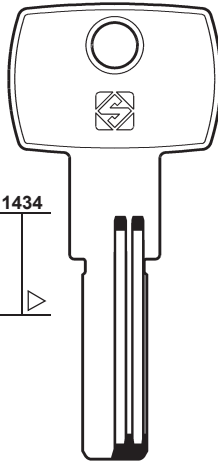

1434



ISABEL
FAINER'S

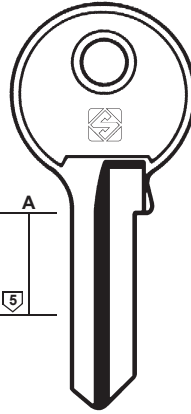

A



ISEO

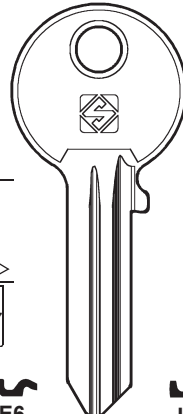

10



IE6
GERA - IFAM - STAR
..... 012345678
LCE 1-17513
Y 1-2000
Y0 1-2000

IE2
..... 1-2000
..... 0-1-2-3-4-5-6-7-8

IE6R
..... 012345678
KFC 1-28800
..... 1-6516

IE2R
.....
0-1-2-3-4-5-6-7-8

F3 IE31
F3 IE27R
.....
0-1-2-3-4-5-6-7-8-9



PER:
FOR:

ISEO

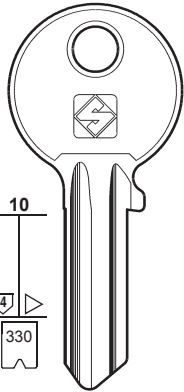

10



..... 0-1-2-3-4-5-6-7-8

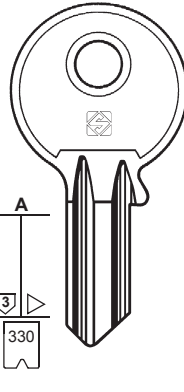

A



... 0-1-2-3-4-5-6-7-8

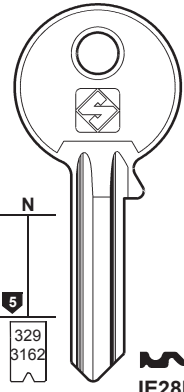

N



..... 1-2-3-4-5-6

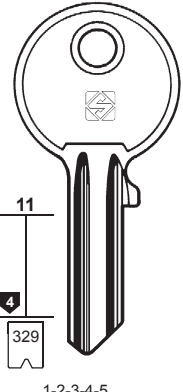

11



..... 1-2-3-4-5

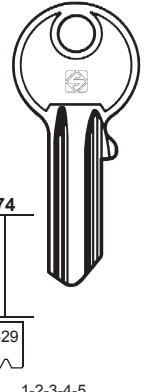

74



... 1-2-3-4-5



PER:
FOR:

ISEO

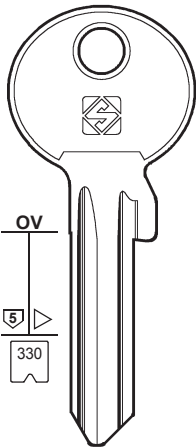

OV



IE6X
LCE 1-17513
Y 1-2000
Y0 1-2000
..... 012345678

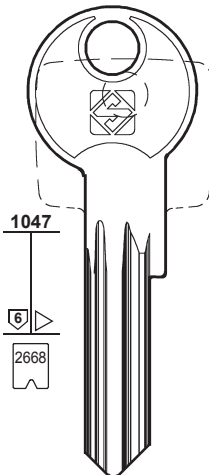

1047



IE29
A/Z A/Z A/Z 1-48568

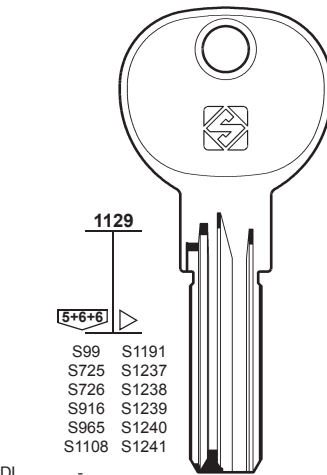

1129



S99 S1191
S725 S1237
S726 S1238
S916 S1239
S965 S1240
S1108 S1241

EDL
CFA 1-27065
EDL 1-350589
ECA 1-050000
ECA 100001-150000
EDA 1-350589
EDY 1-350612
EGE 1-027508
EGE 100001-127508
EGE 200001-227508



IE14
R11

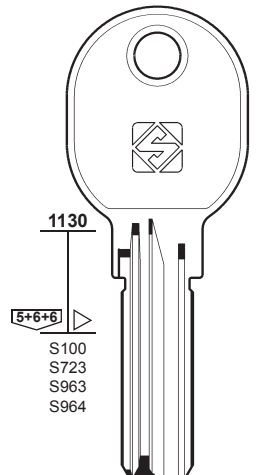

1130



S100
S723
S963
S964

ABL 1-015328
ACY 1-015328
AGL 1-015328
ABF 1-015694



IE15
R6



CITY - VACHETTE

PER:
FOR:

ISEO

Blue head
Testa blu



109

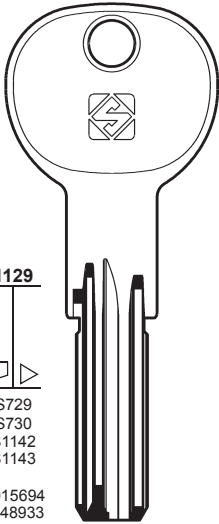

1129

5+6+6

S729
S730
S1142
S1143

AAC 1-015694
DAA 1-348933
AMB 1-012540
AMB 100001-112540



IE26



ATRA - CITY

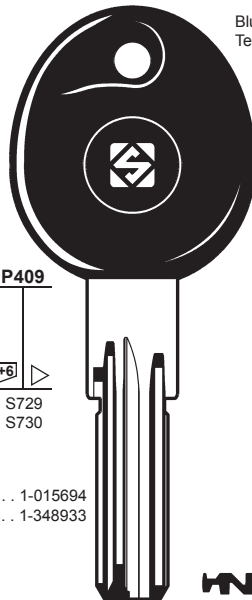

P409

5+6+6

S729
S730

AAC 1-015694
DAA 1-348933



IE26P

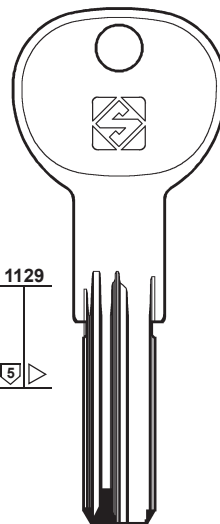

1129

5



IE30



PER / FOR

ISEO (IT)
ATRA
CITY
+ UCEM (192)
+ VACHETTE (198)

ISSERSTEDT (DE)
CORBIN (60)

ITALBLOCK (IT)
EUREKA (78)

ITO (TR)
CISA (55)
FTH (92)

ITOKI (JP)

IULIA MAS FED (IT)
FASEM (86)

IWATA (JP)

JÄBA (DK)

JAPAN (JP)

PER:
FOR:

ITO

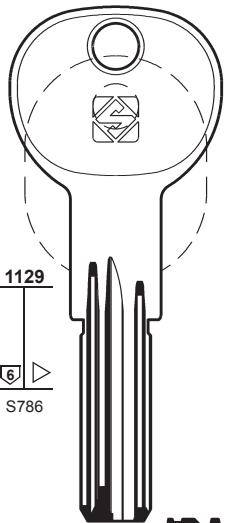

1129

6

S786



IO1

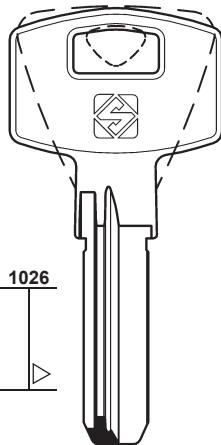

1026



IO2R



ITOKI

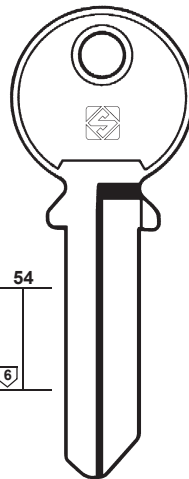

54

6



ITO1R



ITO2

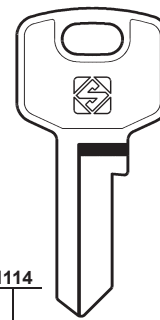

1114



ITO3



ITO3R

PER:
FOR:

IWATA

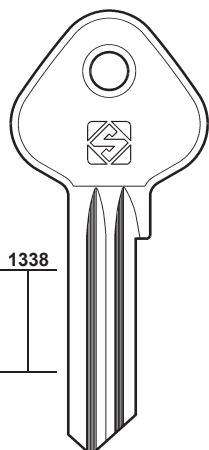

1338



IW1R

JÄBA

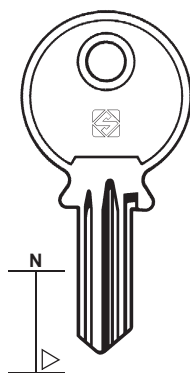

N



JB1

JAPAN

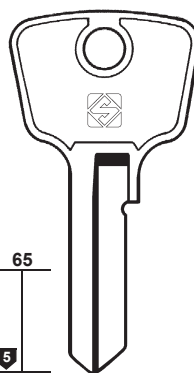

65

5



JPN1



JPN2

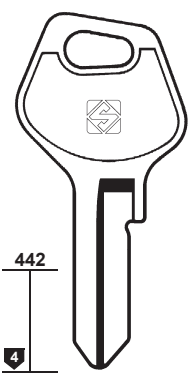

442

4



JPN3R



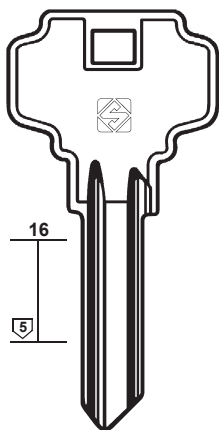
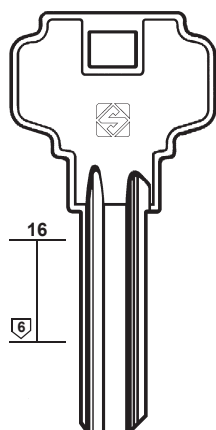
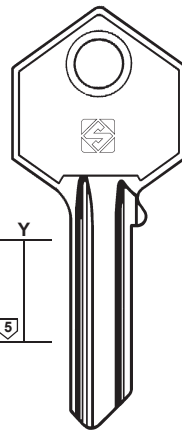

110

PER / FOR**JARDI (ES)****JD (JP)**
ALPHA (16)**JEHU (TW)****JET (DE)**
ABUS (7)**JIP (FR)**
PREFER (157)
RONIS (161)**JIS (ES)**
SEMEL**JL (FR)**
FTH (91)**JMR (ES)**
EZCURRA (82)**JNF (IL)**
EVERGOOD (80)**JOLY (FR)**
GABON (93)**JOMA (ES)**
IFAM (105-106)**JOE (DE)**
WILKA (210)**JOSTA (DE)**
CES (47)**JOWIL (DE)**
ESZ
FUHR
GTV
JÜNGST
MERCUR
OSKO
PANTHER
TIEFENTHAL
TRITON
VOKO
WEPA
+ EMR (77)
+ GTV (100)PER:
FOR:**JARDI**16
5
JAR1
JAR1R16
6
JAR2
JAR2R**JEHU**Y
5
JH1

mm 60

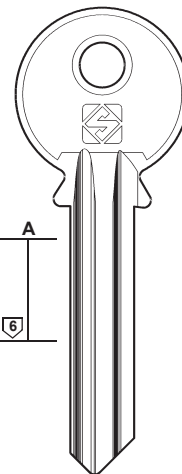
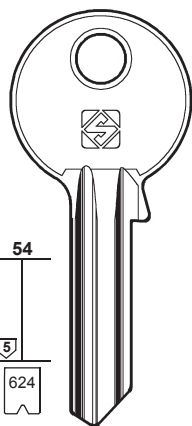
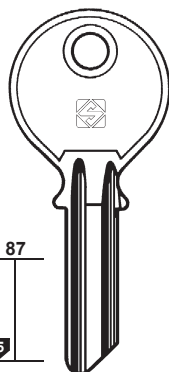
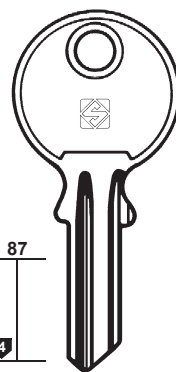
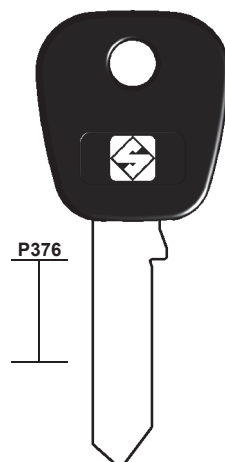
JISA
6
JS1
JS1RPER:
FOR:**JIS**54
5
624
JS2
JS2R87
5
JS4
JS4R87
4
JS3
JS3R

P376

JS5P

0-1-2-3-4-5-6-7-8-9

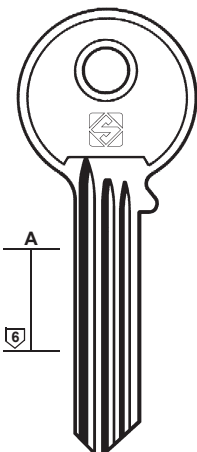
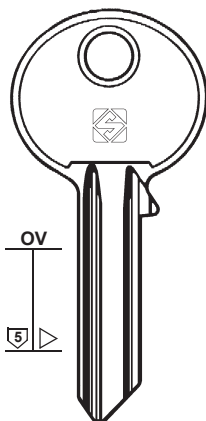
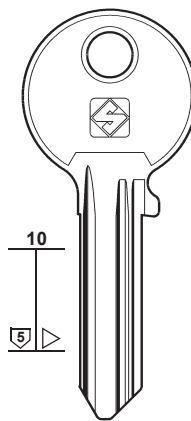
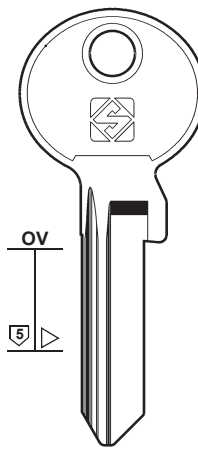
PER:
FOR:**JOWIL**A
6
JOW8OV
5
JOW1
JOW1R10
5
JOW2
JOW5
JOW6
JOW7
JOW9
JOW10
JOW11OV
5
JOW12X
JOW12RXESZ - FUHR - GTV
JÜNGST - MERCUR
OSKO - PANTHER
TIEFENTHAL
TRITON - VOKO - WEPA

PER:
FOR:

JOWIL

JPM

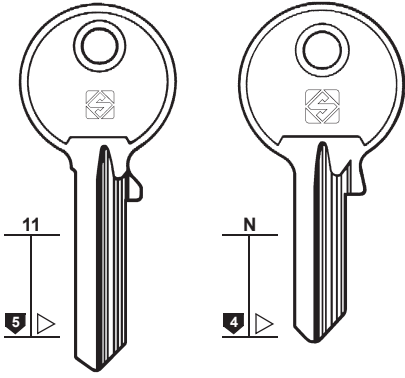

JOW3R

JOW4R

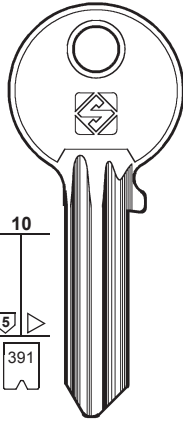

JM3
A
X
1-2-3-4-5-6-7

JM3R
 JM2
 JM2R

F3 JM1
AY
BA
BB
BC
BD
BL
BM
BN
BP
BQ
BR
BS
BT
BU
BY
F3C
SA
SB
1-6032

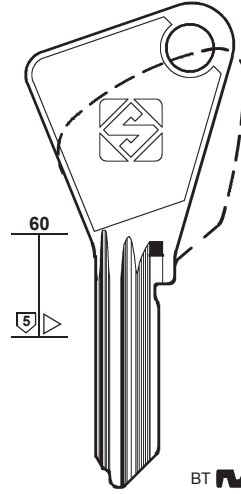

BT JM6

BK JM7



111

PER / FOR

JOWIL (DE)
+ EMR (77)
+ GTV (100)

JPM (FR)
+ ABUS (6-7)
+ CISA (56)
+ KESO (115)
+ SIMECA (170)

JTF (FR)
IJ
+ IJ (106)
+ MERONI (137)

JU (DE)
+ KIFERM (117)
+ VACHETTE (198)

JUNGHEINRICH (DE)

JUNGHWA (JP)

JÜNGST (DE)
 JOWIL (110)

JUNIE (DE)

PER:
FOR:

JTF

JU

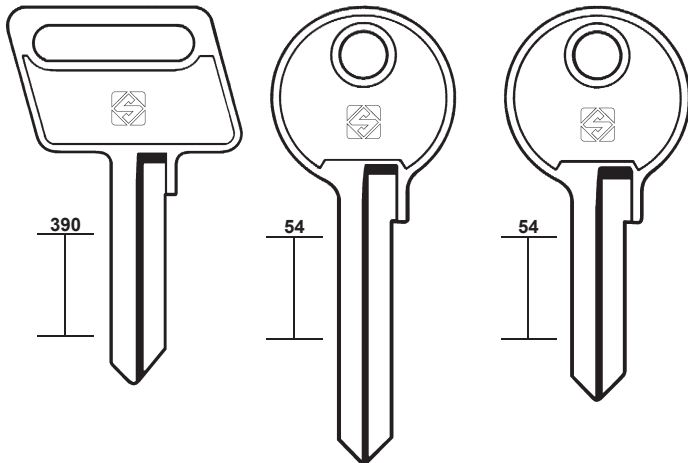

JT1
JA

JT2R

JT3R

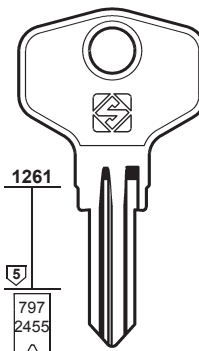

JU11
D (A) 1-2-3
B ... (D) 376-500+(507-508)

JU12
C (B) 1-2-3
B ... (C) 251-375+(505-506)

JU11R
A (D) 1-2-3
B ... (A) 001-125+(501-502)

JU13R
B (B) 126-250+(503-504)



PER:
FOR: **JUNGHEINRICH**

JUNGHWA

JUNIE

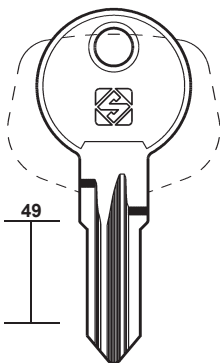

JR1R

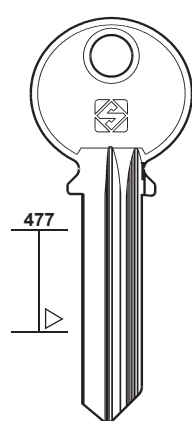

JN1R

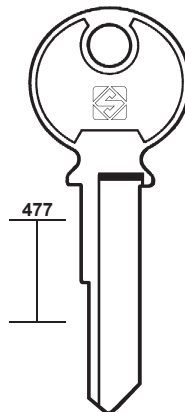

JU5

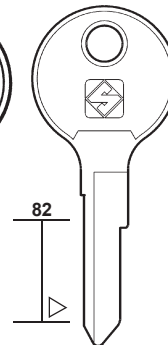

JU9

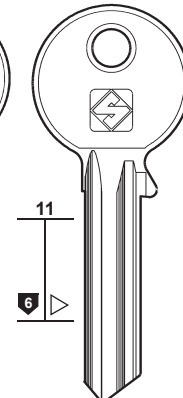

JU3

JU6

JU4

JU8

JU14





112

PER / FOR

JUNIE (DE)
PEROHAUS
VS

JUNKUNC (US)
ALSO
AMERICAN
FEDERAL
LION

JUWEL (IT)
+ FASEM (86)

JVAL (PT)
FEB
P.C.
SAVIO
+ P.C.
(CORTELLEZI) (153-154)

PER:
FOR:

JUNIE

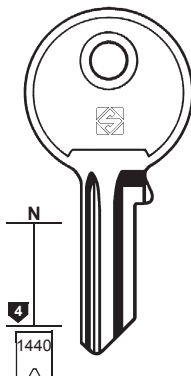
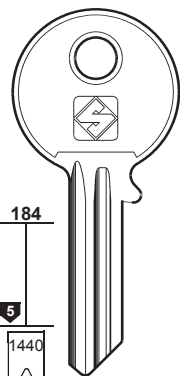

JU2



JU2R



JU1



JU1R

..... 0-1-2-3-4-5-6-7
NN 2001-2998



JU7



JU10

..... 0-1-2-3-4-5-6-7



PEROHAUS - VS

JUNKUNC

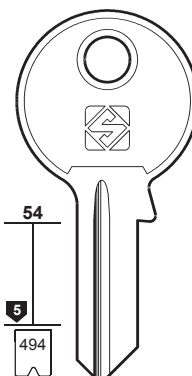
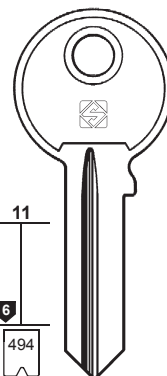

..... 80000-88999

..... 1-2-3-4-5-6-7-8



JC2R



JC1



ALSO - AMERICAN - FEDERAL - LION

PER:
FOR:

JUWEL

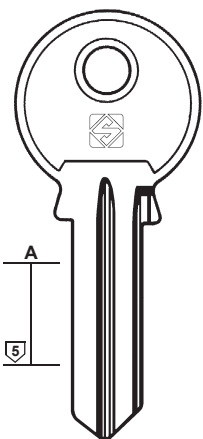

JW13
16



JW13R
15



JW12



JW10



JW10R



JW9
52



JW9R
53



JW8
51



JW4
1



JW4R
2



JW7
9



JW7R
10



JW5
3



JW5R
4



JW6
5



JW6R
6

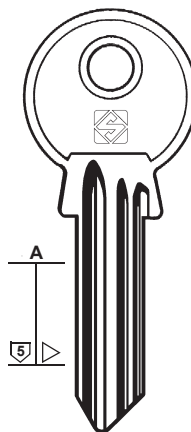

JW1R

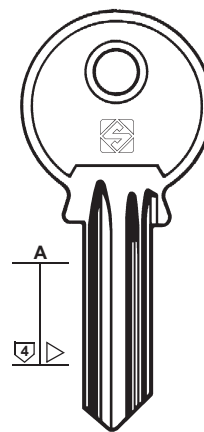

JW2R



JW1



JW2

PER:
FOR:

JUWEL

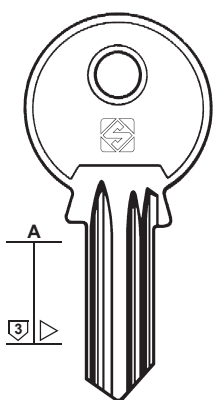

JW3

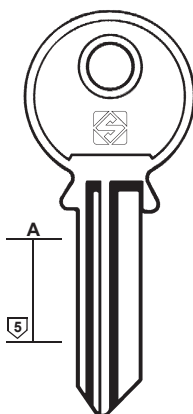

JW11

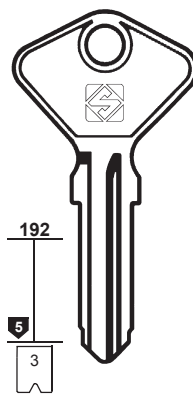

AF4C
6...
100-309



AF4D
8...
100-309

JVAL

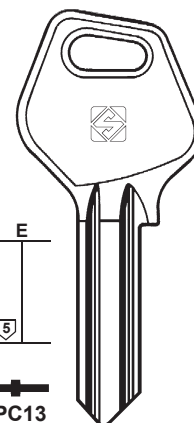

PC13



VL5E



VL5RE



JL3



JL3R

FEB - P.C. - SAVIO

PER:
FOR:

JVAL

KABA

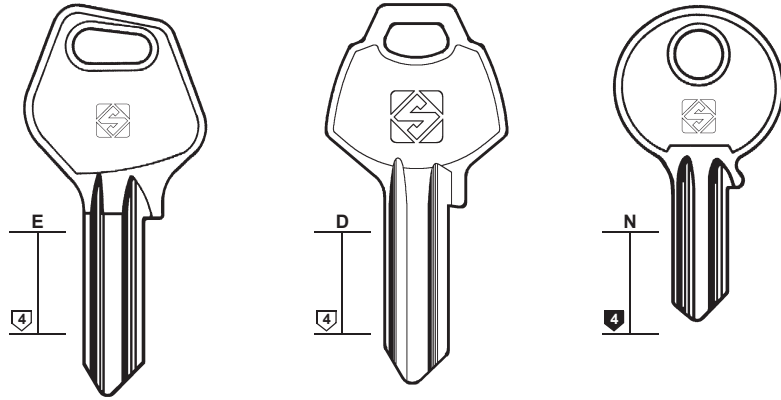

FEB - P.C.

FEB

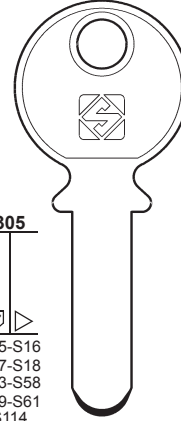

305

17

S15-S16
S17-S18
S53-S58
S59-S61
S114

PH ...
0001-9000
... 1-200



113

PER / FOR

JVAL (PT)
FEB
P.C.
+ PC.
(CORTELLEZI) (153-154)

KABA (CH)
BORKEY
DORSET
LÄSBOLAGET
PICARD

KAIXI (CN)

PER:
FOR:

KABA

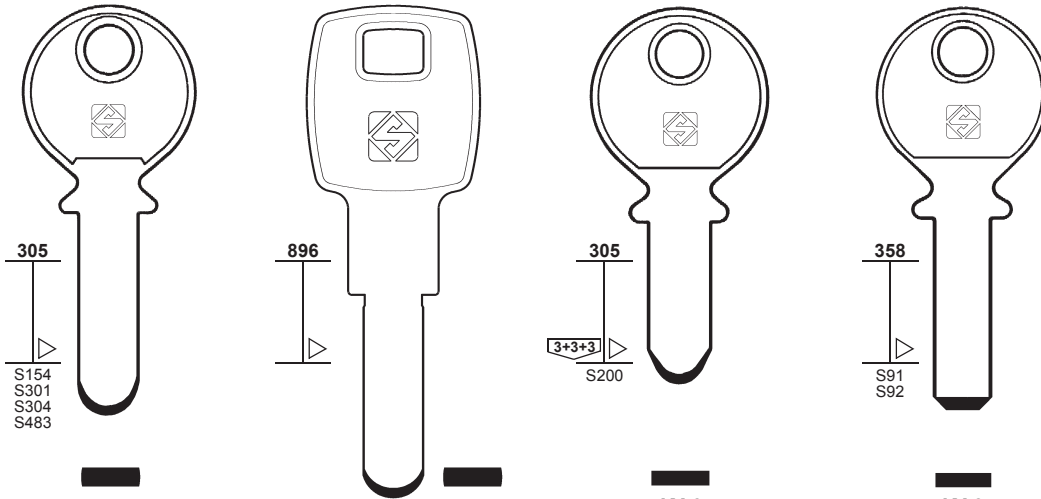

305

896

305

358

S154
S301
S304
S483

3+3+3
S200

S91
S92

KA2
20

KA7

KA6

KA3
MINI KABA



PICARD

BÖRKEY



PER:
FOR:

KABA

KAIXI

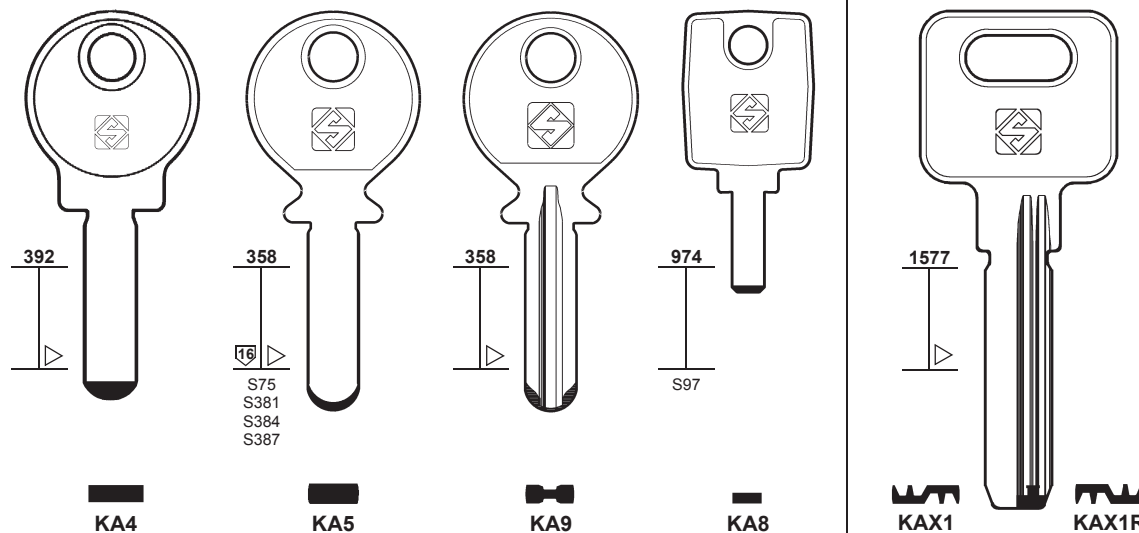

392

358

358

974

1577

16

S75
S381
S384
S387

S97

KA4

KA5
GEMINI

KA9

KA8
MICRO KABA

KAX1

KAX1R



DORSET





114

PER / FOR

KAKEN (KR)

KALE (TR)

- + ABUS (7)
- + BUVA (44)
- + TESA (182)

KALUGA (RU)

KARDEX (FR)

- + CES (47)
- + RONIS (161)
- + VINCO (205)

KARO (ES)

- + FTH (92)

KASPIJSK (RU)

KATE (DE)

- + SIMECA (170)

KAWE (DE)

- + CORBIN (60)
- + TESA (181)
- + WEISER (208)

PER: **KAKEN**

FOR:

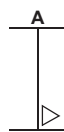
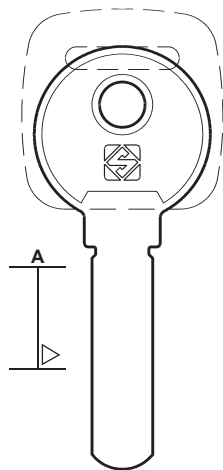

KAK1



PER: **KALE**

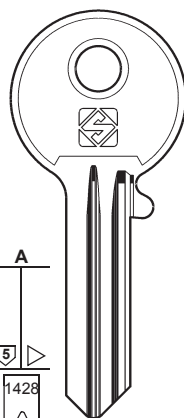

KLE3R

..... 1-2-3-4-5-6-7-8-9

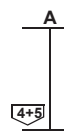
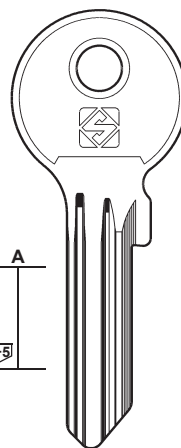

KLE3X

KLE5X



KLE3RX

KLE5RX

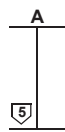
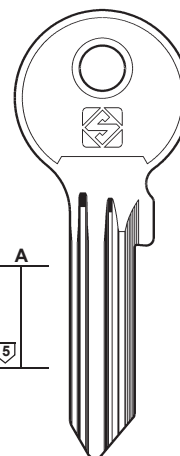

KLE6X

KLE7X

KLE6RX

KLE7RX

PER: **KALE**

FOR:

KALE

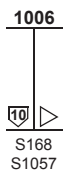
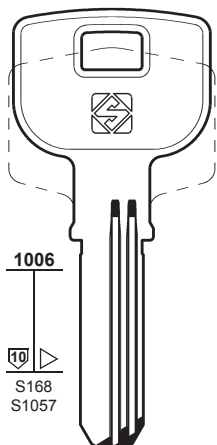

S168
S1057

KLE1

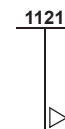
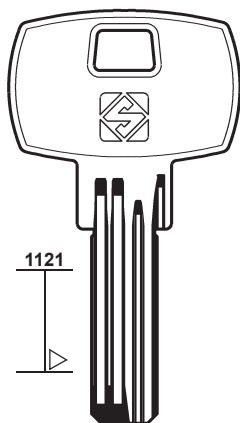

KLE2R

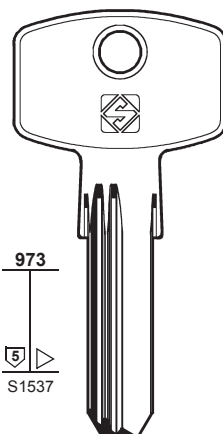

S1537

KLE8R

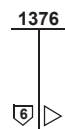
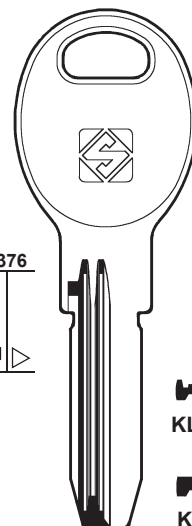

S1537

KLE10R

KLE9R



PER: **KALE**

FOR:

KALE

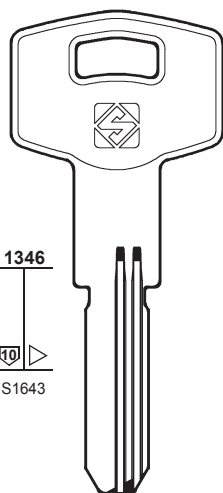

S1643

KLE11



KALUGA

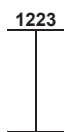
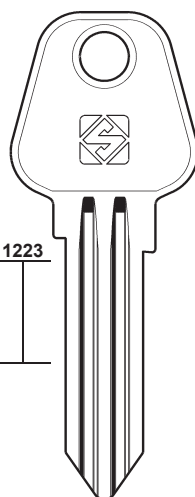

KLG1R

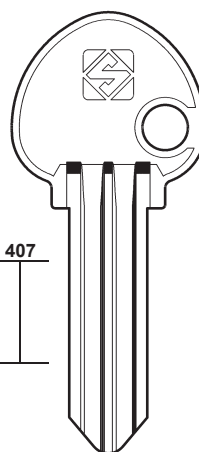

KLG2R

RUS2

KASPIJSK

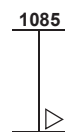
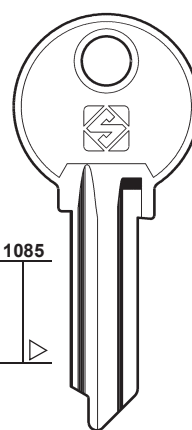

KAP1

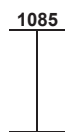
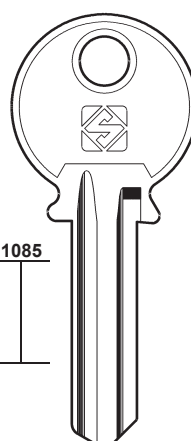

KAP1R

RUS1

RUS1R

PER:
FOR:

KAZAN

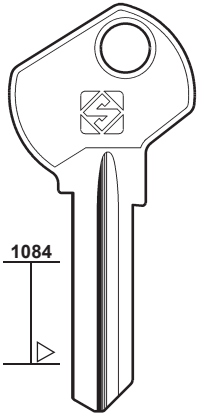

1084

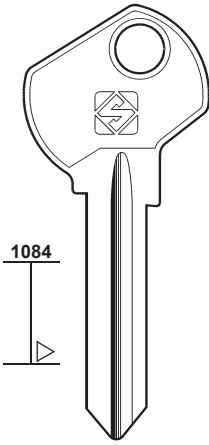

1084

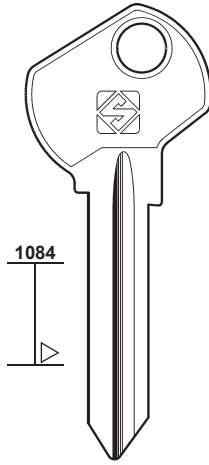

1084

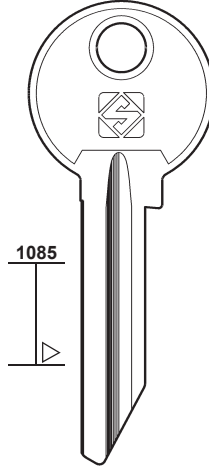

1085

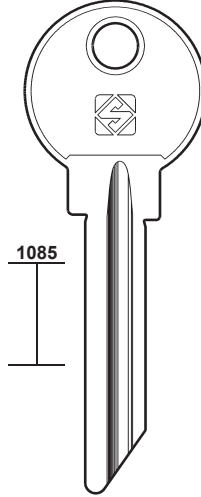

1085



115

PER / FOR

KAZAN (RU)

KEIL (US)

KESO (CH)

ALA

JPM

LIPS

SARGENT

PER:
FOR:

KAZAN

KEIL

KESO

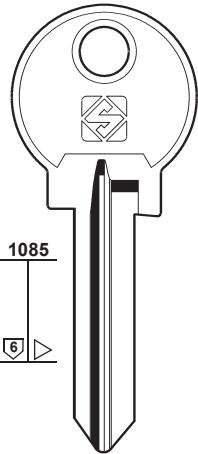

1085

6

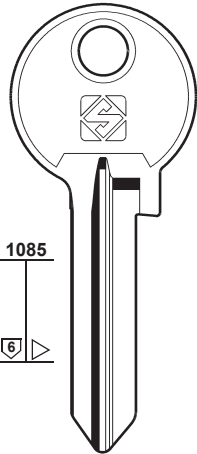

1085

6

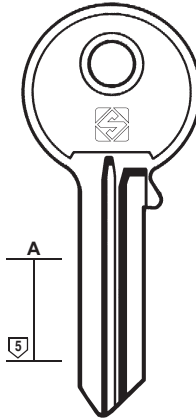

A

5

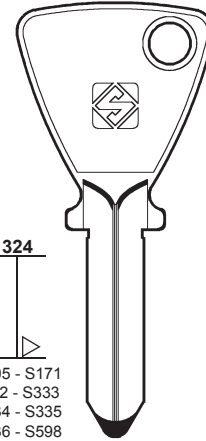

324

S105 - S171
S332 - S333
S334 - S335
S336 - S598
S599 - S600
S601 - S678
S259 - S807



JPM

PER:
FOR:

KESO

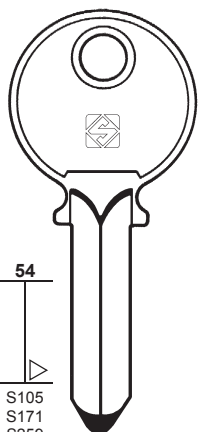

54

S105
S171
S259
S332
S333
S334
S335
S336
S598
S599
S600
S601



JPM

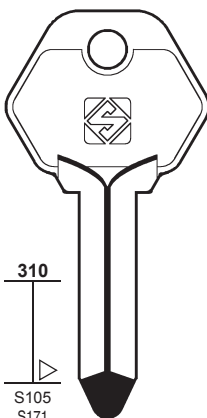

310

S105
S171
S259
S332
S333
S334
S335
S336
S598
S599
S600
S601



SARGENT



LIPS

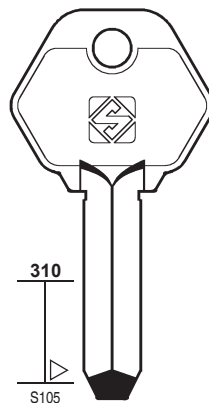

310

S105

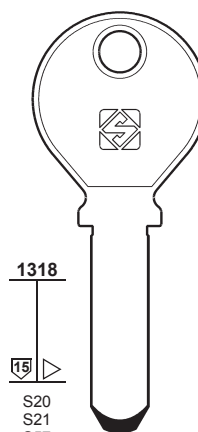

1318

S20
S21
S57
S267
S273
S277
S359
S1298



ALA

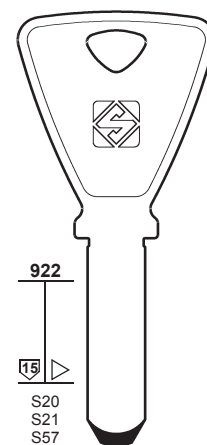

922

S20
S21
S57
S267
S273
S277
S359
S663
S1298



JPM



116

PER / FOR

KESO (CH)
FIAM

KEYA (ES)
+ MELSMETALL (136)

KEYRACK (DE)

KFV (DE)
COMBA
FCV
FLIETHER
GIESCHE
GÖTZ
GRAF
HSA
NICO
SCHÜCO
SEN

KHARKOV (UA)

PER:
FOR:

KESO

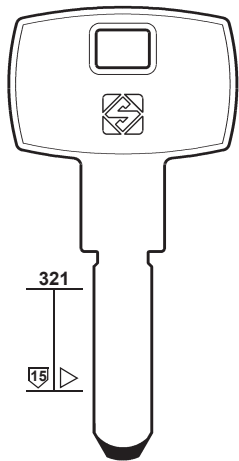

KE11

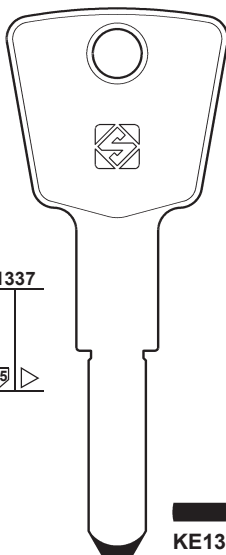

KE13

FIAM

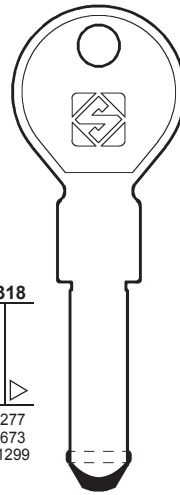

KE19

2000 S Omega
2000 S (STEP-DRILLING)



KEYA

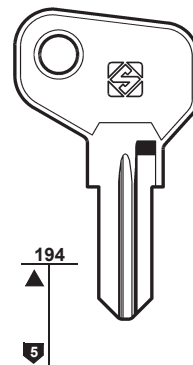

KEY1

KEY1R

PER:
FOR:

KEYA

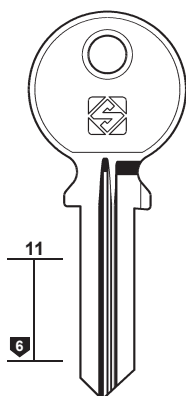

KEY2

KEYRACK

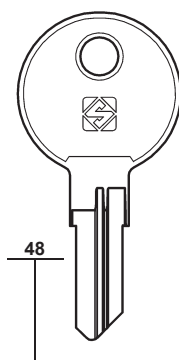

KER1

KFV

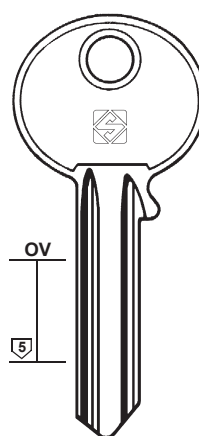

KF1

- | | |
|--|--|
| | |
| | |
| | |
| | |
| | |
| | |
| | |
| | |
| | |
| | |

COMBA - FCV - FLIETHER
GIESCHE - GÖTZ - GRAF - HSA
NICO - SCHÜCO - SEN

PER:
FOR:

KHARKOV

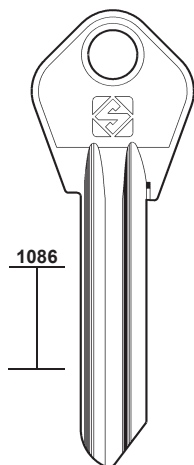

HAK1

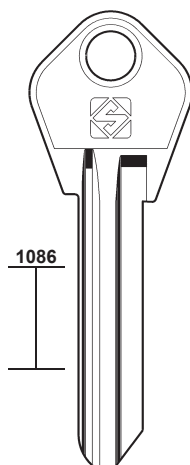

HAK2 HAK6

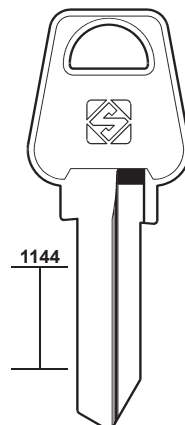

HAK3

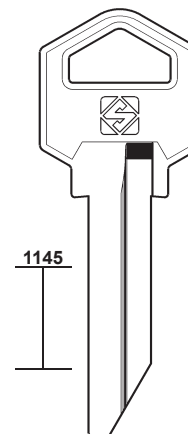

HAK4

PER:
FOR:

KIENZLE

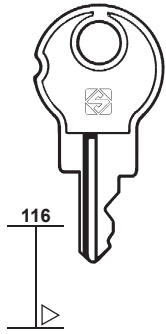

KZ1

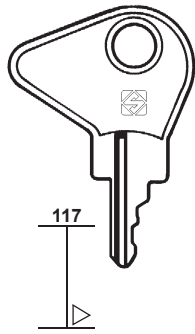

KZ2
1

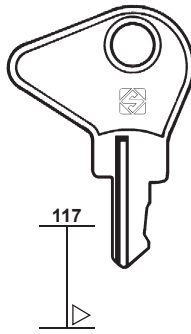

KZ3
2

VDO

KIEV

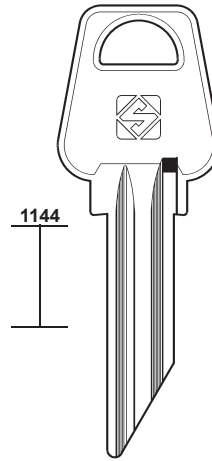

MTZ1

METIZ



117

PER / FOR

KIENZLE (DE)
VDO

KIEV (UA)
METIZ

KIFERM (FR)
ATAL
CASH-BOX
DEF
GB
HÄFELE
IJN
JU
LAS
METEOR
ORDO
RENZ
SEIM
TEEN HAAF
WESCO
+ LAS (121)
+ RICOUARD (160)

KILT (FR)
VACHETTE (198)

KIMA (DE)
CES (47)

KIND (DE)
CES (47)
HOPPE (103)

PER:
FOR:

KIFERM

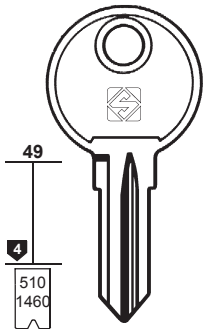

KI4
... 1-50
... 167
X ... 167

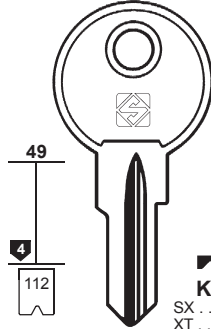

KI5R
SX ... 1-275
XT ... 1-75
RX ... 1-275

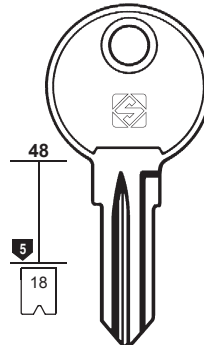

KI8 **KI8R**
W ... 1-224 Z ... 1-224

KI12 **KI12R**
... 151-218 ... 1-68
... 101-150 ... 51-100
... 1116-7776 H ... 500-574
H ... 1116-7776 E ... 1116-7776
E ... 425-499

KI7
XY ... 1-275

KI7R

ATAL - IJN - JU
LAS - METEOR
RENZ - TEEN HAAF

KI10 **KI10R**
Y ... 1-224 C ... 1-224
 CA ... 1-224
DEF - GB
LAS - ORDO

PER:
FOR:

KIFERM

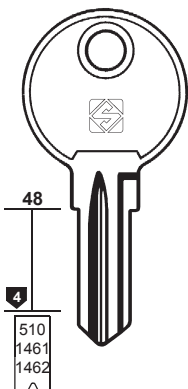

KI9 **KI9R**
... 226-293 ... 76-143
... 1-2-3 CASH-BOX
F ... 80-130
... 258

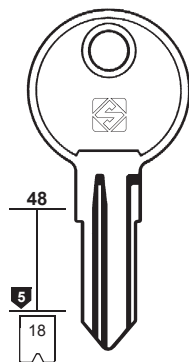

KI13
P ... 1-224

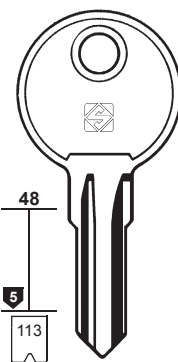

KI16
EX ... 1-224

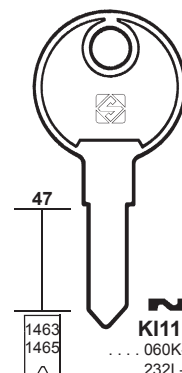

KI11R
... 060K-K660
... 232L-L332

KI14 **KI11**
TL ... 1-50 ... 232K-K332

KI15 **KI15R**
S ... 1-20 T ... 1-20

DEF - HÄFELE
LAS - WESCO

LAS



LAS

SEIM



118

PER / FOR

KING (TW)

KIROVSMACH (RU)

KISHINEV (MD)

KITTY (TW)

ABLOY (4)

K+K (IT)

TAMPALINI (179)

KKL (AT)
WB

KMF (GR)

KNAPP (DE)
 CES (47)

KNAUS (GB)

EURO LOCKS (80)

KOBE (RU)

KOPAT (ex YU)

KÖNIG (DE)

VIRO (205)

KOVER (DE)

EMKA (77)

KP (RU)

KRAMATORSK (UA)

KREMENCHUK (UA)

KROST (DE)

BUS (44)

KUNERT (DE)

CISA (57)

KURZEMES (LV)

AISPUTE (13)

PER: FOR:	KING	KIROVSMACH	KISHINEV	
	 132 54 KG1 KG2	 1302 KIR1	 1088 1088 KIV1R KIV2R	
PER: FOR:	KKL	KMF	KOBE	KOPAT
	 10 KL1 KL1R KL2 KL2R WB	 A KM1 KM1R	 1085 KOB1	 454 KP1
PER: FOR:	KP	KRAMATORSK	KREMENCHUK	
	 1102 KPP1	 1141 KMT1 KMT2R	 1087 KRE1	

PER:
FOR:

KVR

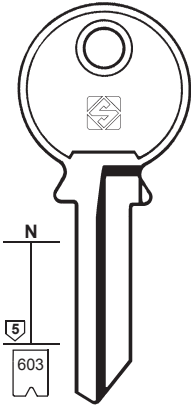

CA9

CAP - PROTEC

KWIKSET

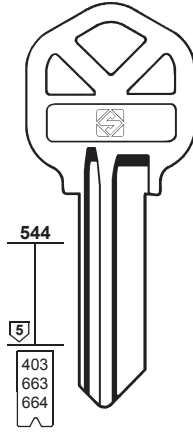

KS1

0-1-2-3-4-5-6-7
1-2-3-4-5-6-7
1-2-3-4-5-6-7-8-9

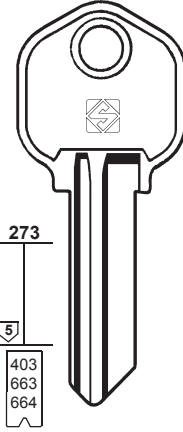

KS1FT

0-1-2-3-4-5-6-7
1-2-3-4-5-6-7
1-2-3-4-5-6-7-8-9

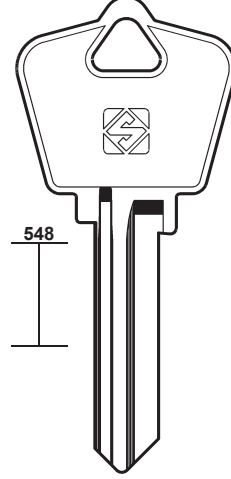

KS4

BRICARD - E-Z-SET - MASTER - VACHETTE



119

PER / FOR

KVR (DE)
CAP
PROTEC

KWIKSET (US)
BRICARD
E-Z-SET
MASTER
VACHETTE

KYNNARPS (GB)

KYR (IT)
SECURITAL (167)

LABOFA (NL)
GEGE (94)

LADA (RU)

LA FONTE (BR)

PER:
FOR:

KYNNARPS

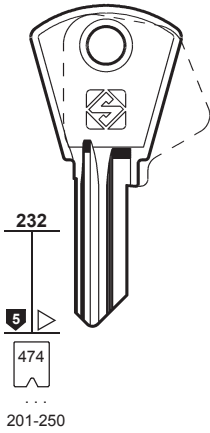

KNA1

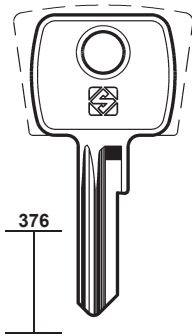

KNA2

LADA

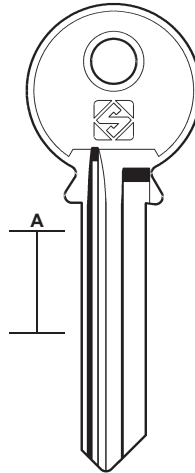

LD4

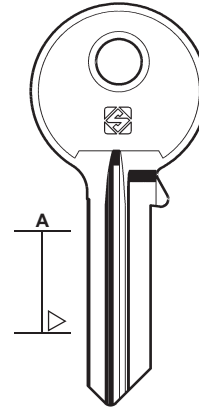

LD4R

LD5R

PER:
FOR:

LA FONTE

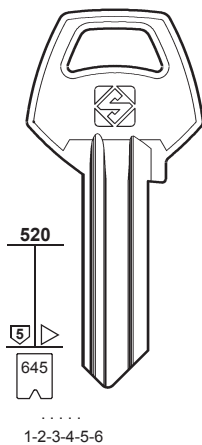

LAF1

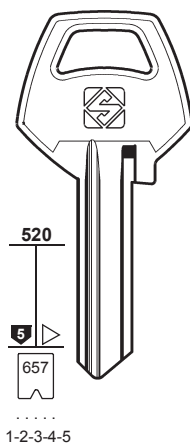

LAF2

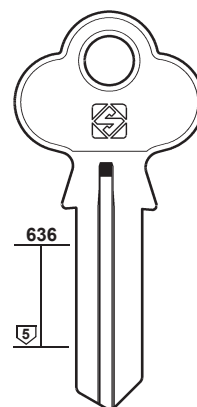

LAF4R



120

PER / FOR

LA FONTE (BR)

LAGRANGE (US)

+ ILLINOIS (106)

LAMA (ex YU)

+ MERONI (136)

+ TITAN (183)

LAMPA (US)

+ CEMA (46)

LANE (AU)

+ CORBIN (62)

LAPERCHE (FR)

+ CAS-CISMA (45)

+ DOM (68)

+ RONIS (161)

PER:
FOR:

LA FONTE

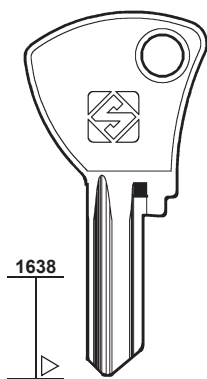

1638



LAF5

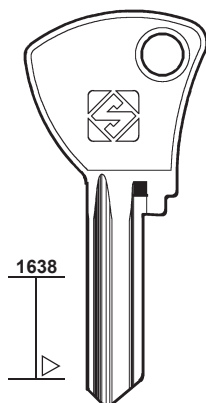

1638



LAF6

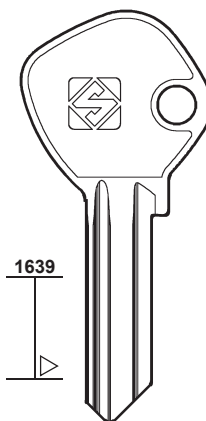

1639



LAF7

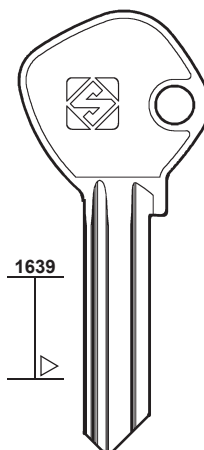

1639



LAF8

PER:
FOR:

LAMA

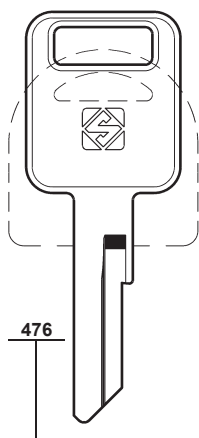

476



LMA1



LAPERCHE

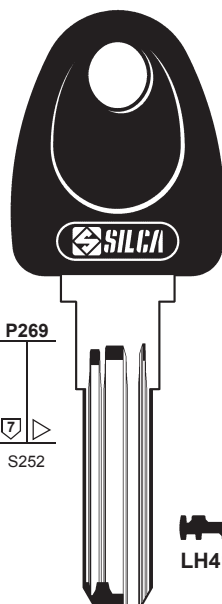

P269

S252



LH41P

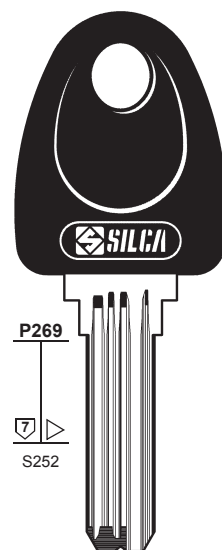

P269

S252



DIAM



LH13P



LH16P



LH14P



LH17P



LH15P



LH18P

PER:
FOR:

LAPERCHE

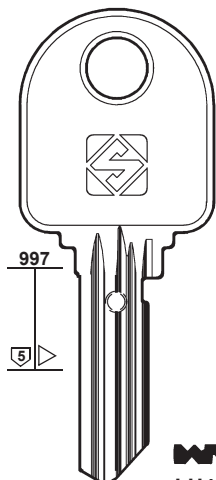

997



LH43R

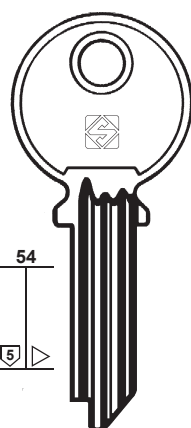

54



LH1
DM

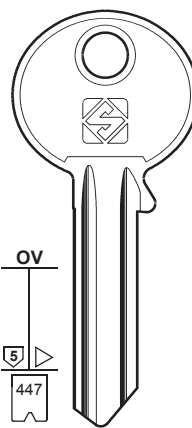

OV

447



LH4

C0 ... 1-1000
C1 ... 1-1000
C2 ... 1-1000
C3 ... 1-1000
B0 ... 1-1000
B1 ... 1-1000
B2 ... 1-1000
B3 ... 1-1000

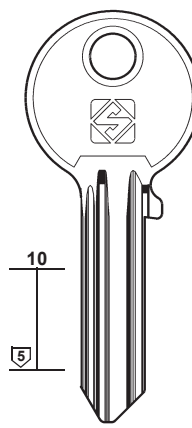

10



LH40

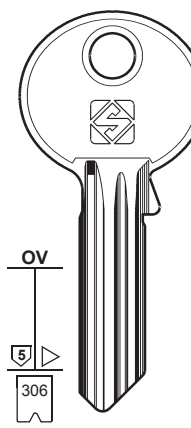

OV

306



LH42
L0 ... 1-9999

PER:
FOR:

LAPERCHE

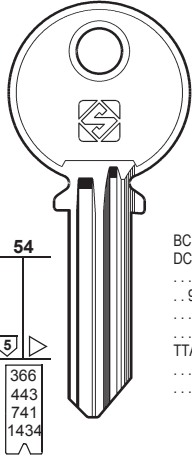

LH5
..... 0-1-2-3-4-5-6-7-8-9
..... 1-2-3-4-5-6-7-8-9
TTP 0-1-2-3-4-5-6-7-8-9
... 9 ... 1-2-3-4-5-6-7-8-9

LH5R

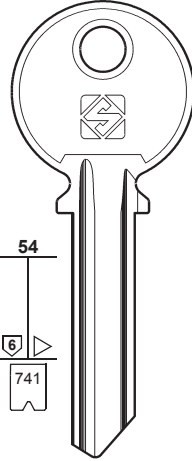

LH10
..... 0123456789
UUP
0123456789

LH10R



121

LH20
..... 0-1-2-3-4-5-6-7-8-9
TTR
0-1-2-3-4-5-6-7-8-9

LH2
BC 1001-3865
DC 1001-3865
..... 1-2-3-4-5-6-7-8-9
... 9 ... 1-2-3-4-5-6-7-8-9
..... 15001-16000
..... 16001-18125
TTA 0-1-2-3-4-5-6-7-8-9
..... 13001-13500
..... 1001-3865

LH7R
..... 1-2-3-4-5-6-7-8-9

LH21
..... 0-1-2-3-4-5-6-7-8-9
TTS
0-1-2-3-4-5-6-7-8-9

LH22
..... 0-1-2-3-4-5-6-7-8-9
TTT
0-1-2-3-4-5-6-7-8-9

LH25
UUR
0-1-2-3-4-5-6-7-8-9

LH26
UUS
0-1-2-3-4-5-6-7-8-9

LH3
UUA
0-1-2-3-4-5-6-7-8-9

LH27
UUT
0-1-2-3-4-5-6-7-8-9

LH28
UUV
0-1-2-3-4-5-6-7-8-9

LH29
UUX
0-1-2-3-4-5-6-7-8-9

PER:
FOR:

LA PORTE

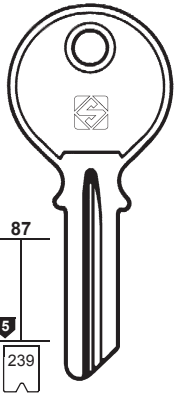

..... 7200-7399
..... 1001-1052

LAP1

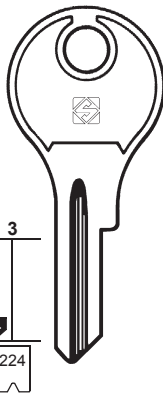

..... 2501-2550

DL1R

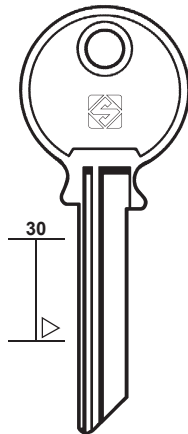

LAP3

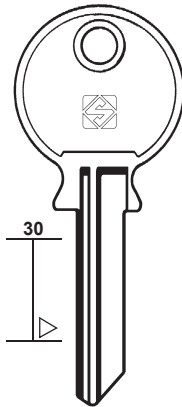

LAP2

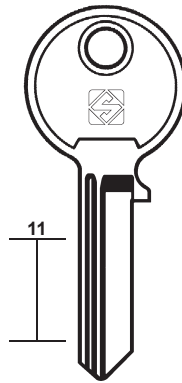

DL3

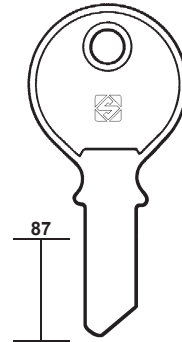

DL2



GHE - PRESTA



DLP

PER:
FOR:

LAS

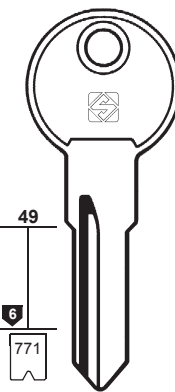

A ... 1-650

LS3

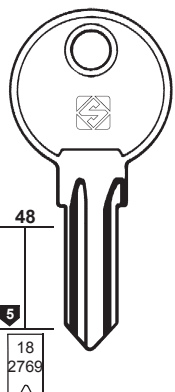

R ... 1-224

LS1

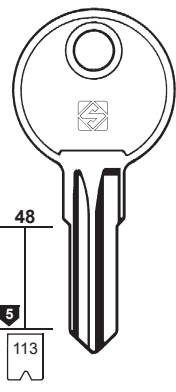

AX ... 1-224

LS2

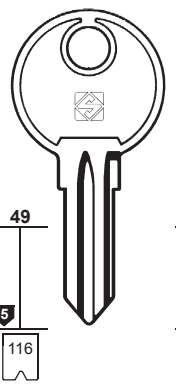

FH ... 1-400
LH ... 1-400
FH ... 501-550

LS7

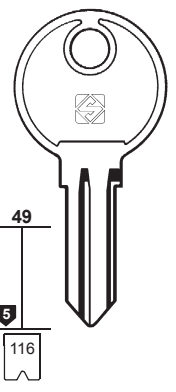

FH ... 1-400
LH ... 1-400
FH ... 501-550

LS19

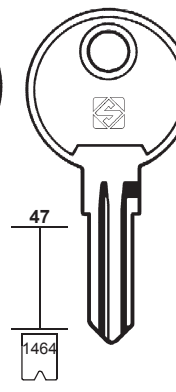

LS ... 1-60

LS12

LS10
AB



DUBOIS - KIFERM
PK - RENZ
RONIS - WESCO



ATAL - HÄFELE
KIFERM
MARCADET - RENZ

LS4
U

LS4R
X

STRAFOR

PER / FOR

LAPERCHE (FR)
+ CAS-CISMA (45)
+ DOM (68)
+ RONIS (161)

LA PORTE (DE)
DLP
GHE
PRESTA
+ BOMORO (37)
+ DLP (67)

LAREDO (ES)
+ YALE (212)

LARK (TW)
+ GLOBE (97)

LAS (FR)
ATAL
DUBOIS
HÄFELE
KIFERM
MARCADET
PK
RENZ
RONIS
STRAFOR
WESCO
+ KIFERM (117)
+ RICOUARD (160)



122

PER / FOR

LAS (FR)

ABBES
FORT
MARCADET
ORDO
RONIS
+ KIFERM (117)
+ RICOUARD (160)

LÅSBOLAGET (SE)

TANLOCKS
+ KABA (113)
+ SIS (170)

LAUDON (ZA)

L & F (129)

LBLM (ES)

FORTIS (90)

LE FEBURE (US)

CIFIAL (53)

LEGALLAIS (FR)

HB

LEGG (GB)

LEHMANN (DE)

MLM
+ MLM (141)

LEN-LOK (AU)

ROLL-A-DOOR
+ LOCKWOOD (126)

LG (FR)

ARROW (20)

PER:
FOR:

LAS

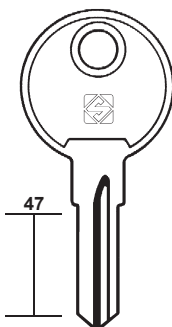

LS5
L

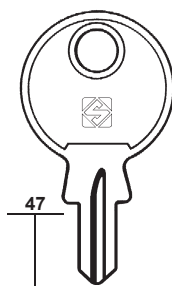

LS6
L231

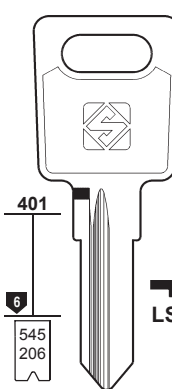

LS9
AT... 1-650

PR
LS17

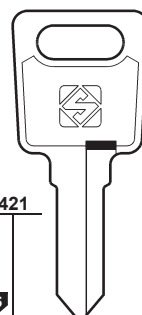

LS14
MJ... 1-400
FM... 1-100
SM... 1-400
MR... 001-050
FM... 501-550
SM... 501-550

LS13

JH... 1-100
FH... 1-400
LH... 1-400
SH... 1-400
WH... 1-400
AA... 1-50
LH... 1-60
... 301-675
FH... 501-500

FORT

LS13R
FM
SH...
501-550

LS14R

LS18
PM... 1-10

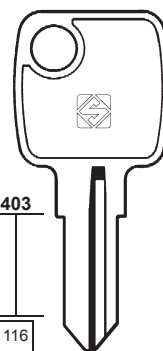

LS15

MARCADET - RONIS

ABBES - ORDO

PER:
FOR:

LÅSBOLAGET



4
590
.....
6543210

LB28

LB29

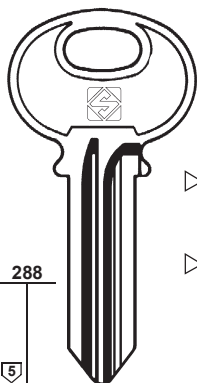

5
591
.....
X09876V

LB11

LB19

LB23

LB33

LB35

LB10

LB18

LB22

LB32

LB34



TANLOCKS

TANLOCKS

PER:
FOR:

LEGG

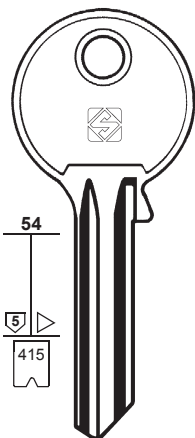

..... 1-2-3-4-5-6-7

LEG1

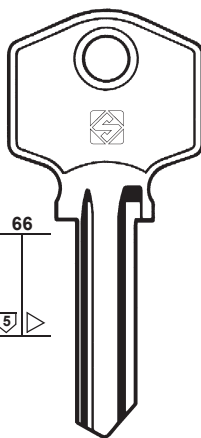

LEG2

LEG3
PASSEPARTOUT

LEHMANN

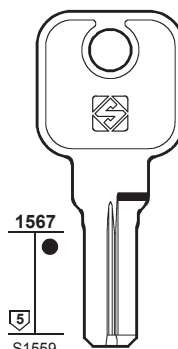

S1559

MLM9



MLM

LEN-LOK

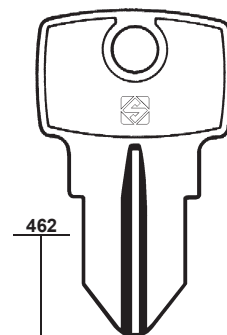

LL1
LL

ROLL-A-DOOR

PER:
FOR:

LINCE

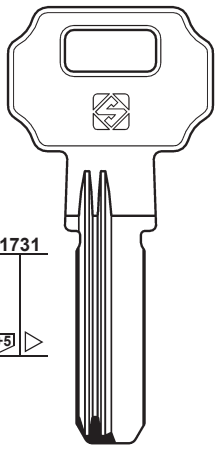

LC26R

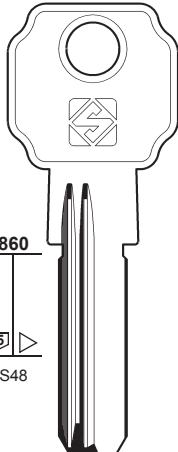

LC14R
X

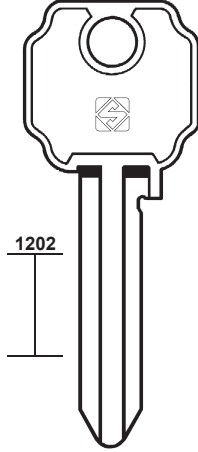

LC10
K

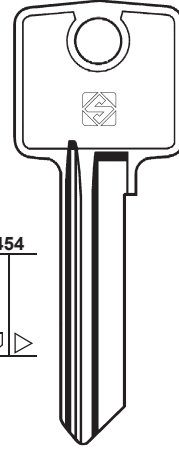

LC7
M

LC7R
M

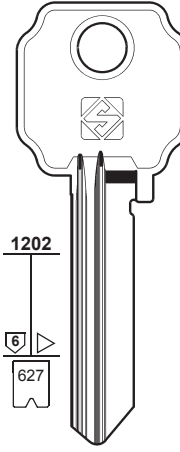

LC15
S

LC15R
S

.....
1-2-3-4-5-6-7-8



123

PER / FOR

LINCE (ES)
ICSA
+ ALPHA (16)

LION (US)
JUNKUNC (112)

LIONA-LIOX (FR)
RONIS (161)

PER:
FOR:

LINCE

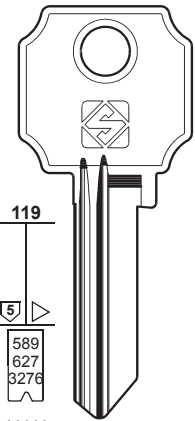

.....
1-2-3-4-5-6-7-8

LC1
A

LC1R
A

LC2
C

LC2R
C

LC11
R

LC11R
R

LC12
B

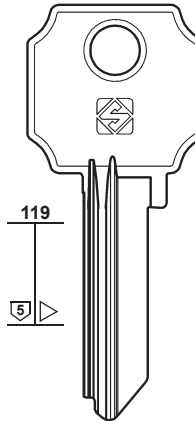

LC25

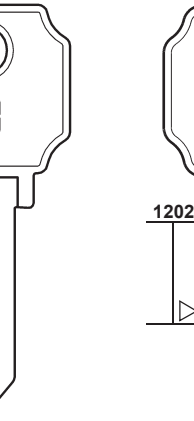

LC25R

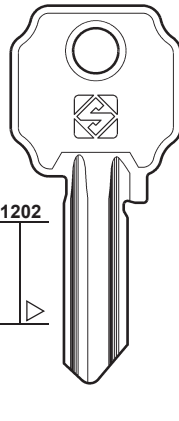

LC16
U

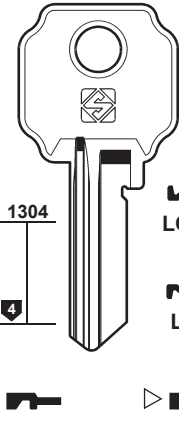

LC13R
D1

LC13
D1

LC8
T

LC3
D

LC8R
T

LC3R
D



PER:
FOR:

LINCE

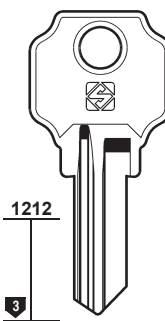

LC17R

LC17

LC9

LC4
E

LC9R

LC4R
E

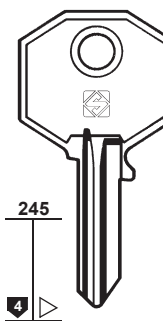

LC6
J

LC6R
J

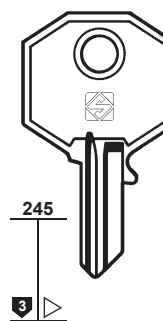

LC5
F

LC5R
F





124

PER / FOR

LIPS (NL)
+ DALWA (64)

PER:
FOR:

LIPS

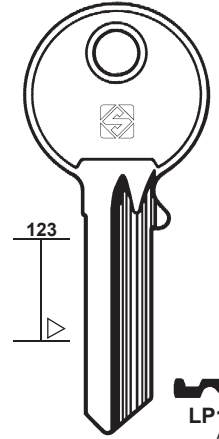
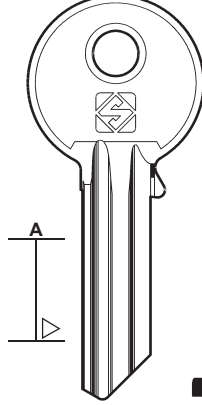
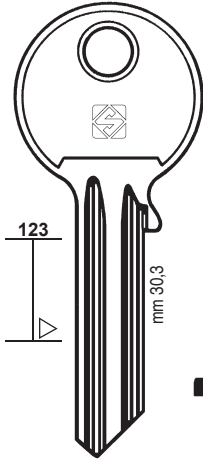

PER:
FOR:

LIPS

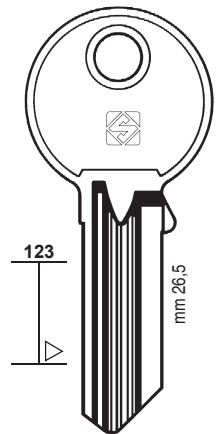
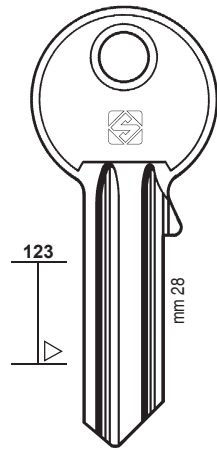
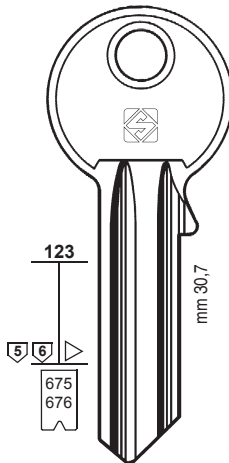

.....
1-2-3-4-5-6-7-8-9-0
A-B-C-D-E-F-G-H-I-L

PER:
FOR:

LIPS

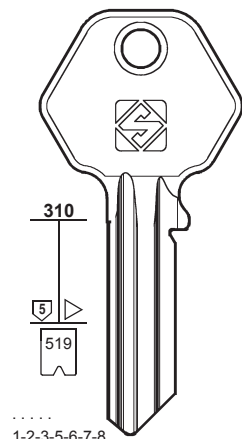

.....
1-2-3-5-6-7-8

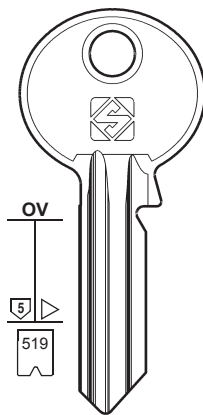

.....
1-2-3-5-6-7-8

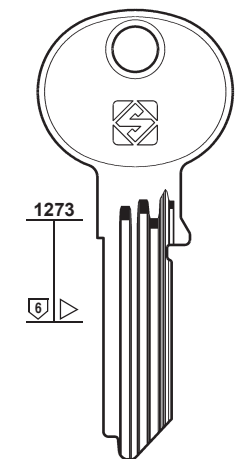
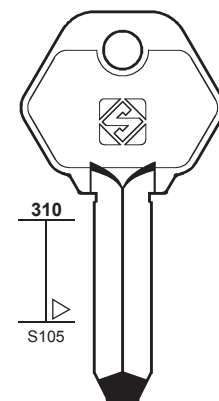

PER:
FOR:

LIPS

LITTO



125

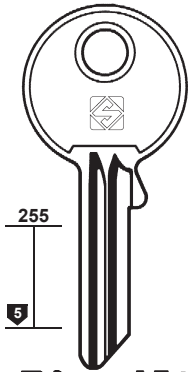

LP14
19

LP14R
18

LP15
21

LP15R
20

LP16
17

LP16R
16

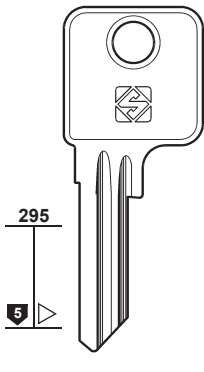

LP6

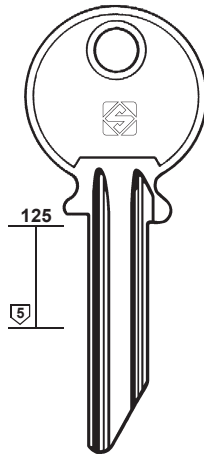

LT1

BKS

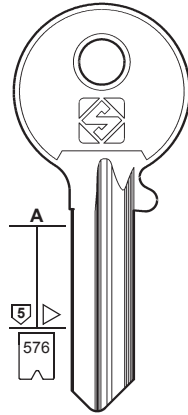

LT2
E

00E001-05E999

1-2-3-5-6-7-8-9-0

ANKERSLOT

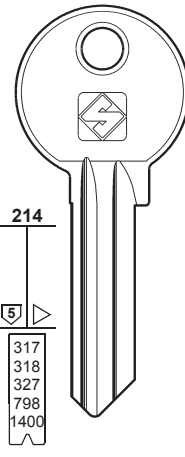

CB6

..... 012345678

..... 123456

DX 123456

..... 123456789

..... 876543210

CORBIN

PER / FOR

LIPS (NL)

+ DALWA (64)

LIPS-VAGO (IT)

+ PREFER (157)

LISTA (DE)

+ DOM (69-70)

LITTO (BE)

ANKERSLOT

BKS

CORBIN

+ ANKERSLOT (17)

+ CORBIN (60)

LM (SE)

+ TEKA (181)

L.M.C. (DE)

+ HUWIL (104)

LML (IT)

+ MORI E. (142)

LN (BR)

LOB (PL)

ROSTEX

+ FAB (82)

+ MCM (134)

PER:
FOR:

LITTO

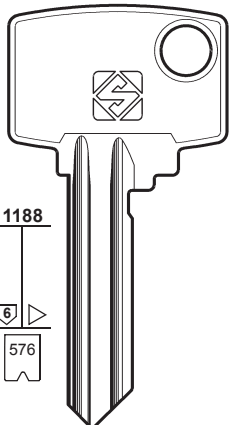

LT3

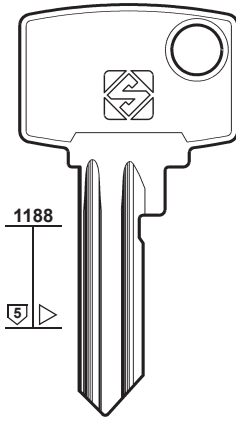

LT4

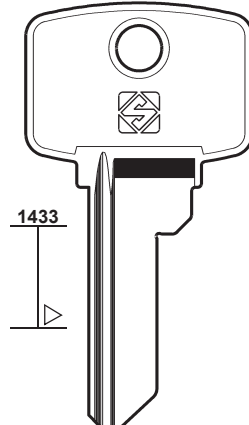

LT5

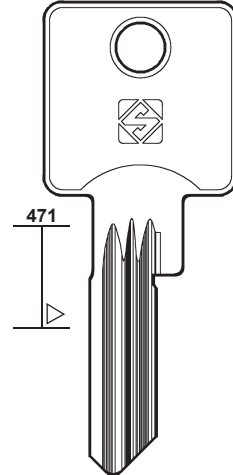

LT6R

PER:
FOR:

LN

LOB

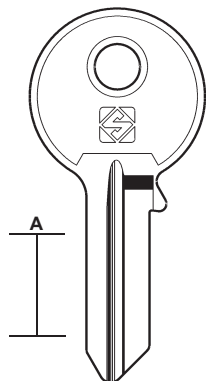

LN1

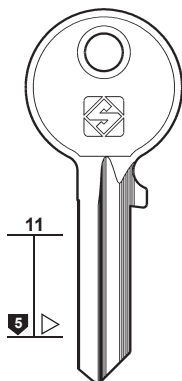

LOB1

LOB1R

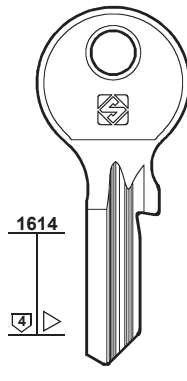

LOB9R

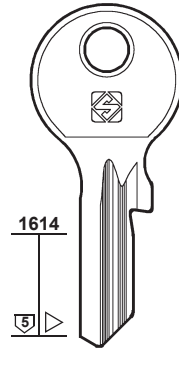

LOB10R

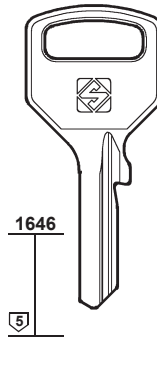

LOB11R

ROSTEX



126

PER / FOR

LOB (PL)
BRICARD
EXPRES
REDY
YETI

+ FAB (82)
+ MCM (134)

LOCKSYS (BG)

LOCKWELL (BR)

LOCKWOOD (AU)
LEN-LOK

PER:
FOR:

LOB

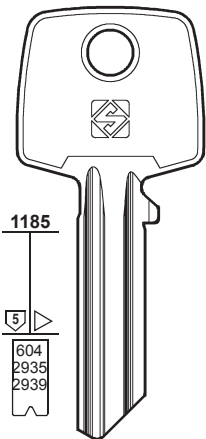

..... 0123456789
..... 123456789ABC



LOB16

YETI

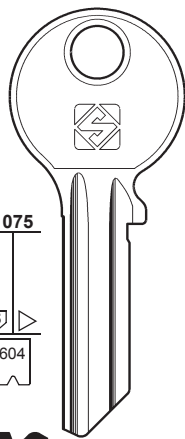

YT16



YT15



YT15R

..... 0-1-2-3-4-5-6-7-8-9

**BRICARD - EXPRES
REDY - YETI**

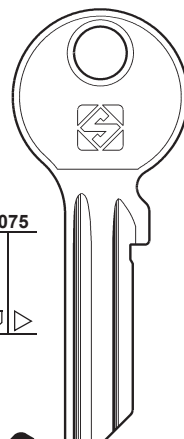

YT16X



YT15X



YT15RX

YETI

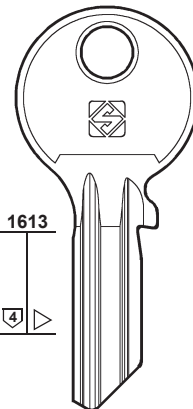

LOB13

PER:
FOR:

LOCKSYS

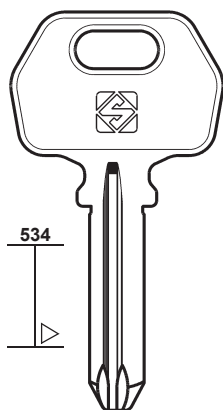

LCK1R

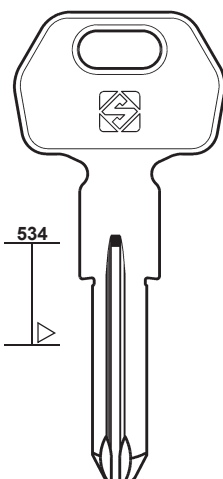

LCK1RX



LOCKWELL

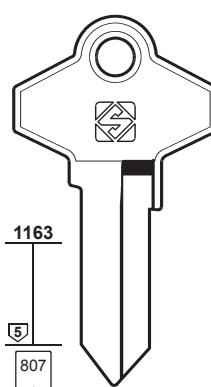

..... 1-2-3-4-5-6-7-8



LOC1

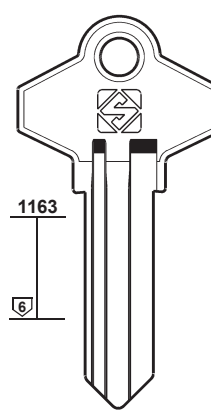

LOC3

PER:
FOR:

LOCKWELL

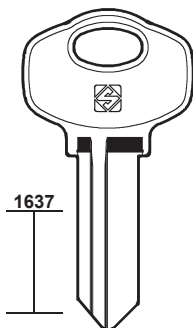

LOC4

LOCKWOOD

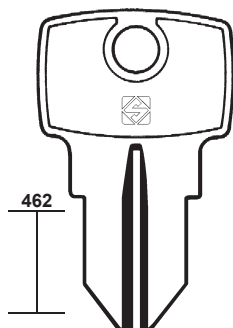

LL1
LL

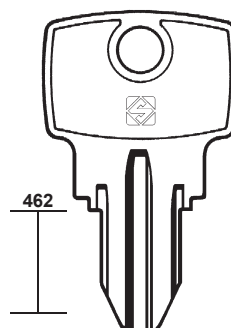

LW16
R



LW17
N

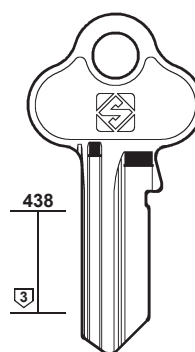

LW34

LEN-LOK

PER:
FOR:

LOCKWOOD



127

PER / FOR

LOCKWOOD (AU) (US)
GAINSBOROUGH

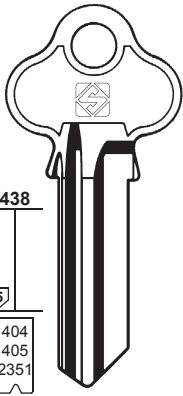

LW4
..... 0123456789A
B ... 1-100
C ... 1-100
D ... 1-100
E ... 1-100
A ... 1-40
FG ... 1-826

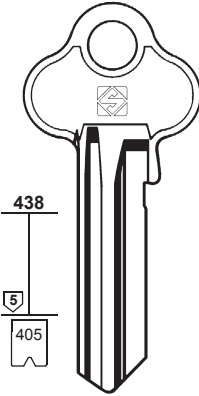

LW4R
..... 0123456789A

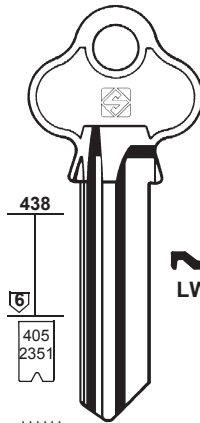

LW6 AB
LW7 AC
LW8 AD
LW9 AE
LW10 BC
LW11 DE

LW20
..... 0123456789
X ... 100-27787
HX ... 1000-1500

LW20R
..... 0123456789

LW40
LW40R
0-1-2-3-4-5-6-7-8-9-A

LW5
LW5R
..... 0123456789A
B ... 1-100
D ... 1-100
F ... 1-100
A ... 1-40
C ... 1-40

GAINSBOROUGH

PER:
FOR:

LOCKWOOD

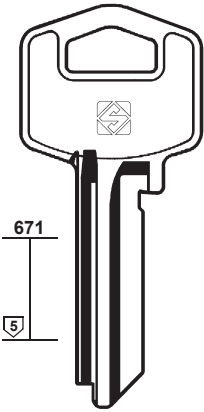

LW18

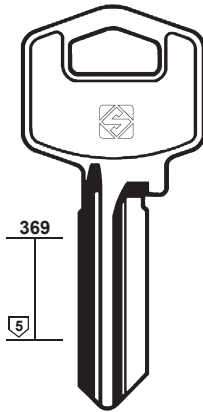

LW19

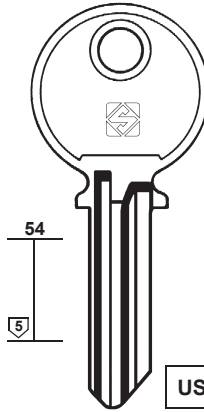

LW2 **LW2R**

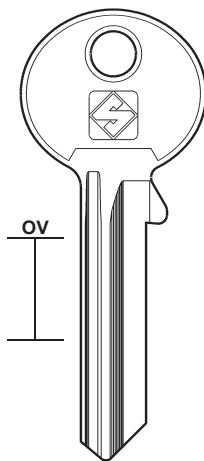

LW24

PER:
FOR:

LOCKWOOD

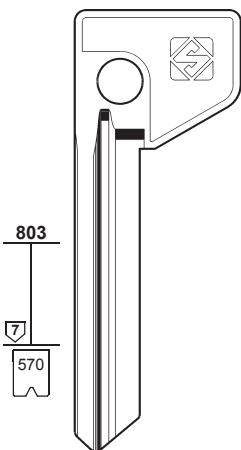

LW21R
.....
0-1-2-3-4-5-6-7-8-9-A

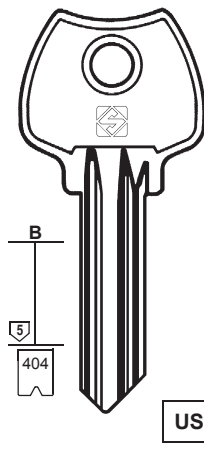

LW1 **LW1R**
.....
0-1-2-3-4-5-6-7-8-9

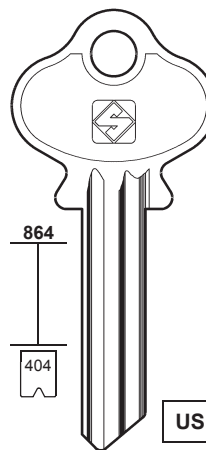

LW23
..... 0123456789

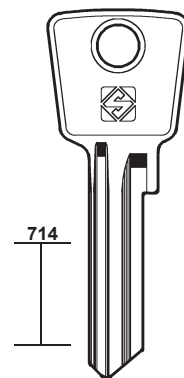

LW28
..... 1-3720
..... 3001-6720
..... 456789A





128

PER / FOR

LOCKWOOD (AU) (US)

LOGO (IT)

+ CISA (55-57)

LOK 2000 (IT)

+ CISA (57)

LORI (US)

+ EAGLE (75)

LOTUS (TW)

+ YETI (218-219)

L & F (GB)

ATAL
DAD
DOUBLE SAFE
EURO LOCKS
IBFM
MIBRA
TELFORD
ULTRA
UTZ
+ CHICAGO (52)
+ EURO LOCKS (78-79)

LOCKWOOD

PER:
FOR:

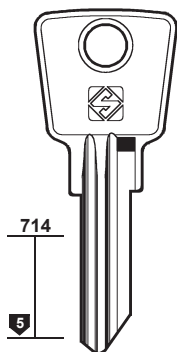

LW14
24A

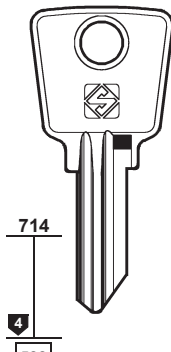

LW3
... 1-960
L... 1-960
L... 151-250

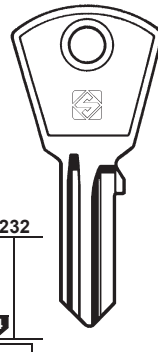

LW15
... 1-2100

LW13
CL ... 1-1000

LW12R
Y ... 1-960



LOK 2000

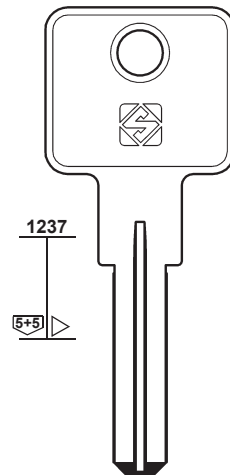

LOK2



LOWE & FLETCHER

PER:
FOR:

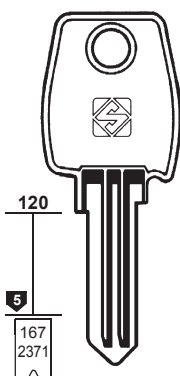

LF2
G ... 1001-5000
... 31001-32000
... 31001-33000
... 32001-33000
... 36001-38000
... 38001-38999
... 77001-77500
... 87001-91000
... 95000-99000
... 5001-9000

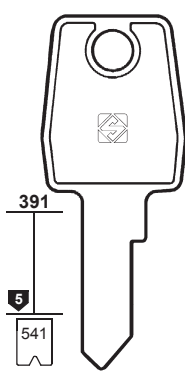

LF13
... 2001-4000

LF17
ATAL

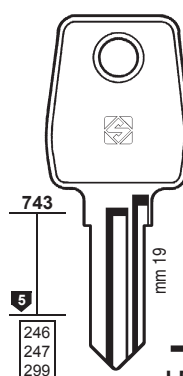

LF23R
EL ... 1-500
... 1001-1100
93 ... 401-900
... 9001-9500
EL ... 9001-9500

LF22R

LF22
93 ... 201-400
... 93901-94000

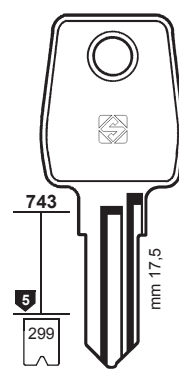

LF20
93901-94000

LF20R

LF16

LF26
77001-77500
95000-99000

LF16R

LF15R
... 90901-90975



LF57

DOUBLE SAFE - EURO LOCKS

DAD - MIBRA - UTZ

UTZ

LOWE & FLETCHER

PER:
FOR:

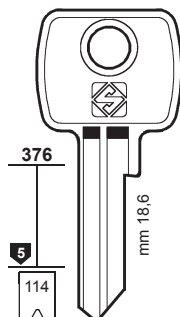

LF4
60 ... 1-400
90 ... 1-200
92 ... 1-400
... 1-400
GHM ... 1-155
M ... 1-400
92 ... 401-600
99 ... 1-400
RV ... 1-400
RVM ... 1-400
SP ... 1-400
GS ... 1-400
... ES1
... EV1

LF4R
99 ... 401-600
92 ... 501-700

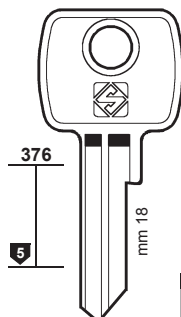

LF6
90 ... 1-200
... 1-400
91 ... 201-350
GH ... 1-400
SS ... 1-400
92 ... 401-600
GS ... 1-400

LF6R
90 ... 1-200
... 1-400
91 ... 201-350
GH ... 1-400
SS ... 1-400
92 ... 401-600
GS ... 1-400

LF18R

LF42R
FEE ... 1-100
NF ... 1-30

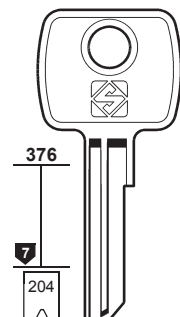

LF11
76 ...
1-400
...
70001-71200
GH ... 1-400
SS ... 1-400
92 ... 401-600
M ...
70001-71000

LF11R

LF52

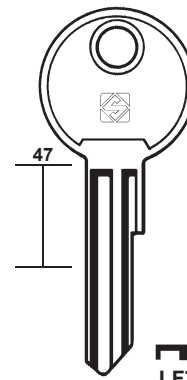

LF7

LF8

LF8R



TELFORD



PER:
FOR:

LOWE & FLETCHER

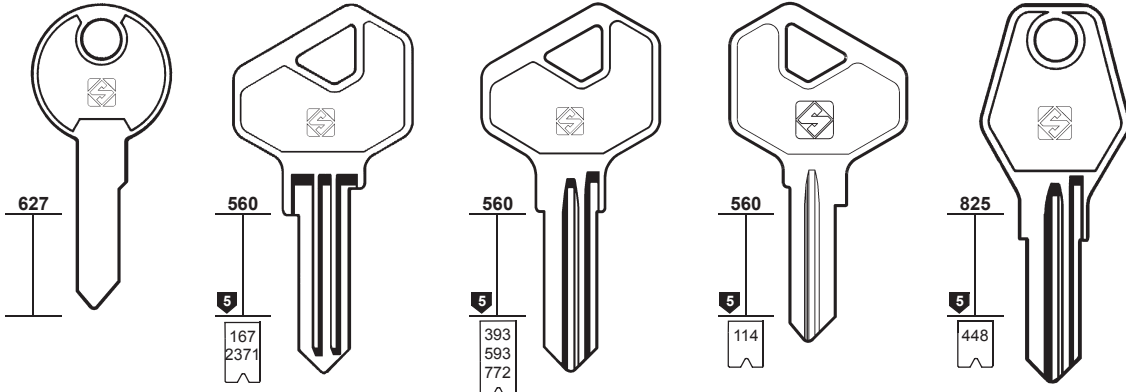

LF29R

LF24

LF25

LF27 **LF27R**

LF43R

LF37

V... 1-88
E... 101-600
RE... 101-600
... 5001-9000
... 31001-33000
... 36001-38000
... 87001-91000

419001-419420
19... 1-420
... 17001-19000
... 23001-23400
... 23001-25100
... 27001-27400
... 7001-7400
... 7001-9000
... 701-900
... 1-150

R... 151-650
T... 1-1000
S... 1-1000
... 9001-9494



AUSTRALIA



AUSTRALIA



129

PER / FOR

L & F (GB)
BASI
DAD
EURO LOCKS
LAUDON
ROLL-A-DOOR
+ CHICAGO (52)
+ EURO LOCKS (78-79)

PER:
FOR:

LOWE & FLETCHER

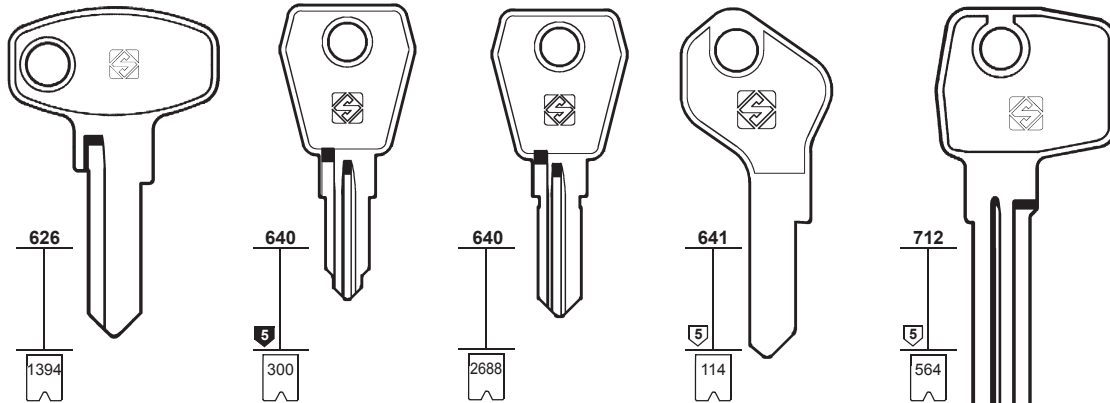

LF28R

LF30R

LF61R

LF31R

LF33 **LF51R**

RO2...
101-215

... 801-900
... 901-1000

... 6601-7100

60... 001-400
... 1-400
92... 1-400
M... 1-400
91... 201-350
... ES1
... RV1

68001-70000

EURO LOCKS
LAUDON



BASI - DAD



EURO LOCKS

PER:
FOR:

LOWE & FLETCHER

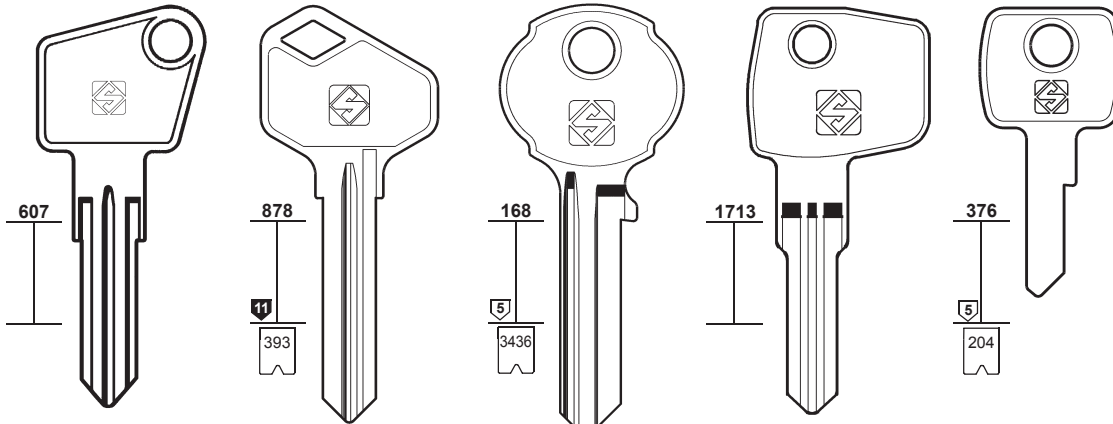

LF34

LF39

LF47

LF62

LF54

09... 1-900
29... 1-478

A... 12000-13049

75... 001-200



AUSTRALIA
ROLL-A-DOOR





130

PER / FOR

L & F (GB)

+ CHICAGO (52)

+ EURO LOCKS (78-79)

LOXEM (GB)

LR (IT)

+ MORI E. (142)

LUCO (TW)

+ GLOBE (97)

LUCKY (TW)

LUMA (ES)

TRELOCK

LUME (IT)

+ GIUSSANI (96)

LUNA (IT)

+ P.C. (CORTELLEZZI) (153)

LUX (EG)

LYF (ES)

M (IT)

+ CAS-CISMA (45)

MAFOR (FR)

+ RONIS (161)

PER:
FOR:

LOWE & FLETCHER

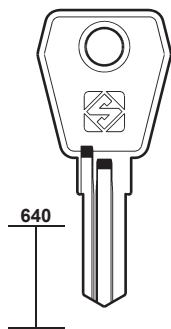

LF46R

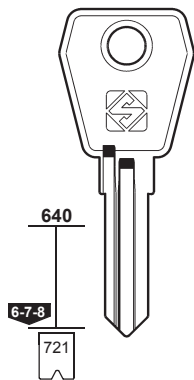

LF45R

ME ... 001-300
..... 18000-18999
..... 19000-19999
..... 35000-35499
..... 78000-78999
..... 79000-79999

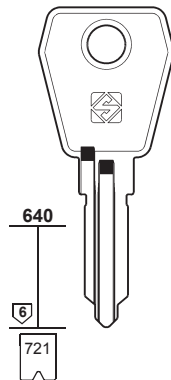

LF53

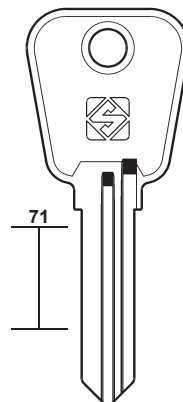

LF58R

LF59R

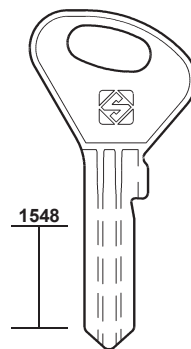

LF56

LF44



PER:
FOR:

LOXEM

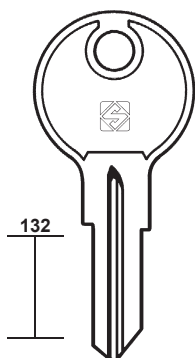

LXM1R

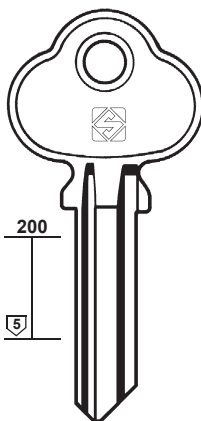

LU1

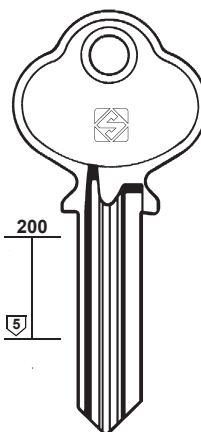

LU2

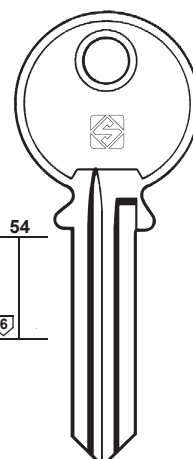

LU3R

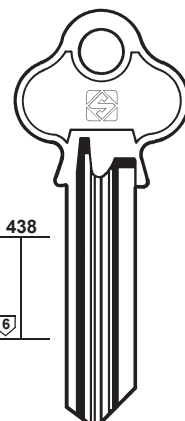

LU4

PER:
FOR:

LUMA

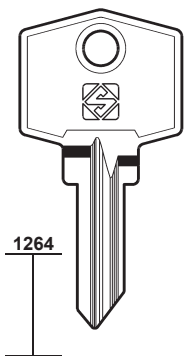

LM3

LM4

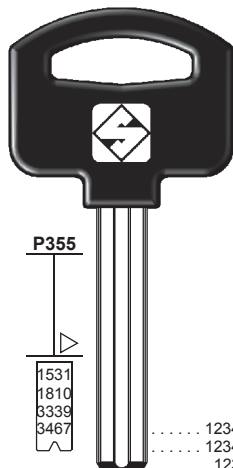

LM3R

LM4R

LM5P

..... 1234
..... 1234
..... 1234
..... 01234



LUX

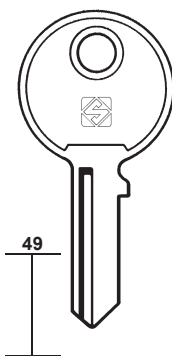

LX1

LX1R



LYF

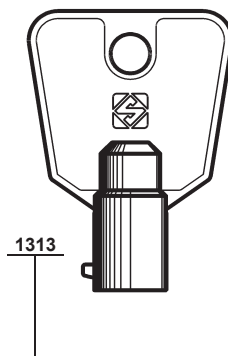

LYF1T

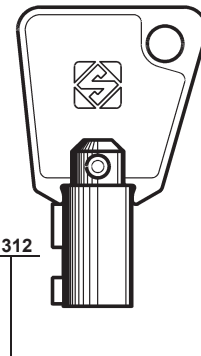
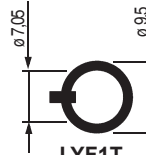

LYF2T

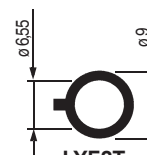

..... 654321
..... 76543210

PER:
FOR:

MAGNUM

MARIANI

MARS

MASTER

S1246
S1261
S1262
S1263
S1378
S1379
S1380
S1381
S1382
S1383

MGN1R MGN1RP

MR1

MAR1

MS8



131

PER / FOR

MAGNUM (GB)

MAQUET (FR)
DOM (70)

MARCADET (FR)
LAS (121-122)

MARCO (DE)
DOM (70)

MARIANI (IT)

MARK (TW)
TRI-CIRCLE (190)

MARLIN (IT)
BOSS (37)

MARS (TW)

MASTER (US)
HAMPTON
+ ABUS (8)
+ KWIKSET (119)
+ TOK-WINKHAUS (184)

PER:
FOR:

MASTER

MS19 MS17 MS24

..... 01234567
410K ... 001-999

MS5R MS6

10T ... 1-1000

MS13R MS9R MS4R MS3 MS11

..... 1-9800
34H ... 601-912

10L ... 1-1000

MS10

PER:
FOR:

MASTER

MS16 MS7 MS1 MS12 MS2 MS14

P ... 1-850
T ... 1-3000
X ... 1-1500

..... 3201-4000
A ... 101-2100
A ... 5501-6400
U ... 1-3250
X ... 2001-3000
X ... 5001-6000
M ... 2001-4515
J.U. ... 01-50

MS2 1K

..... 1-3200
A ... 101-2100
A ... 5501-6400
E ... 1-700
E ... 2001-3000
J ... 301-1250
J ... 2001-2150
USN ... 1-4500
W ... 0-3500
WO ... 1-1000
X ... 2001-3000
X ... 5001-6000
..... 4201-5000
..... 5001-6000
..... 6001-7000
..... 7001-8000
..... 8001-9000
..... 9001-10000
M ... 2001-4515

MS23

MS22



132

PER / FOR

MASTER (US)

- + ABUS (8)
- + KWIKSET (119)
- + TOK-WINKHAUS (184)

MASTER LOCK (TW)

- + CINA (54)

MATTEY (FR)

- + SUREX (178)

MAUER LOCKS (BG)

- + DEKABA
- + DEKABA (65)

MAUSER (DE)

- + CES (47)
- + HOPPE (103)
- + HUWIL (104)

MAXIGARD (FR)

- + GABON (93)

PER: MASTER
FOR:

P350
S902

P262

MS20P MS21AP

PER: MASTER LOCK
FOR:

1577

1295

1295

MSL1 MSL2 MSL3

PER: MASTER LOCK
FOR:

1716

1716

MSL4R MSL5R

PER: MAUER
FOR:

1650

1362

MAU1R MAU2

DEKABA

PER: MAUER
FOR:

1362

1362

1305

MAU3 MAU4 MAU5R

DEKABA

PER:
FOR:

MAXUS

MAY-TAY

MCM

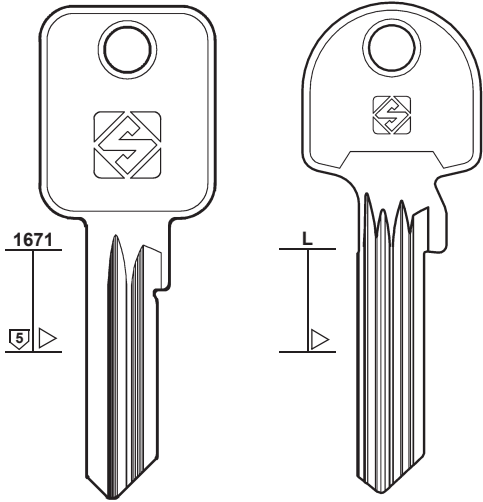

MXU1R

MXU2

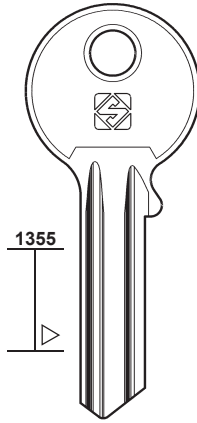

MAY1

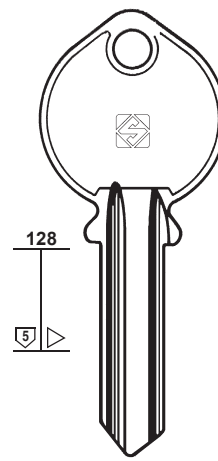

MC1

MC1R



133

PER / FOR

MAXUS (GB)

MAY-TAY (IL)

MBB (DE)
CES (47)

MCM (ES)
MONDRAGON

PER:
FOR:

MCM

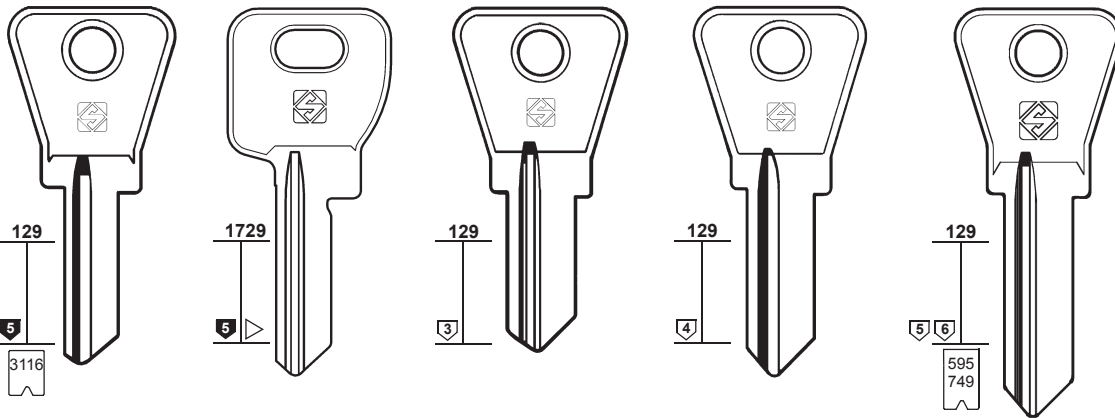

MC4 **MC4R**

OV
33436-77674

MC23

MC6 **MC6R**

MC5 **MC5R**

MONDRAGON

MC2 **MC2R**

1..... 2.....
1-2-3-4-5-6-7 1-2-3-4-5-6-7
.....
0-1-2-3-4-5-6-7

PER:
FOR:

MCM

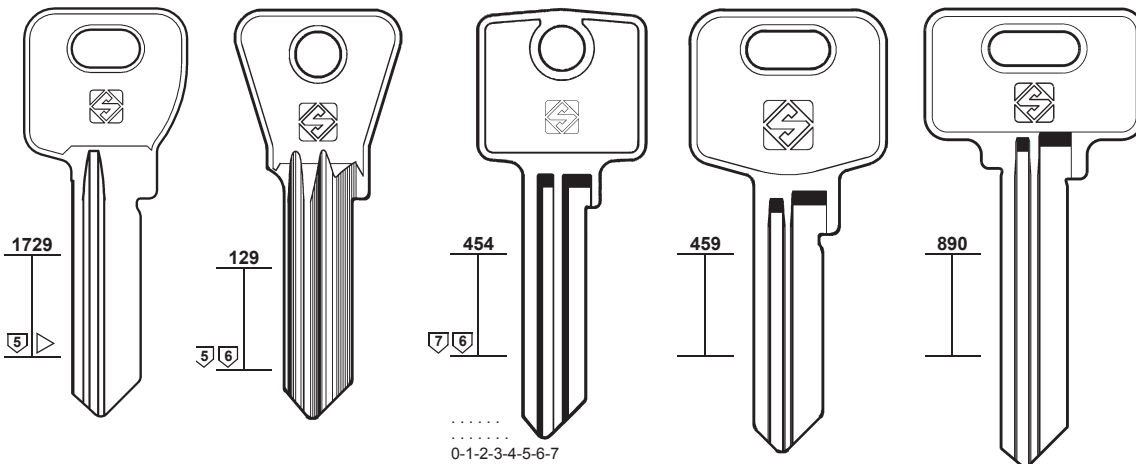

MC22

MC7

MC3

MC17

MC8

MC22R



MONDRAGON



134

PER / FOR

MCM (ES)
GERDA
LOB
TROMER
YETI

MECALUX (FR)
AGA (11)

PER:
FOR:

MCM

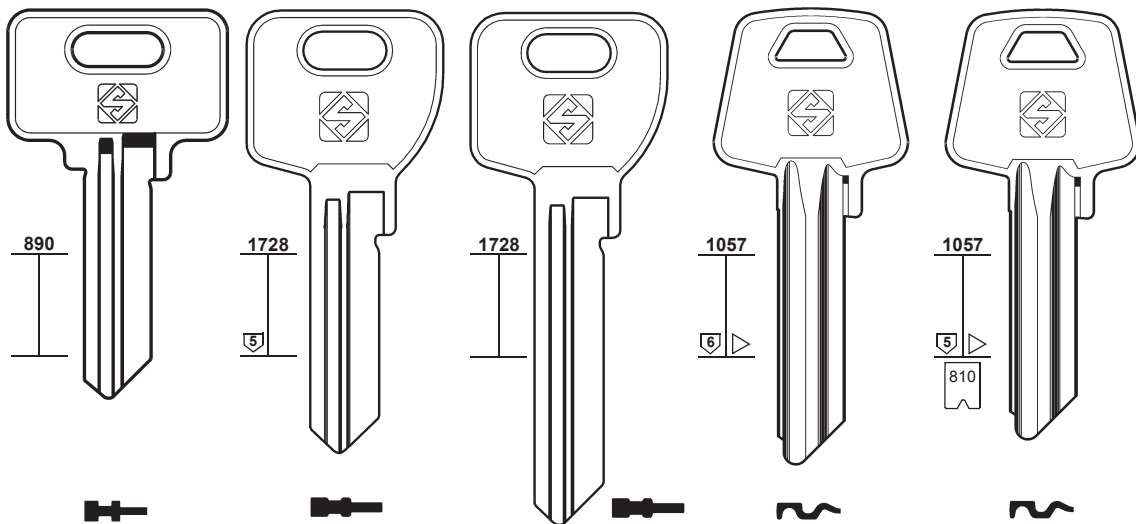

890

1728

1728

1057

1057

MC13

MC24

MC25

MC11
X

MC12

E 11241-79868
X 123456789

PER:
FOR:

MCM

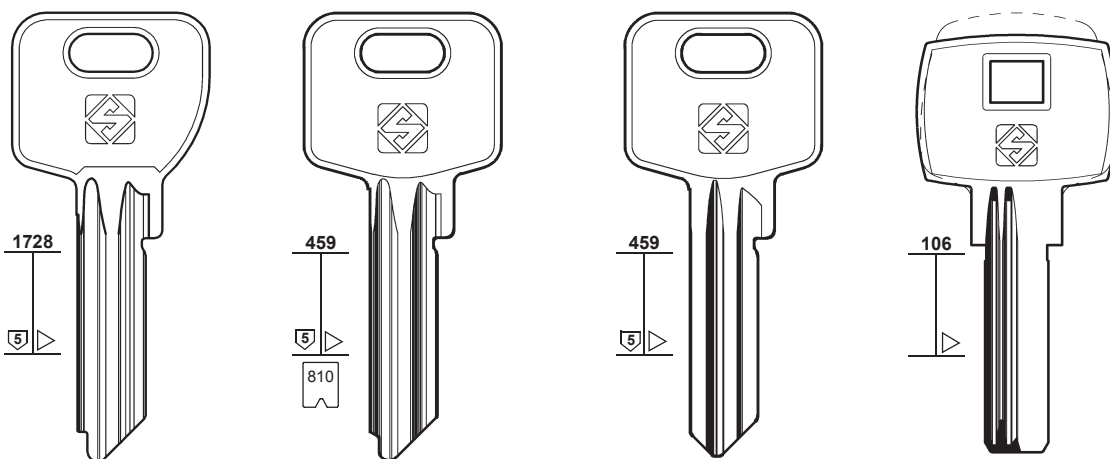

1728

459

459

106

MC21

MC20

X 1234567890
E 11241-79868

MC18R
B

MC14R

MC19R
C



PER:
FOR:

MCM

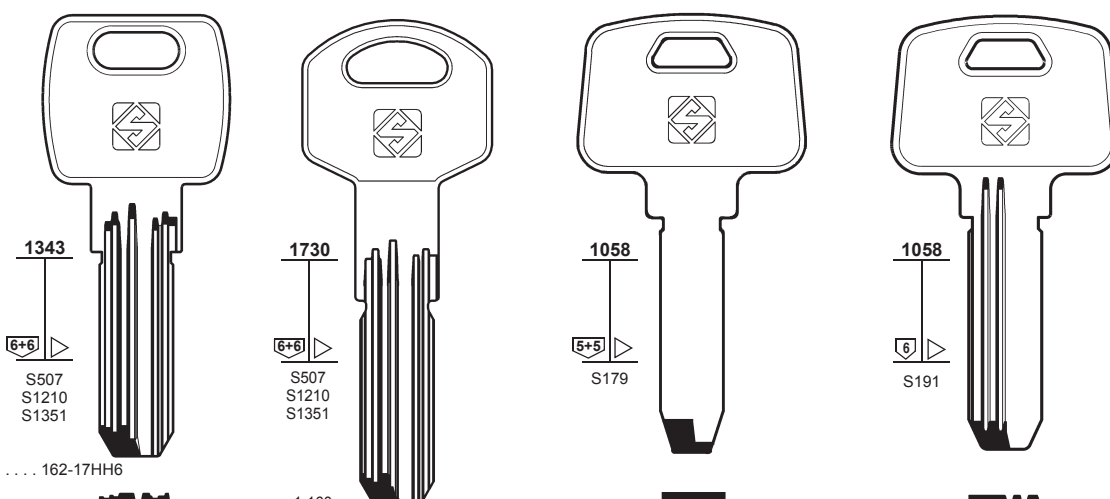

1343

1730

1058

1058

S507
S1210
S1351

. 162-17HH6

MC15R
E8

S507
S1210
S1351

. 1-160
. 012345678

MC26R

S179

MC9X
4SS

S191

MC10R
4SE



LOB - YETI



TROMER

PER: **MECO**
FOR:

MEDECO

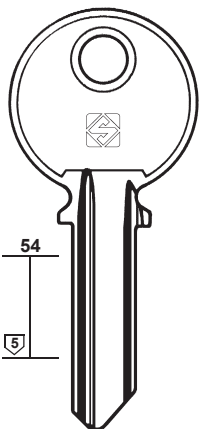

5



MEC1

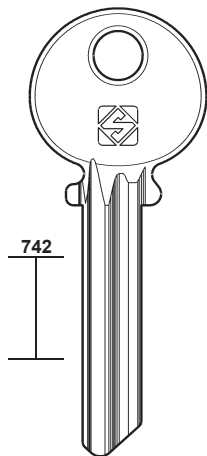

742



MD4

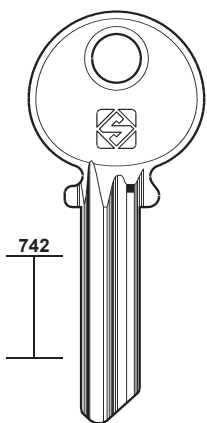

742



MD7

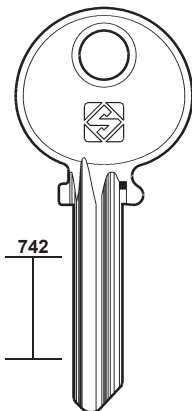

742



MD6

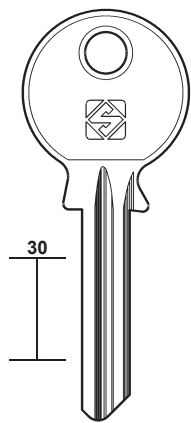

30



MD1R



MD11



MD8R



135

PER / FOR

MECO (DE)

MEDECO (US)

ME-FA (TW)
BRABANTIA
CLAUSOR

MEGA (RO)

MELSMETALL (DE)
BURG
HBC

PER:
FOR:

ME-FA

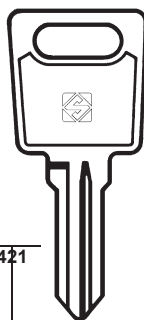

421

5

492



MF1R

... 1-100
... 101-200

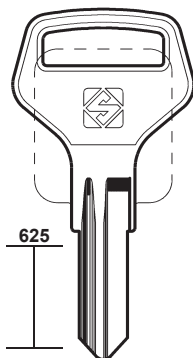

625



MFA1



BRABANTIA - CLAUSOR

MEGA

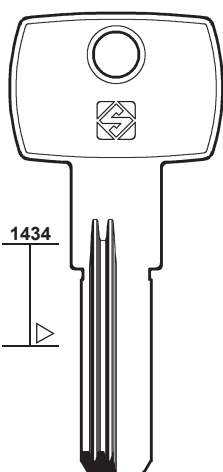

1434



MEG1R

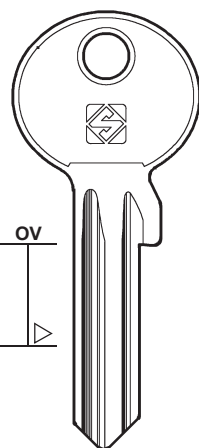

OV



MEG2



PER:
FOR:

MELSMETALL

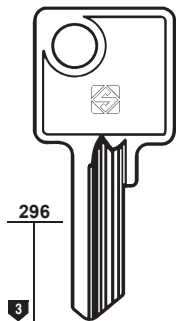

296

3



ME2R

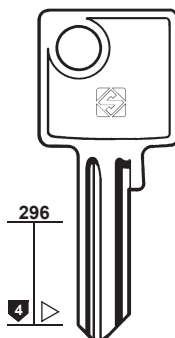

296

4



ME8

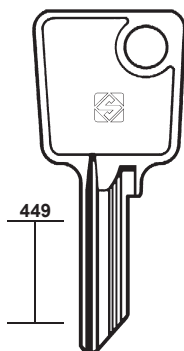

449



ME1

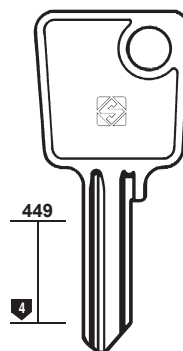

449

4



ME3



ME6

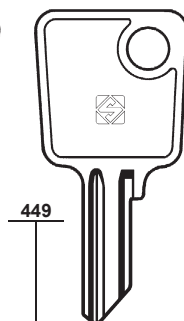

449



ME7



ME4



ME4R

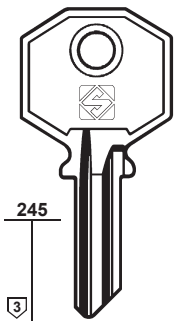

245

3



BUR6



HBC



BURG



136

PER / FOR

MELSMETALL (DE)

BURG
 FARCE
 KEYA
 SES
 + BURG (42)

MENOVA (DE)

DOM (68)

MERCUR (DE)

JOWIL (110)

MERLE (AR)

MERMIER (FR)

CORBIN (59-60)

MERONI (IT)

BIB
 CAROLI
 LAMA
 NOVOTECNICA
 + CAS-CISMA (45)
 + EVERGOOD (80)

PER:
FOR:

MELSMETALL

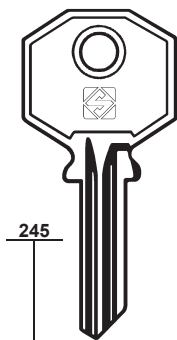

245



BUR2



BURG

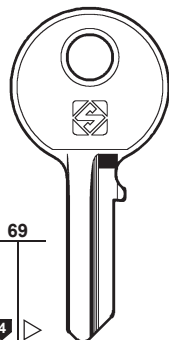

69

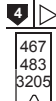

ME9

6 ... 1-30
 6 ... 31-60
 1234



FARCE
KEYA - SES

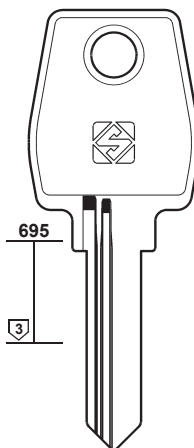

695



ME10R

MERLE

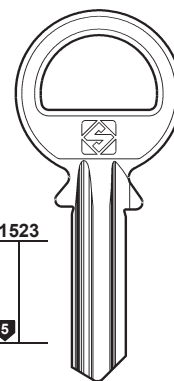

1523



MLE1

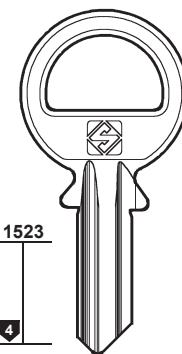

1523



MLE2

PER:
FOR:

MERONI

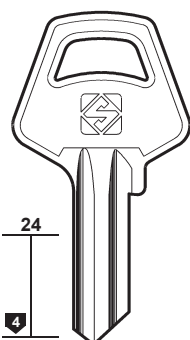

24



MER1

... 1001-1500

BIB - NOVOTECNICA



MER1R



LAMA

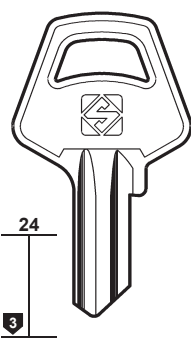

24



MER27

... T001-113

... 1701-1810

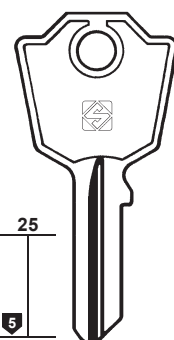

25

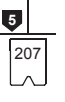

MER4

G ... 3001-3480

G ... 0-479

... 3001-3480



MER4R



LAMA

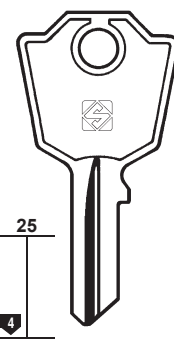

25



MER5

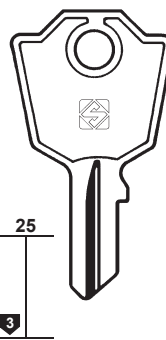

25



MER6



MER6R



PER:
FOR:

MERONI

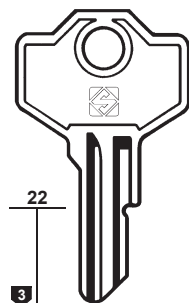

22



MER7R

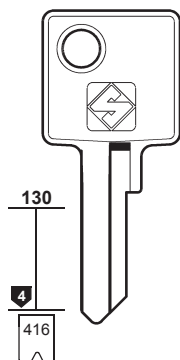

130



MER2

... 1-294
 ... 301-400
 ... 401-694
 ... 941-975



CAROLI

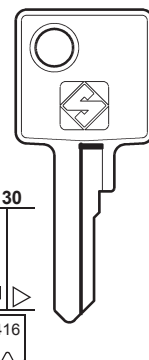

130



MER24

... 1-294

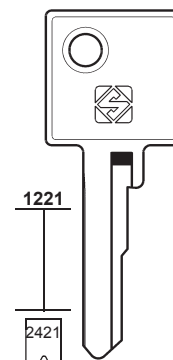

1221



MER29

... 1-294
 ... 301-400
 ... 401-694
 ... 941-975



PER:
FOR:

MERONI

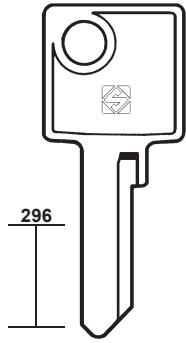

MER23
PREMI-APRI

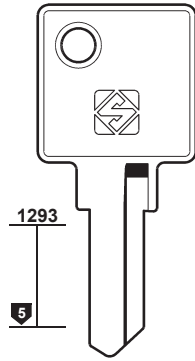

MER31

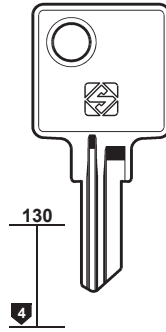

MER32



137

PER / FOR

MERONI (IT)
EBA
IJ
JTF
MING-TAY
WINFOR
+ CAS-CISMA (45)
+ EVERGOOD (80)

PER:
FOR:

MERONI

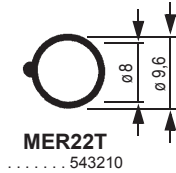
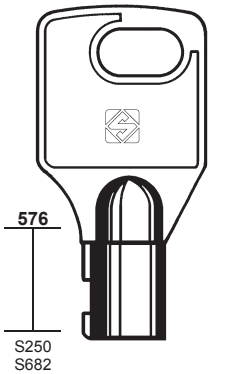

MER22T
..... 543210

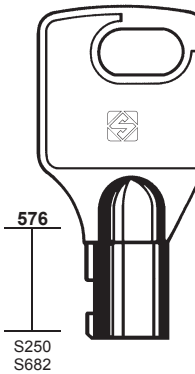

MER25T
..... 543210

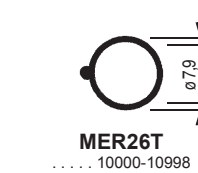
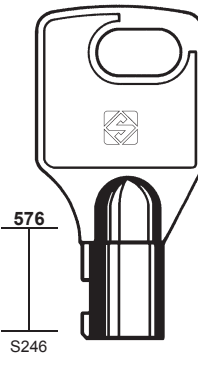

MER26T
..... 10000-10998

MING-TAY - WINFOR

PER:
FOR:

MERONI

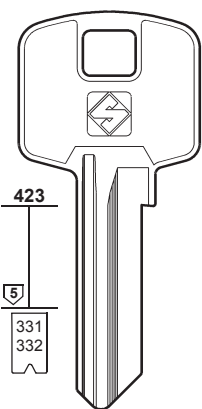

MER8
..... T
0-1-2-3-4-5-6-7-8-9
M
0-1-2-3-4-5-6-7-8-9

PREMI-APRI
EBA - IJ - JTF

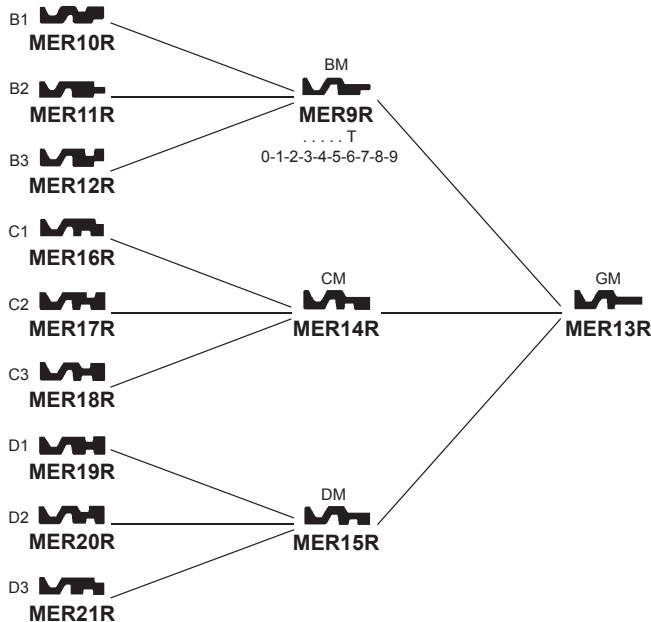



138

PER / FOR

MERONI (IT)

- + CAS-CISMA (45)
- + EVERGOOD (80)

METAL (BG)

- + OJMAR (147)

METALCASTELLI (IT)

- + GIUSSANI (96)
- + HEKNA (102)
- + PREFER (157)

METALUX (FR)

- + TESA (181)
- + VACHETTE (199)

PER:
FOR:

MERONI

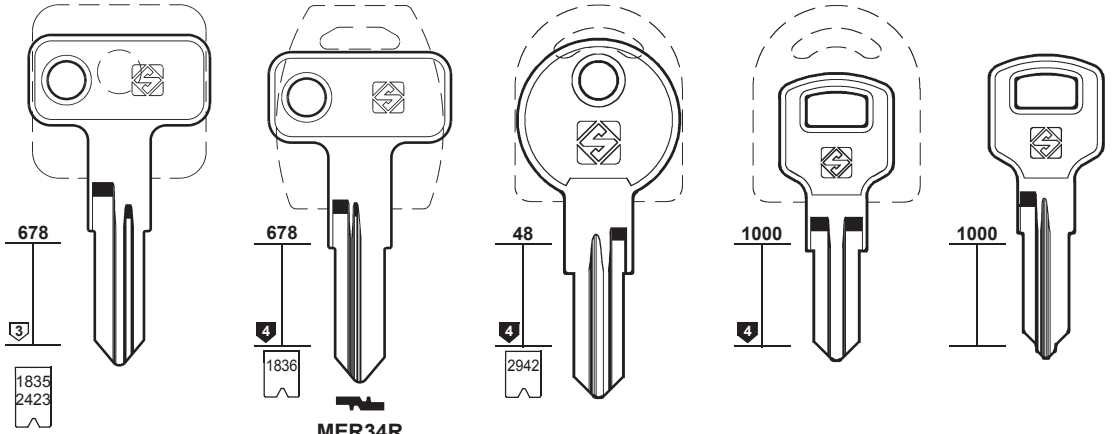

MER33R

... 0-1-2-3
... 1-709
CB ... 1-709

MER34R

CC ... 4001-4650

MER35R

CD

MER36

..... 1234

MER37

MER42R



PER:
FOR:

MERONI

METAL

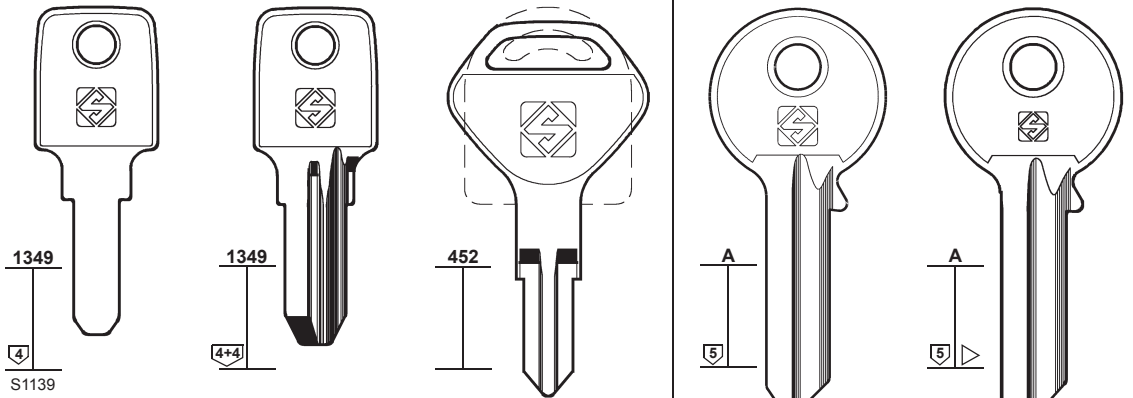

MER39

WA

MER38

MER41

MTA1R

MTA3R



PER:
FOR:

METAL

METALUX

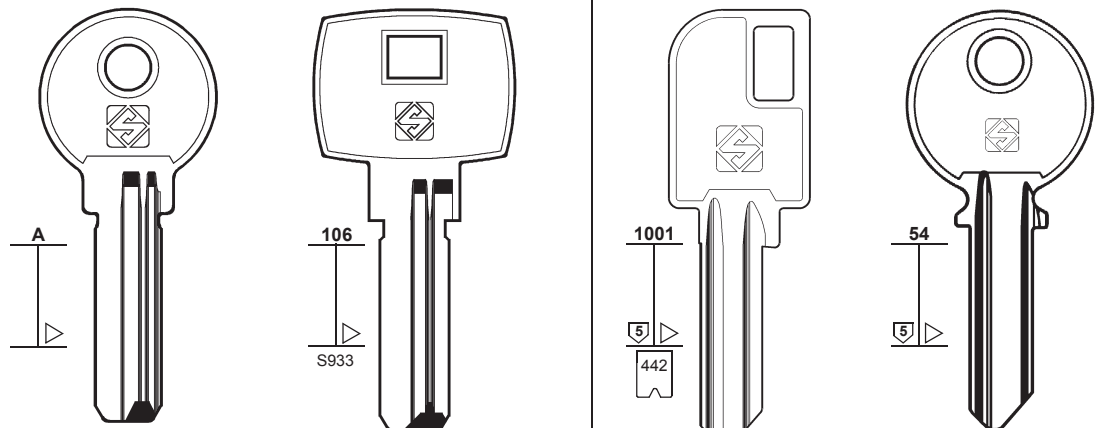

MTA4

MTA2

MX1

MX5



... 1001-2178
L ... 1001-2178
... 1234567
L ... 14001-14500
L ... 15001-18199
... 20001-20625

PER: METEOR
FOR:

MG (MONTI)



139

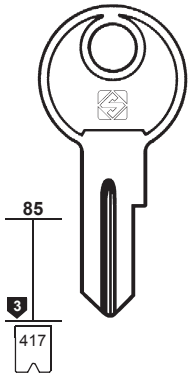

MET1
B ... 1-600
G ... 1-600

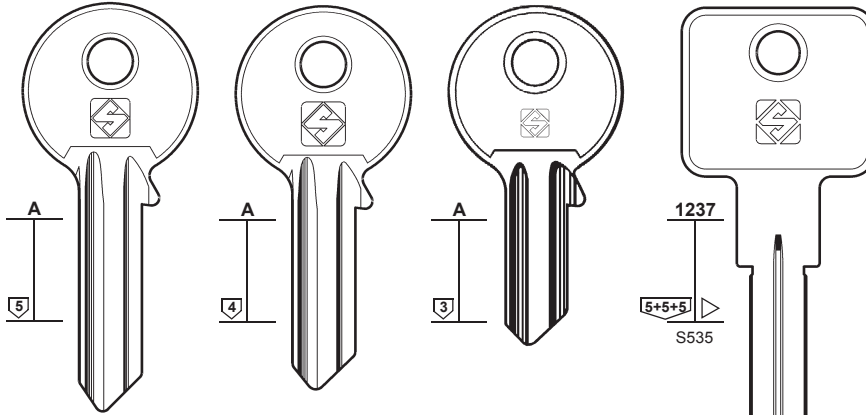

MG1 **MG1R** **MG2** **MG2R** **MG3** **MG3R**

001001-163000

MG8
PBA



PER / FOR

METEOR (FR)
+ BKS (35)
+ DOM (68)
+ KIFERM (117)

METIZ (UA)
+ KIEV (117)

MG (MONTI) (IT)

MIAN-FORCE (TW)
+ GLOBE (97)

MIBRA (GB)
+ L & F (128)

MICHEL-SEAT (IT)
O.M.R.
POTENT
+ O.M.R. (149)
+ POTENT (156)
+ SEAT (167)

MILA (DK)
+ EVO (80)

MILANO (BR)

PER: MG (MONTI)
FOR:

MICHEL-SEAT

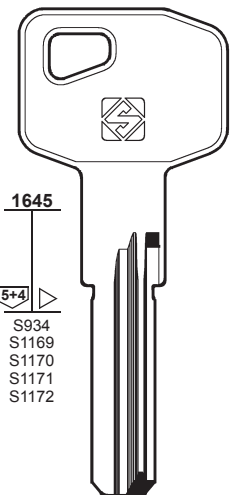

S934
S1169
S1170
S1171
S1172

A5 ... 00010-28000
A6 ... 00010-28000
A7 ... 00010-28000
A8 ... 00010-28000

MG9
X8

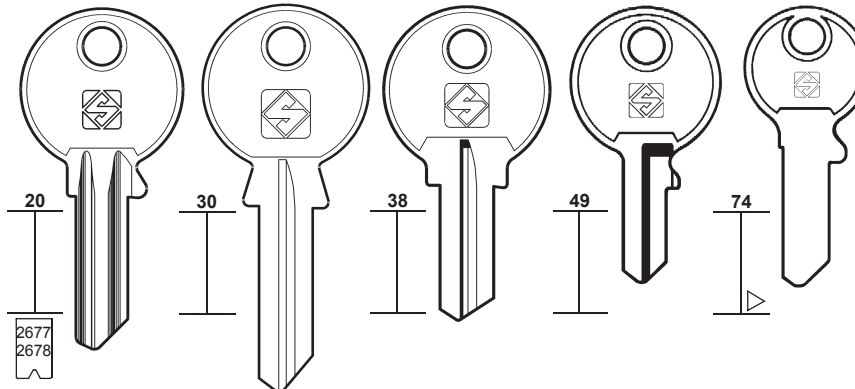

MH1
... 201-436

MH1R
... 437-672

MH2

MH2R

MH4

MH4R

SEA4

SEA4R

MH3

POTENT



POTENT
O.M.R.



PER: MICHEL-SEAT
FOR:

MILA

MILANO

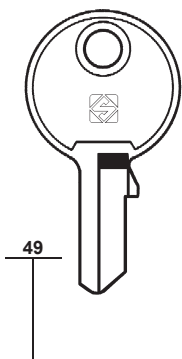

MH5

MH5R

POTENT

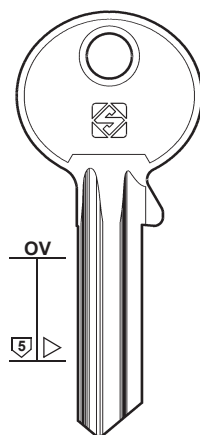

MIL1

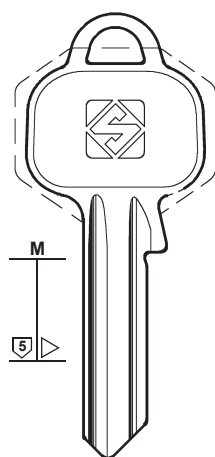

MIL2

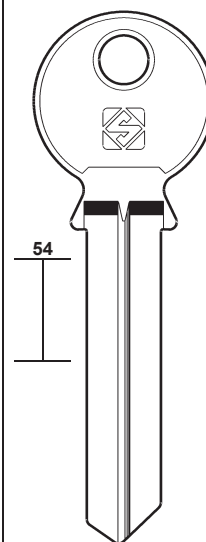

MLN3

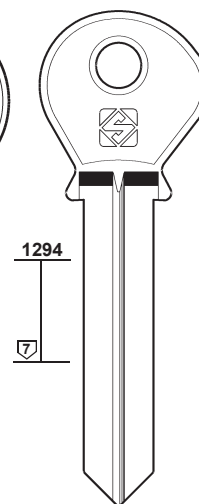

MLN1



140

PER / FOR

MILES (RU)

MING-TAY (TW)

SOS
+ MERONI (137)

MIPPART (DE)

DOM (70)

MIT (IT)

INDESIT (107)

MIWA (JP)

NITI LOCKS

PER:
FOR:

MILES

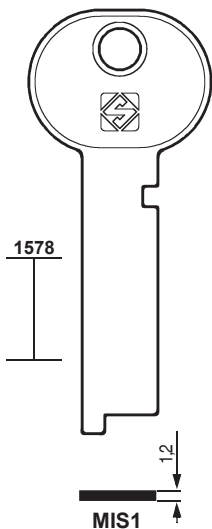

MIS1

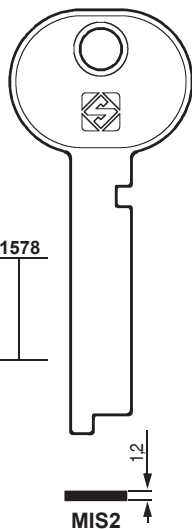

MIS2



MING-TAY

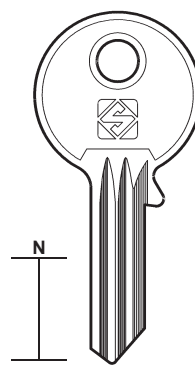

MTY1

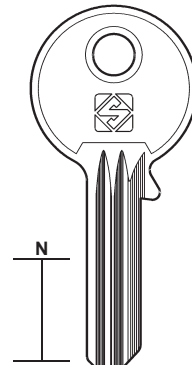

MTY2

SOS

PER:
FOR:

MIWA

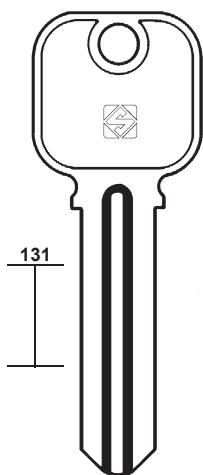

MIW1

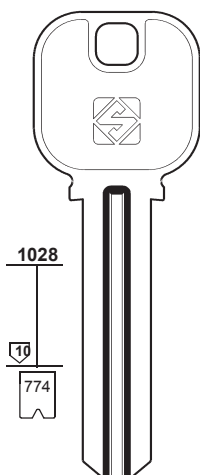

MIW2

.....
1-2-3-4

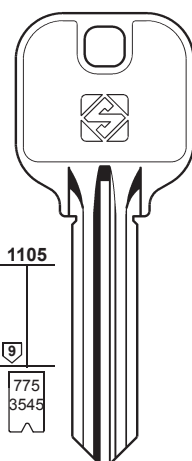

MIW3

.....
0-1-2-3-4

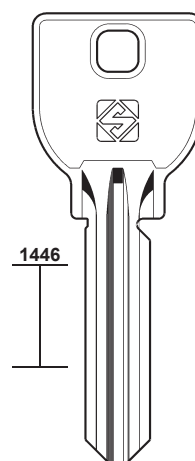

MIW14

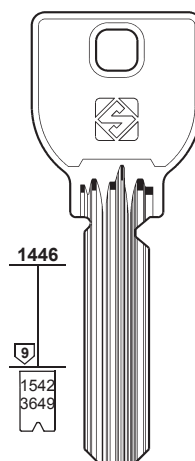

MIW15

.....
0-1-2-3-4-5

NITI LOCKS

PER:
FOR:

MIWA

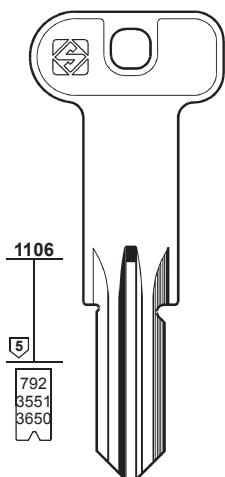

MIW13

..... 1234
..... 01234

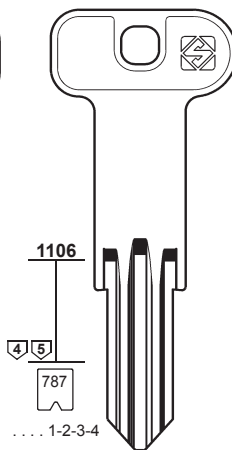

MIW4

..... 1-2-3-4

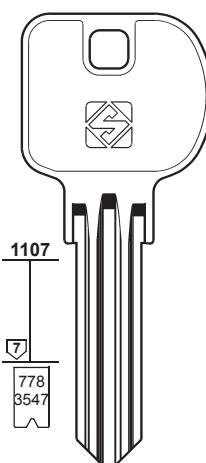

MIW5

.....
1-2-3-4-5

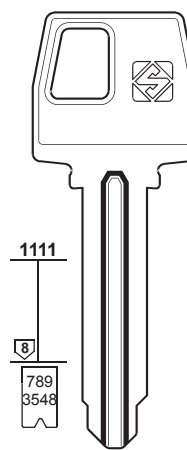

MIW6

.....
0-1-2-3-4

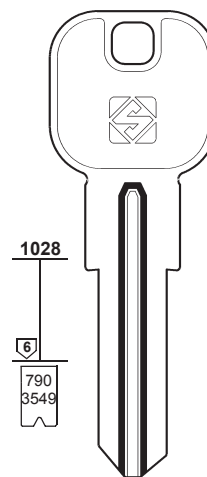

MIW7

.....
1-2-3-4

PER:
FOR:

MLM

MLP

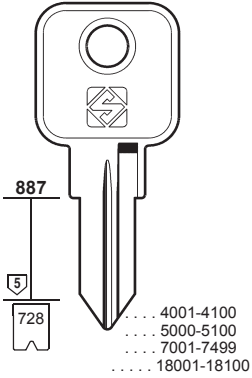

MLM1

MLM1R

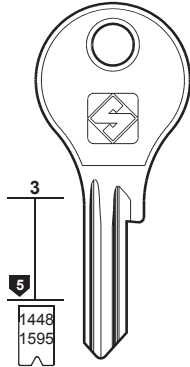

MLM2 L... 1-101
L... 1-222

MLM3R **MLM6R**
MLM4R **MLM7R**

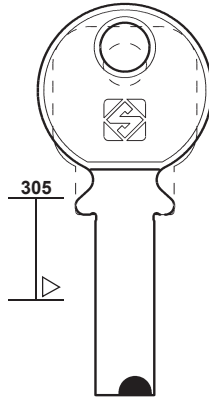

MLM5

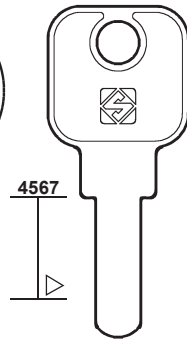

MLM15

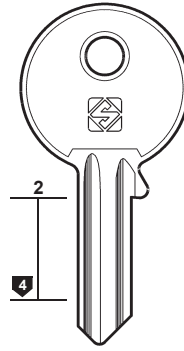

GS2 **GS2R**

GIUSSANI

DOM - LEHMANN - ORDO - STUV



141

PER / FOR

- MLM (DE)**
- DOM
- LEHMANN
- ORDO
- STUV
- + DOM (68-70)
- + LEHMANN (122)
- + OJMAR (147)
- + RONIS (161)

- MLP (IT)**
- GIUSSANI
- + GIUSSANI (96)

MOBELLA (SE)

- MODA (FR)**
- PICARDIE (155)

MODERN (TW)

- MODERN BAU (DE)**
- VACHETTE (199)

- MOFLEX (ES)**
- OJMAR (147)

MOIA (IT)

MON (ES)

- MONACOR (TW)**
- ALPHA (16)

- MONDIAL (FR)**
- G.R. (99)
- RONIS (161)

- MONDRAGON (ES)**
- MCM (133)

- MONOBLOC (FR)**
- FO
- + ZENITH (222)

MONTI-MG (IT)

PER: MOBELLA

MODERN

MOIA

MON

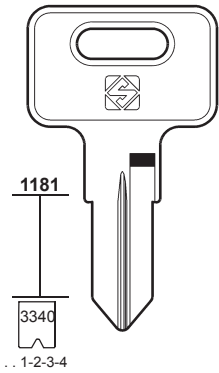

MBL1

MBL1R

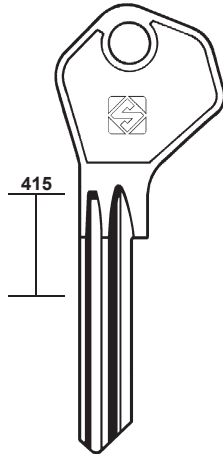

MOD1

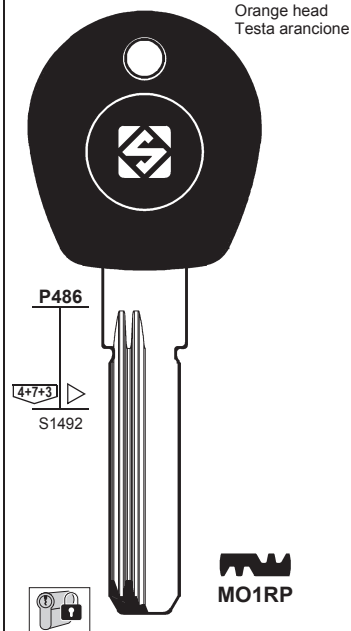

MO1RP

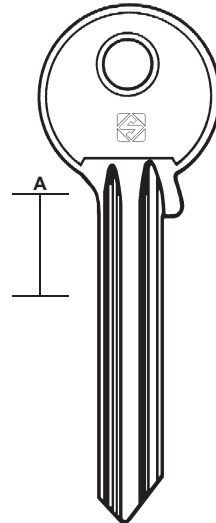

MON1 **MON1R**

PER: MONOBLOC

MONTI-MG

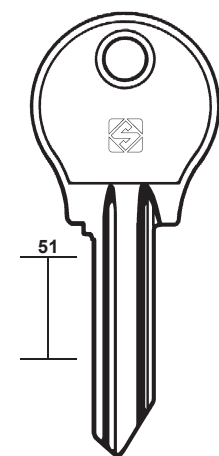

MB1
FO

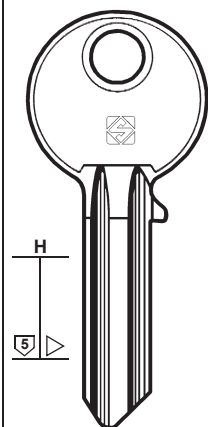

MN9 **MN9R**

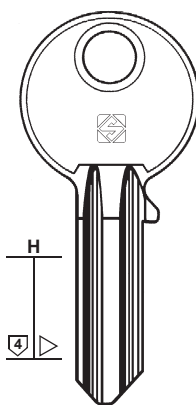

MN8 **MN8R**

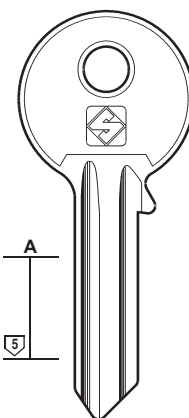

MN2 **MN2R**

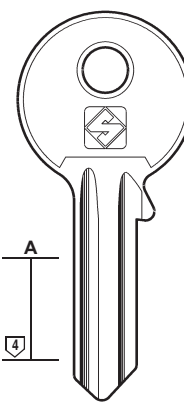

MN1 **MN7** **MN7R**

MN3 **MN3R**



142

PER / FOR

MONTI-MG (IT)

MOREAUX (FR)

👁️ DOM (71)

👁️ RONIS (161)

👁️ WALLY (207)

MORI E. (IT)

CRISTIANI

FEB

LML

LR

TAMPALINI

ZANI

+ 👁️ FIAM (88)

MORI G. (IT)

MOSCON (RU)

MOSRENTGEN (RU)

MOTORSICH (UA)

PER:
FOR:

MONTI-MG

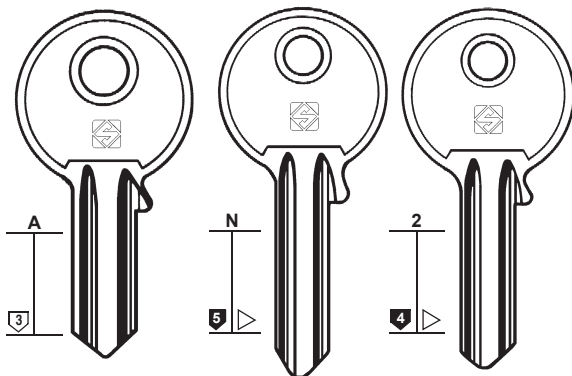

MN4



MN5



MN6



MN4R



MN5R



MN6R

MORI E.

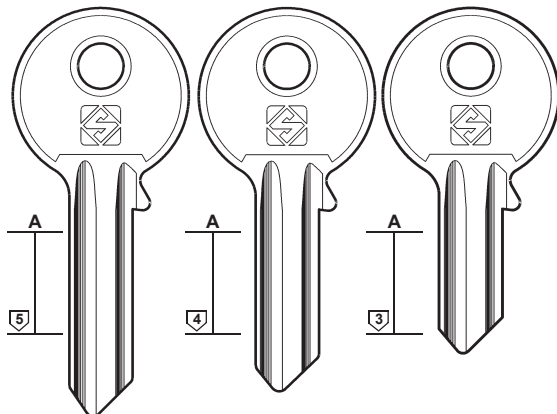

MI1



MI2



MI5



MI1R



MI2R



MI5R

CRISTIANI - LML - LR - TAMPALINI - ZANI

PER:
FOR:

MORI E.

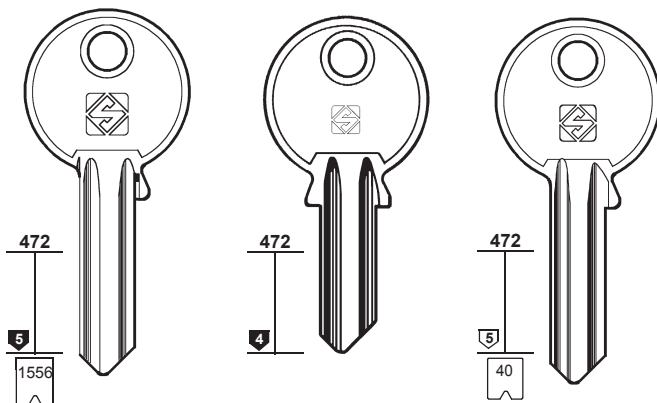

MI3



MI7



MI8



MI3R



MI7R

FEB

..... 1-2-3-4-5-6

G... 1-78

MORI G.

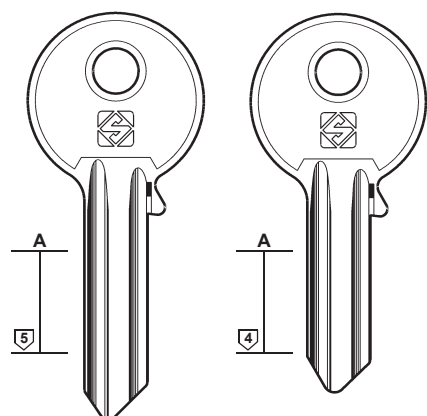

MIG1



MIG2



MIG1R



MIG2R

PER:
FOR:

MOSCON

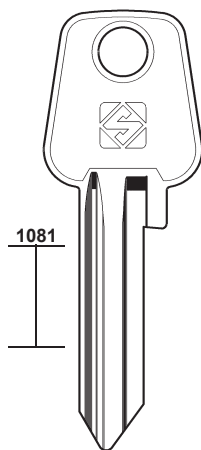

MSC1

MOSRENTGEN

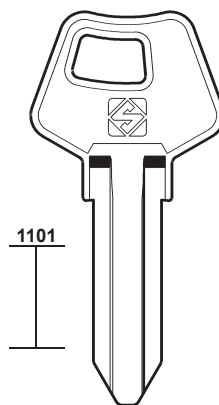

MST1

MOTORSICH

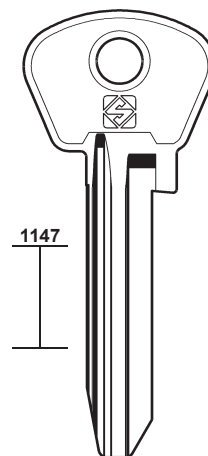

MTS1



MTS1R

PER:
FOR:

MOTTA

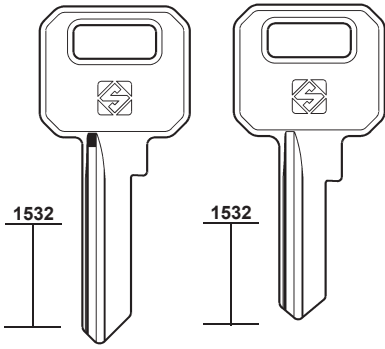

MTT1R

MTT2R

MP-PLODARI

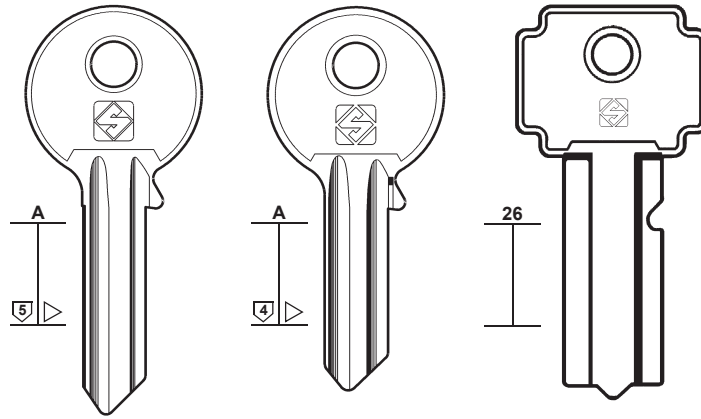

MP230

MP231

MP228

MP229

MP101



143

PER / FOR

MOTTA (BR)

MOTTURA (IT)
GEVY (95)

MP-PLODARI (IT)

MSM (CN)
CINA (54)

M.S.S. (PT)

MST (IT)
CAS-CISMA (45)

MSV (PT)

MUKRA (DE)
CORBIN (60)

MULT-LEI (GR)

MULT (BR)

MUL.T.LOCK (IL)
CORNI (62)

PER:
FOR:

MP-PLODARI

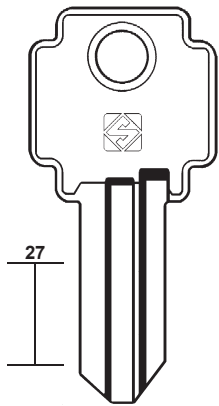

MP102

MP103

MP104

MP105

M.S.S.

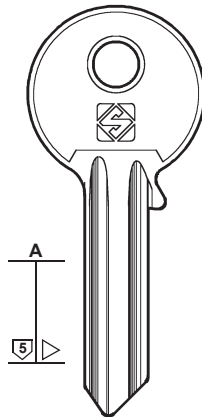

MSF1

MSV

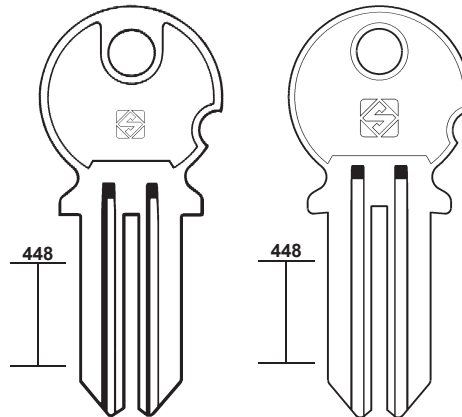

MSV1

MSV2

MSV1R

MSV2R

PER:
FOR:

MULT-LEI

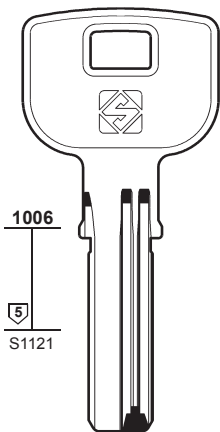

S1121

MTL1



MULT

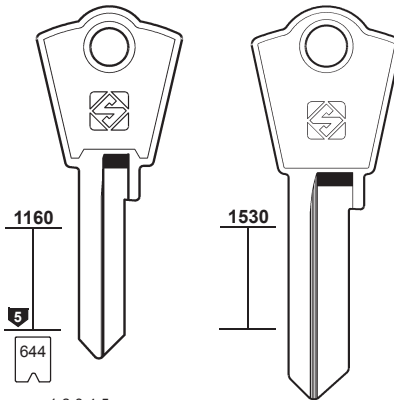

644

..... 1-2-3-4-5

MUL1

MUL2

MUL.T.LOCK

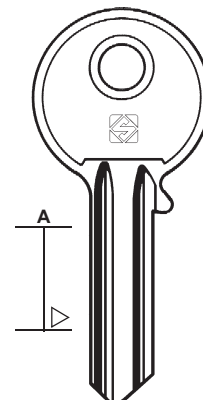

MTK5

MTK5R



144

PER / FOR

MUL.T.LOCK (IL)
GARRISON
SP

+ CORNI (62)

PER:
FOR:

MUL.T.LOCK

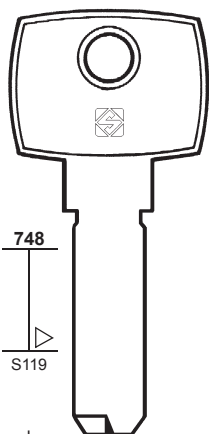

748
S119

J...
9001-9766

MTK1

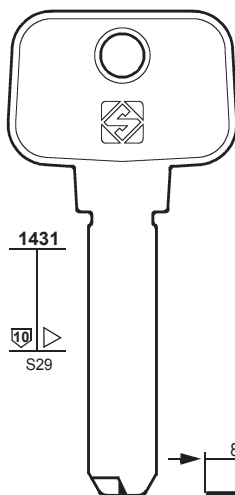

1431
S29

8.8

MTK2
(006)
ABCD-12345

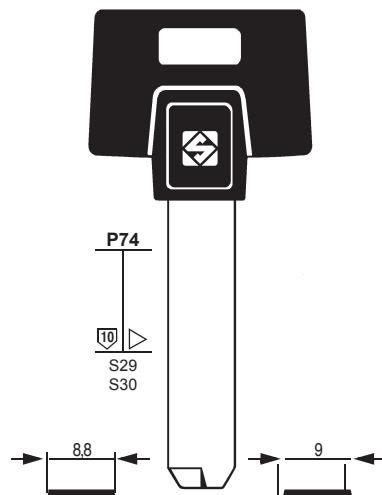

P74
S29
S30

8.8

MTK2P
(006)
ABCD-12345

9

MTK3P
(006)
ABCD-12345-01



PER:
FOR:

MUL.T.LOCK

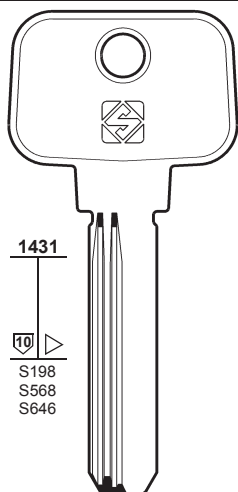

1431
S198
S568
S646

MTK11R



GARRISON

05
MTK11
(005)
ABCD-12345

11
MTK16

MTK10R
(006)
ABCD-12345-01

66
MTK15R

64
MTK8R
(006)
ABCD-12345-01

77
MTK13R

50
MTK7R
(006)
ABCD-12345-01

08
MTK12R
(008)
ABCD-12345

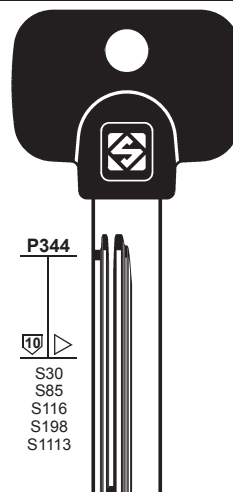

P344
S30
S85
S116
S198
S1113

MTK10RP
(006)
ABCD-12345-01



SP

MTK9RP

64
MTK8RP
(006)
ABCD-12345-01

50
MTK7RP
(006)
ABCD-12345-01

05
MTK4P
(005)
ABCD-12345

06
MTK4RP
(006)
ABCD-12345-01

PER:
FOR:

MUL.T.LOCK

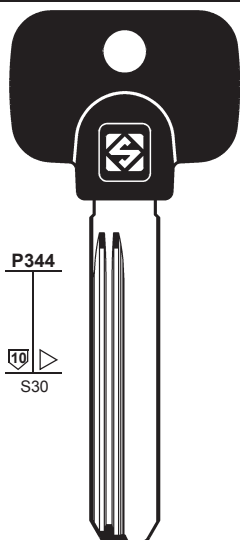

P344
S30

MTK4RPX

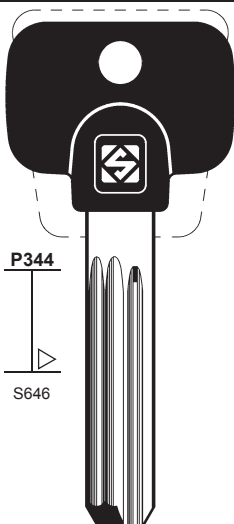

P344
S646

MTK12RP
(008)
ABCD-12345

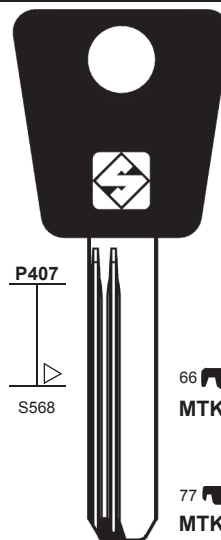

P407
S568

66
MTK15RAP

77
MTK13RAP

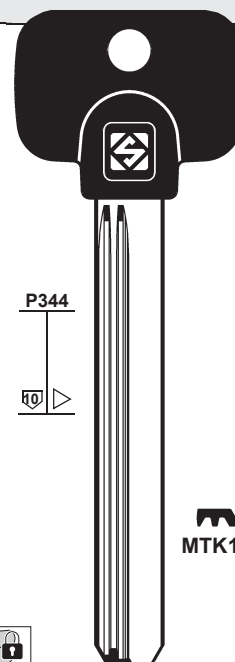

P344

MTK14RP



GARRISON

PER:
FOR:

NABOB

NAIKI

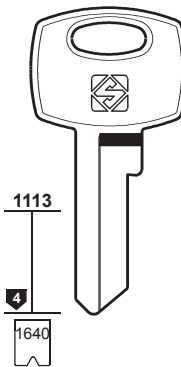
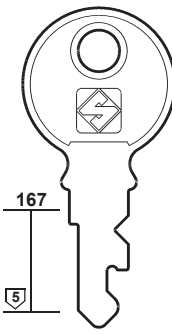
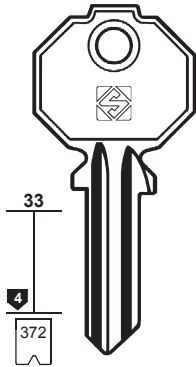
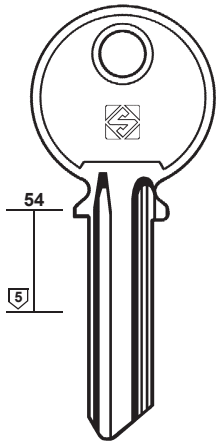
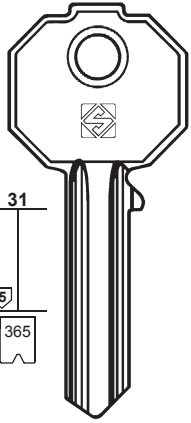

0-1-2-3-4-5-6-7-8

0-1-2-3-4-5-6



145

PER / FOR

NABOB (IL)

NAIKI (JP)

NATIONAL CABINET (US)
NATIONAL CASH REGISTER
NATIONAL ROCKFORD

NATIONAL CASH REGISTER (US)
NATIONAL CABINET (145)

NATIONAL LOCK HARDWARE (US)
NATIONAL ROCKFORD (145)

NATIONAL ROCKFORD (US)
NATIONAL LOCK HARDWARE
+ NATIONAL CABINET (145)

NAZABAL (ES)
EZCURRA (82)

NB (DE)
CISA (55)
FLORA (90)

NEC (JP)

NELFA (DK)

PER:
FOR:

NATIONAL CABINET

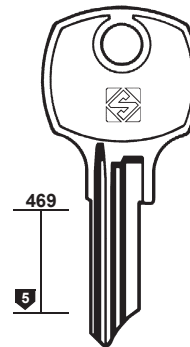
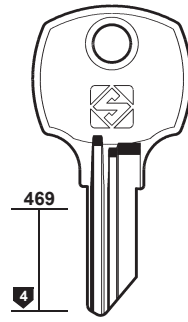
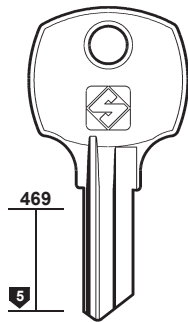
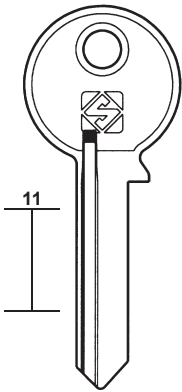

NATIONAL CASH REGISTER

NATIONAL ROCKFORD



PER:
FOR:

NATIONAL ROCKFORD

NEC

NELFA

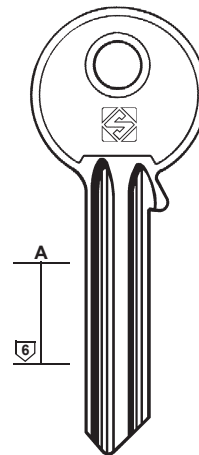
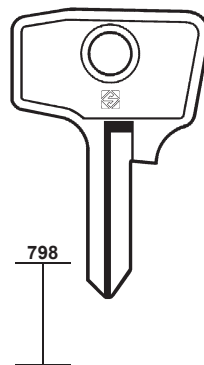
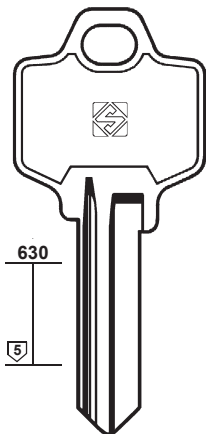
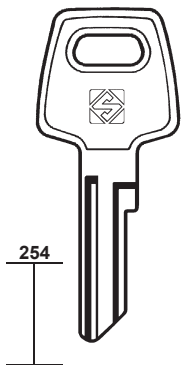

NATIONAL LOCK HARDWARE





146

PER / FOR

NEMEF (NL)

- + CES (47-48)
- + CORBIN (60)
- + RONIS (161)

NEPTUNE (GB)

NICO (DE)

- + FTH (91)
- + KVV (116)

NINO (ES)

- + TESA (181)

NITI LOCKS (JP)

- + MIWA (140)

NOBO (NO)

- + DOM (69-71)
- + VING (205)

NONES (IT)

NONFANGO (IT)

NORDWEST (DE)

- + FLORA (90)
- + SCHLECHTENDAHL (166)

NOVA (DE)

- + TOP (187)
- + YETI (219)

NOVOFERM (IT)

- + CORBIN (60)

NOVOTECNICA (IT)

- + MERONI (136)

NUMIDIA (ES)

- + ESA (77)
- + RONIS (161)

OAL (IT)

- + CORBIN
- + CORBIN (59)
- + GIUSSANI (96)

OB (IT)

- + ZANETTI A. (220)

OBEL-ODARIA (JP)

ODA (NL)

- + ANKERSLOT (17)
- + CHICAGO (51)

PER: FOR:	NEMEF	NEPTUNE	NONES
	 1627 OV NME1R NF2 NME4R NF3 NME2R NF1 NME3	 625 NP1R	 155 NN1

PER: FOR:	NONFANGO	OAL
	 33 20 PF12 PT1 PT1R	 14 15 CB1 CB1R 2-3-4-5-6-7-8-9 1-2-3-4-5-6-7-8-9 CB3 1-2-3-4-5-6-7-8-9 2-3-4-5-6-7 1-2-3-4-5-6-7-8

PER: FOR:	OAL	OBEL-ODARIA
	 54 11 11 34 OAL4 OAL4R OAL3 OAL3R OAL2 OAL2R OAL1 OAL1R	 N OB1

PER: OFFERMANS-FLOOD
FOR:

OJMAR

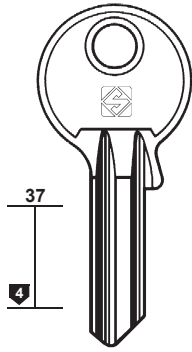

OF4

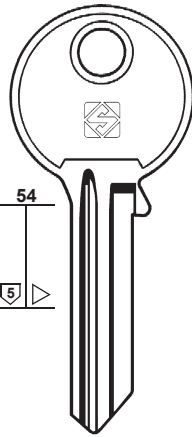

OJ2

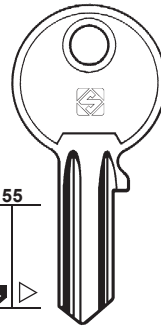

OJ1



OJ1R

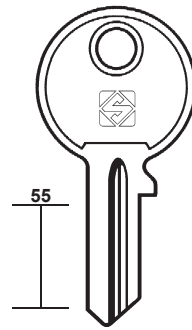

OJ3R



147

PER / FOR

OFFERMANS-FLOOD (CL)

OJMAR (ES)

BURG
METAL
MLM
MOFLEX
SISO
STUMPF

+ CES (47)
+ HR (103)

PER: OJMAR
FOR:

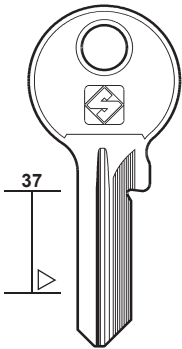

OJ16R

J



OJ4



OJ4R

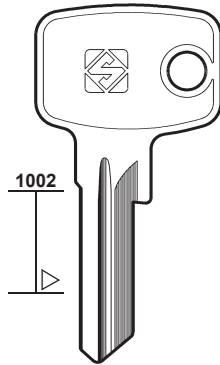

OJ5R

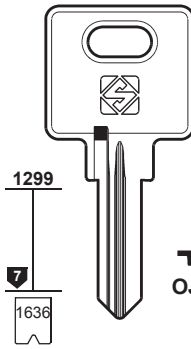

A1 ... 1-698
S ... 1-698
OJ6R
S 680



OJ8R

F 680



OJ10R

U 680



OJ9

F1



OJ11

BURG - METAL - MOFLEX
SISO - STUMPF

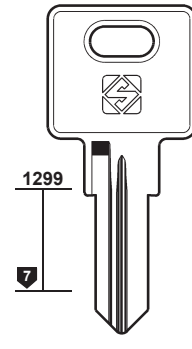

OJ12R OJ13R
Y Z

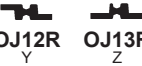

BURG - MLM

PER: OJMAR
FOR:

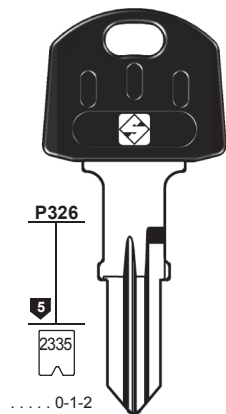

OJ15RP

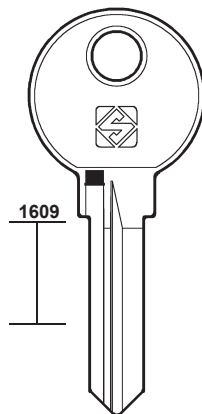

OJ17R

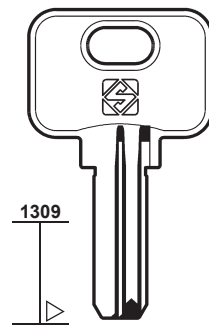

OJ14

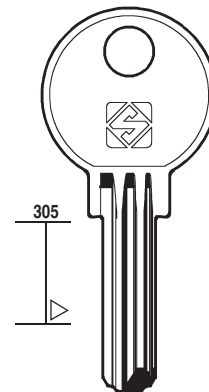

OJ18
5-Q4





148

PER / FOR

OLIVA (IT)
FERMABLOCK
PB
PREFER

OLIVETTI (IT)
CASIO
+ GIOBERT (96)

O.M.A. (IT)
C.A.R.S.

PER:
FOR:

OLIVA

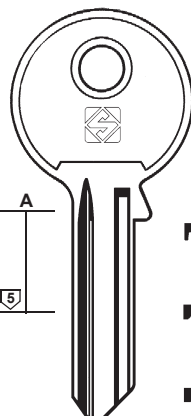
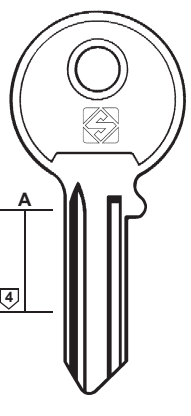





OL5



OL5R



OL4



OL4R



OL3



OL3R



OL1

OL1R

OL2



OL2R



OL6

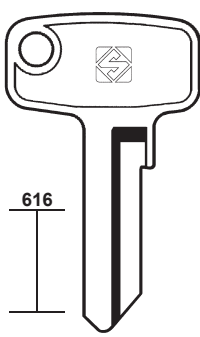
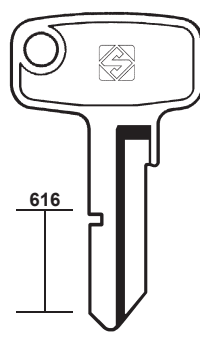

OL6R

FERMABLOCK - PB - PREFER

OLIVETTI



OLT1



OLT2



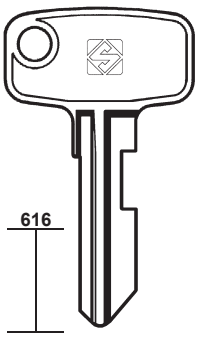
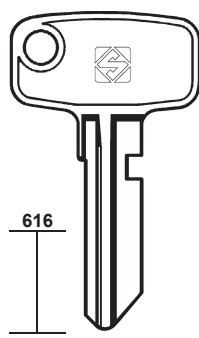
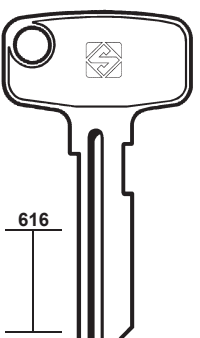
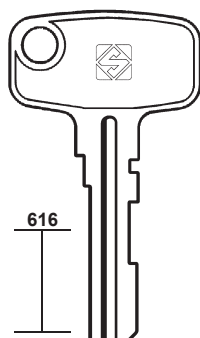

PER:
FOR:

OLIVETTI









OLT4

OLT5

OLT6R
X



OLT8R
P

 CASIO



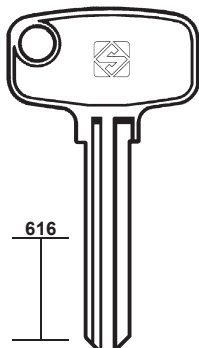
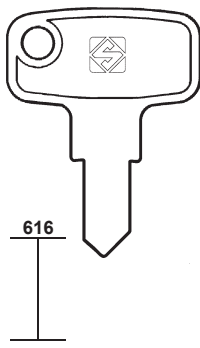

PER:
FOR:

OLIVETTI







OLT7
X

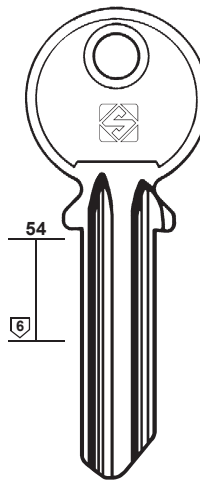
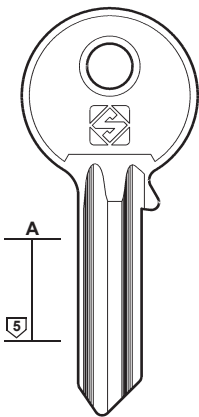
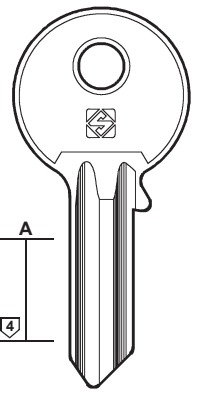

OLT3





OMA







OA1

OA1R

OA2

OA2R

OA3



OA3R

C.A.R.S.

C.A.R.S.

PER:
FOR:

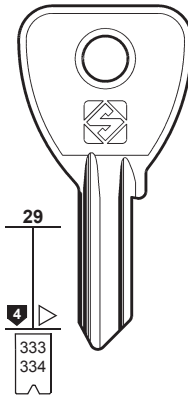
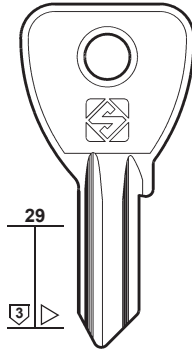
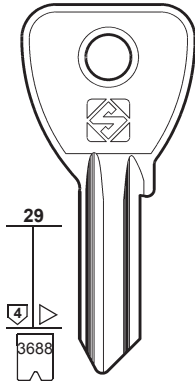
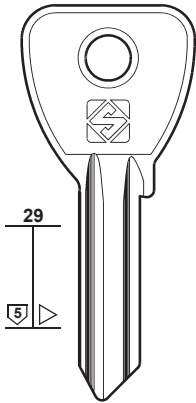
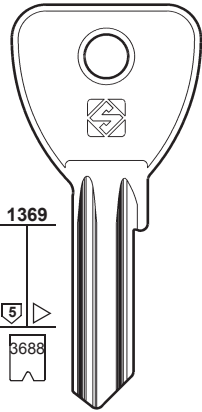
OMEK



OC5
.....
123456789



OC238



OC239



OC236



OC237



OC2



OC2R



OC1



OC1R

.....
12345



149

PER / FOR

OMEK (IT)
SANTOS

OMIV (IT)

CIB
STV
+ BIELLE (33)

O.M.R. (IT)

MICHEL-SEAT
+ HÄFELE (101)
+ MICHEL-SEAT (139)
+ POTENT (156)
+ PREFER (157)

PER:
FOR:

OMEK

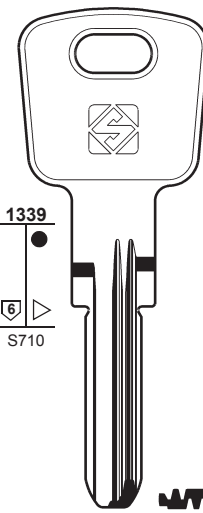
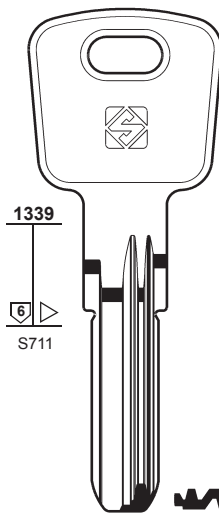
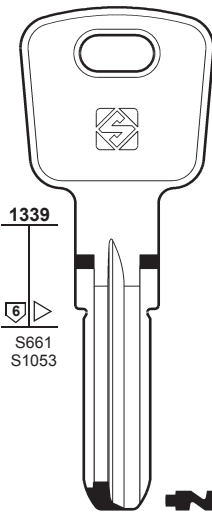
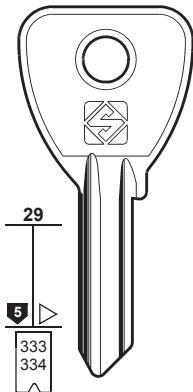

OC074



OC075

..... 1-2-3-4-5



OC3



OC4

AB
0000001-0046656



OC6

BA
0000001-0046656



SANTOS



PER:
FOR:

OMIV

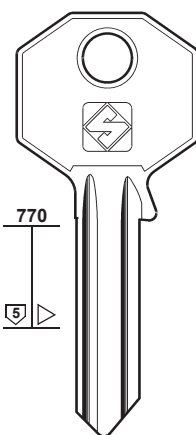
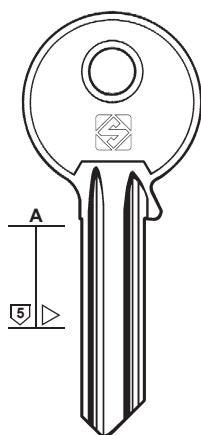
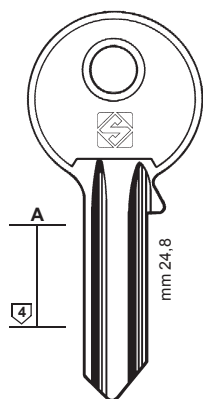

OV1



OV1R

CIB - STV



OV2



OV2R

CIB - STV



OV3



OV3R

O.M.R.

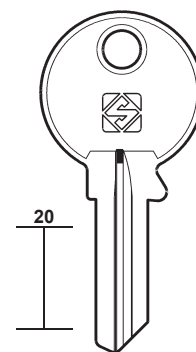
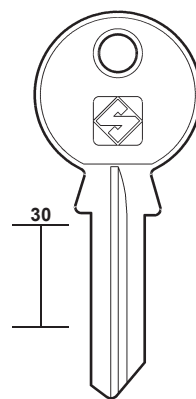

MH2



MH2R



PT1



PT1R

MICHEL-SEAT



150

PER / FOR

O.M.R. (IT)
MICHEL-SEAT
+ HÄFELE (101)
+ MICHEL-SEAT (139)
+ POTENT (156)
+ PREFER (157)

ONIUN (TWW)
UNION (193)

ORBA (DE)
SIMECA (170)

ORDO (FR)
+ KIFERM (117)
+ LAS (122)
+ MLM (141)

ORION NOVOX (FR)
DECAYEUX

ORLANDO (IT)
ICSA (105)

ORO (IL)

ORSA (BY)

OSKO (DE)
JOWIL (110)

OT (IT)
FONDAR (90)

OTHMER (DE)
ABUS (6)

OTIS (IT)
+ CES (47)
+ ILLINOIS (106)
+ ZEISS-IKON (220-221)

OTTO (IT)
BURG (43)

PACRI (BR)

PER:
FOR:

O.M.R.

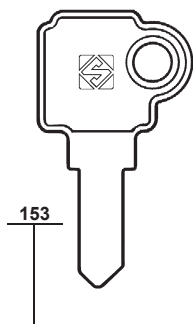

153

SEA5 SEA5R

SEA7 SEA8



MICHEL-SEAT

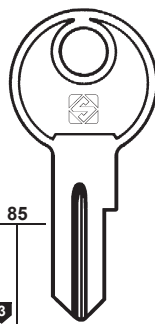

85

3

417

MET1

B... 1-600
G... 1-600

MICHEL-SEAT

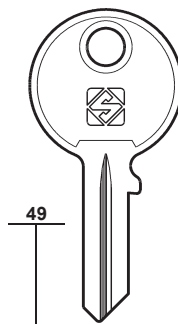

49

OMR1R



ORDO

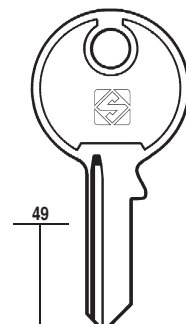

49

OR1R



PER:
FOR:

ORION NOVOX

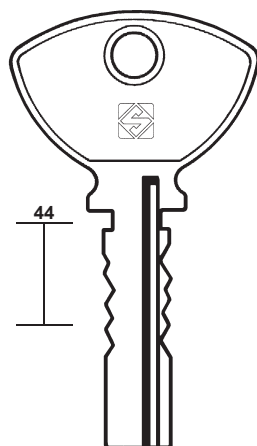

44

ON1 ON1R

DECAYEUX

ORO

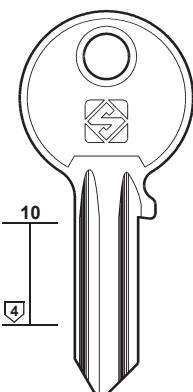

10

4

ORO1 ORO2

ORSA

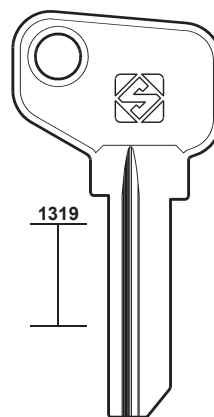

1319

ORA1

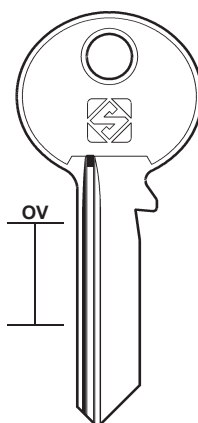

OV

ORA2

PER:
FOR:

PACRI

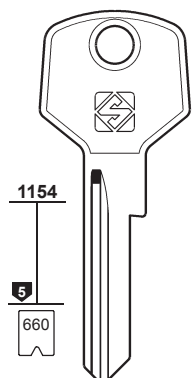

1154

5

660

..... 1-2-3-4-5-6-7

PAC1R

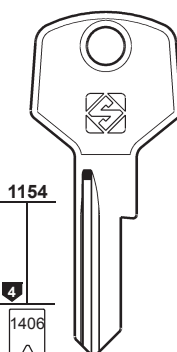

1154

4

1406

.... 1-2-3-4

PAC2R

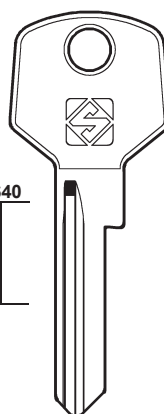

1640

PAC3R

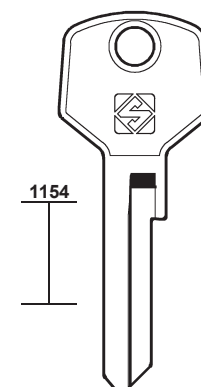

1154

PAC4

PER:
FOR:

PADO

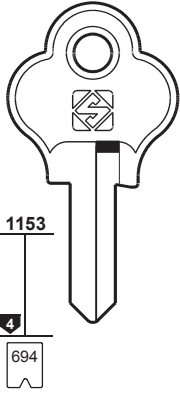

..... 1-2-3



PDO12



PDO12R

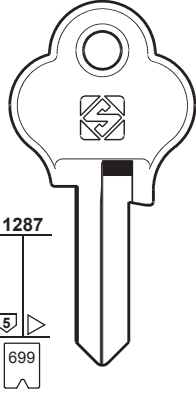

..... 1-2-3-4-5



PDO17

..... 1-2-3-4-5



PDO17R

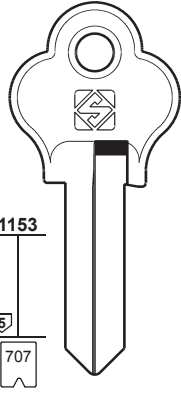

..... 1-2-3-4-5-6



PDO2

..... 1-2-3-4-5-6

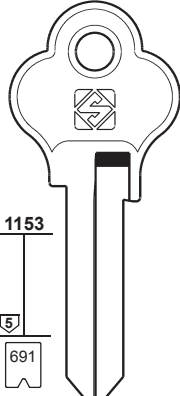

..... 1-2-3-4-5



PDO9



PDO9R



151

PER / FOR

PADO (BR)

PER:
FOR:

PADO

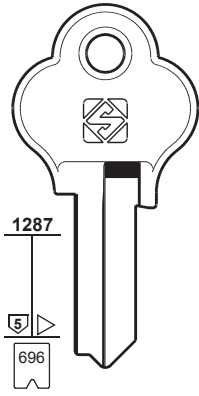

..... 1-2-3-4-5



PDO14



PDO14R

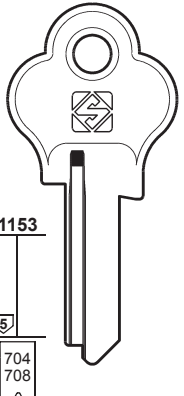

..... 1-2-3-4-5



PDO1R

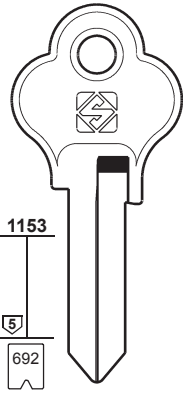

..... 1-2-3-4-5



PDO10R

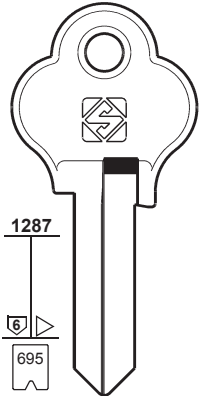

..... 1-2-3-4-5-6



PDO13



PDO13R

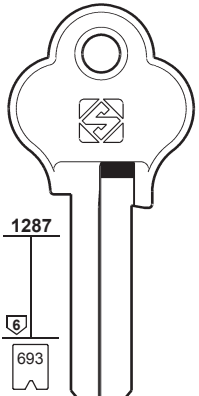

..... 1-2-3-4-5



PDO11

PER:
FOR:

PADO

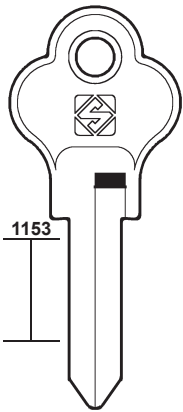

PDO22



PDO22R

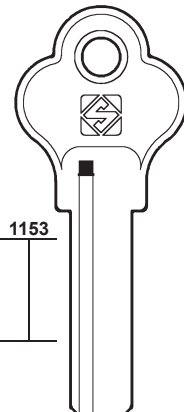

PDO23

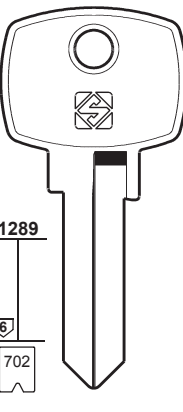

..... 1-2-3



PDO20



PDO20R

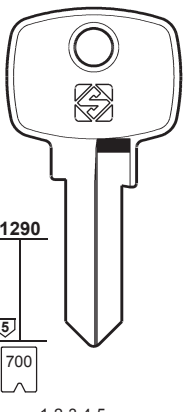

..... 1-2-3-4-5



PDO18



PDO18R

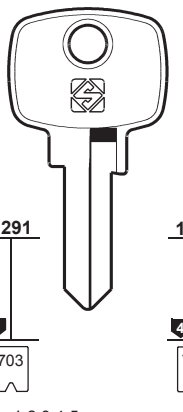

... 1-2-3-4-5



PDO21



PDO21R

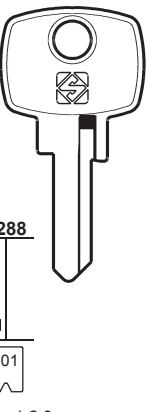

..... 1-2-3



PDO19



PDO19R



152

PER / FOR

PANDA (FR) (TW)

PANTHER (DE)



JOWIL (110)

PAPAIZ (BR)

PER: PANDA

FOR:

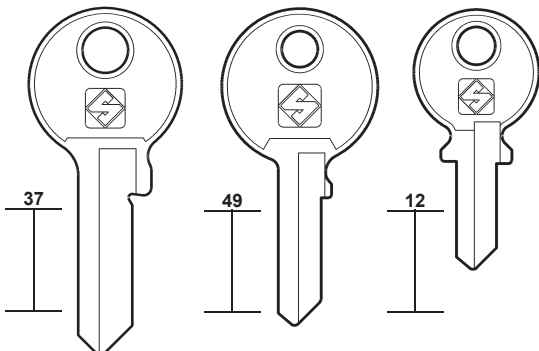

PAD3



PAD2



PAD1

PER: PAPAIZ

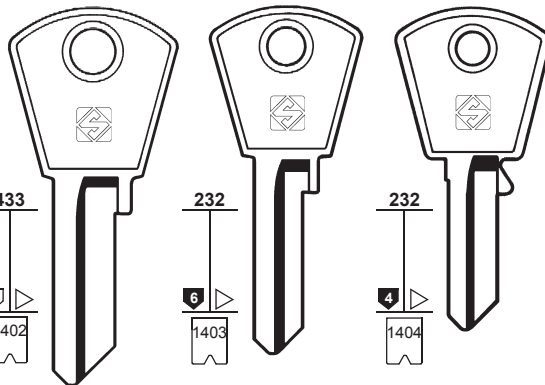

PZ1



mm 45-50-60-70



PZ2



mm 35



PZ3



mm 25-30

..... 1-2-3-4-5-6-7

..... 1-2-3-4-5

..... 1-2-3-4-5

PER: PAPAIZ

FOR:

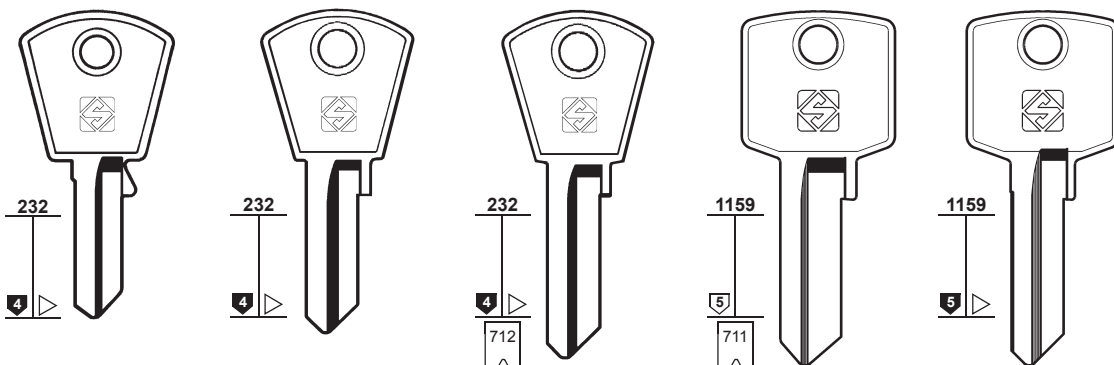

PZ4



mm 20



PZ5



PZ6



PZ7



711



PZ8

..... 1-2-3-4-5-6

..... 1-2-3-4-5-6-7-8

PER: PAPAIZ

FOR:

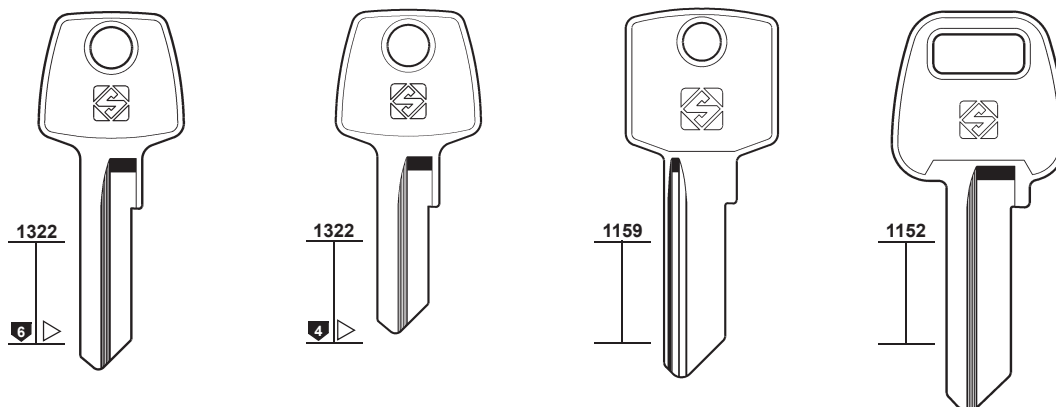

PZ9



PZ14



PZ18R



PZ17

PER:
FOR:

PAPAIZ

PARMA



153

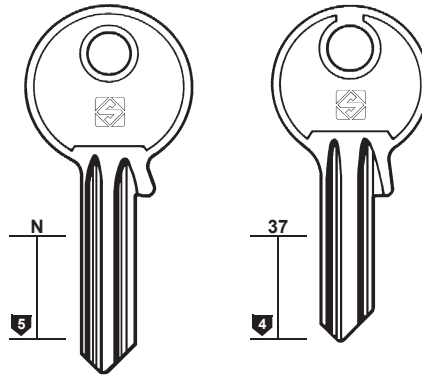
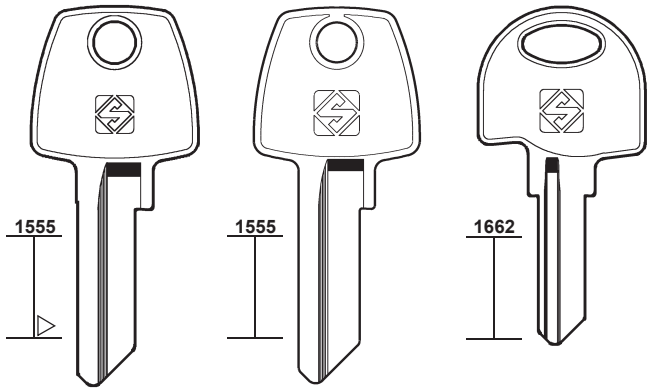

PER / FOR

PAPAIZ (BR)

PARMA (IT)

PAS (IT)

👁️ PREFER (157)

PASSY (FR)

👁️ RICOUARD (160)

PASTORE (IT)

👁️ GIUSSANI (96)

👁️ PREFER (157)

P.B. (IT)

👁️ OLIVA (148)

P.C. (CORTELLEZZI) (IT)

ETNA

FEB

FPB

FRAL

GEVY

JVAL

LUNA

PLODARI

R.S.M.

SANTOS

SAVIO

SUL

+ 👁️ BIELLE (33)

+ 👁️ JVAL (112-113)

PER:
FOR:

P.C. (CORTELLEZZI)

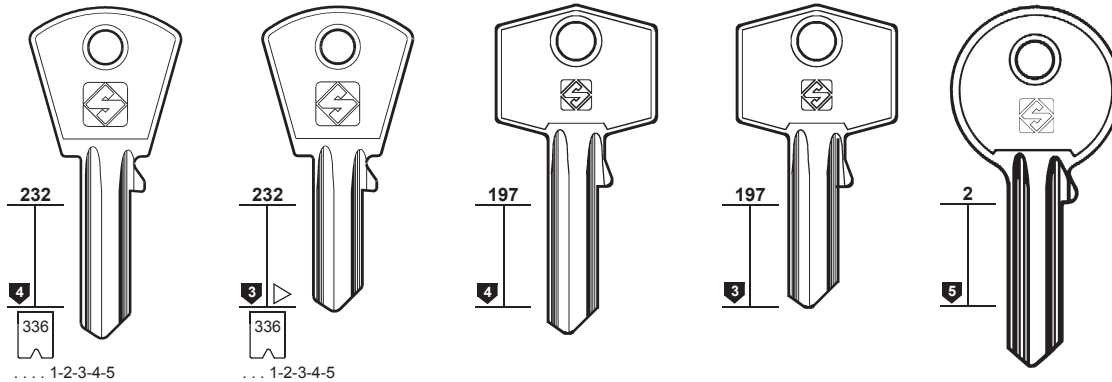

PER:
FOR:

P.C. (CORTELLEZZI)

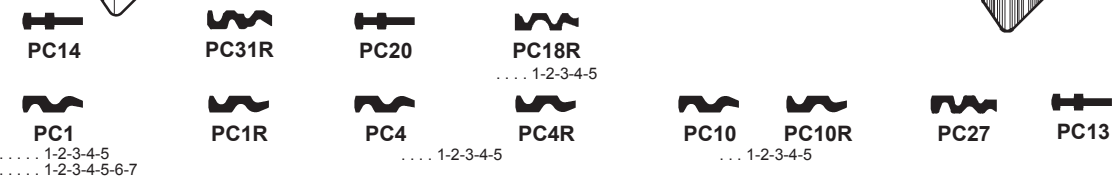
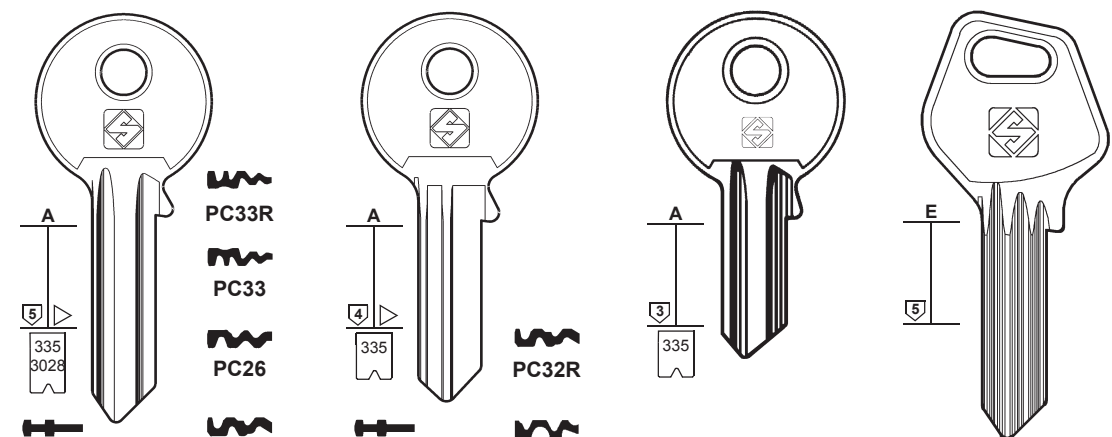

..... 1-2-3-4-5
..... 1-2-3-4-5-6-7

..... 1-2-3-4-5

..... 1-2-3-4-5

ETNA - FEB - FPB
FRAL - SANTOS - SAVIO

ETNA - FEB
FPB - LUNA - PLODARI



154

PER / FOR

P.C. (CORTELLEZZI) (IT)
 CASMA
 FEB
 JVAL
 SILCA
 + BIELLE (33)
 + JVAL (112-113)

PENZA

 (RU)

PERINO PG

 (IT)
IMSI

PEROHAUS

 (FR)

DOM (69)
 GEGE (93-94)
 JUNIE (111)

PERRIER

 (FR)

G.R. (99)

PETERBORO

 (US)

DOMINION (74)

PER: P.C. (CORTELLEZZI)

FOR:

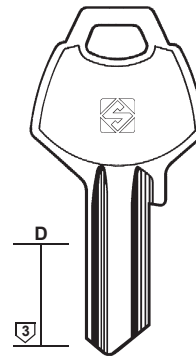
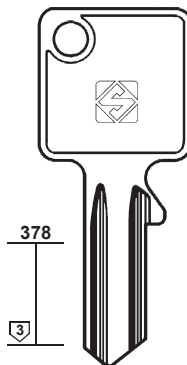
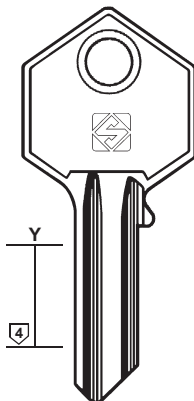
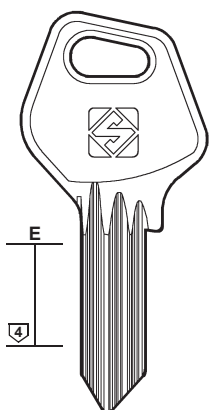

PC28



PC11



PC11R



PC5



PC5R

CASMA



PC9

CASMA

PER: P.C. (CORTELLEZZI)

FOR:

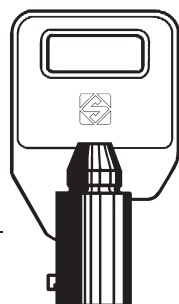

580

S251
.....
0123456

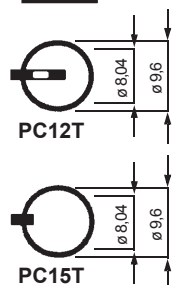

PC12T

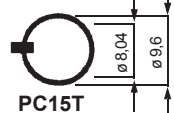

PC15T



FEB - JVAL

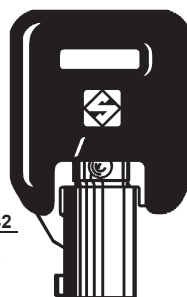

P132

S251
.....
0123456

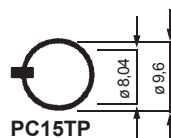

PC15TP

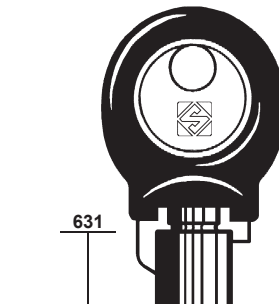

631

S251
.....
0123456

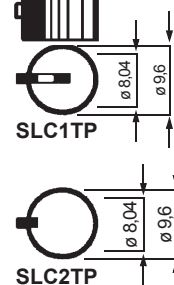

SLC1TP

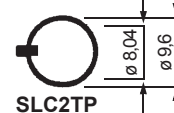

SLC2TP



SILCA

PER: PENZA

FOR:

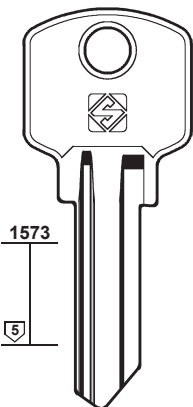

1573

5



BZ2



BZ2R

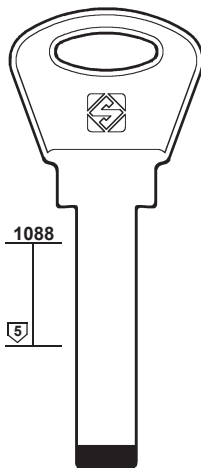

1088

5



BZ3



IMSI

PERINO PG

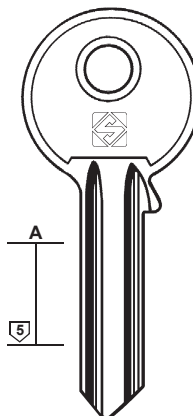

A

5



PG1



PG1R

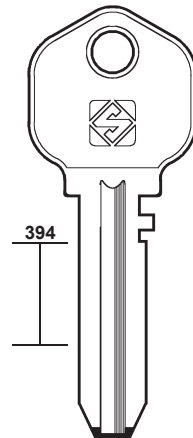

394



PN1



IMSI

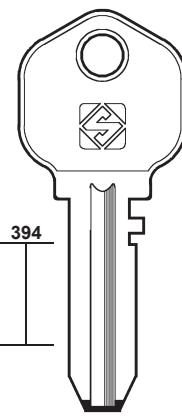

394



PN2



IMSI

PER:
FOR: **PETROZAVODSK**

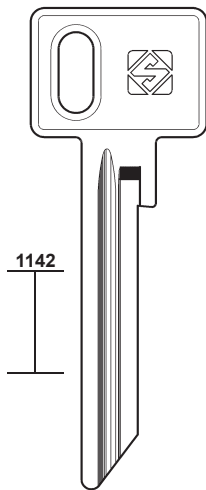

PTZ1R

PFAFFENHAIN

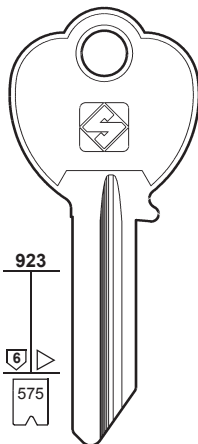

**PHF1R
HK**

..... X-Y-0-1-2-3-4-5-6-7-8-9
..... 25080-58049

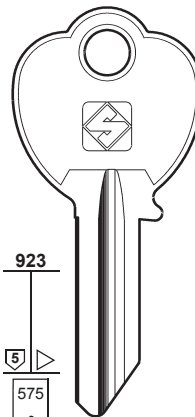

**PHF2R
L**

..... 0-1-2-3-4-5-6-7-8-9
..... 1-57036



ABUS

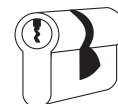

155

PER / FOR

PETROZAVODSK (RU)

PFAFFENHAIN (DE)
ABUS
BUVA

PICARD (FR)

👁️ BETA (33)
👁️ KABA (113)

PICARDIE (FR)

DECAYEUX
MODA
S & E
STS
+ 👁️ AMARO LIMITADA (16)
+ 👁️ FTH (91)
+ 👁️ GABON (93)
+ 👁️ SIS (170)
+ 👁️ TITAN (182)

P.J. (FR)

👁️ RONIS (161)

P.K. (FR)

👁️ LAS (121)

PLG (IT)

👁️ GIUSSANI (96)

PLODARI (IT)

👁️ P.C. (153)

PM (FR)

👁️ RONIS (161)

POLI (CL)

POPLOCK (IT)

👁️ CORBIN (59-60)

POS (DE)

SIGENIA

PER:
FOR: **PFAFFENHAIN**

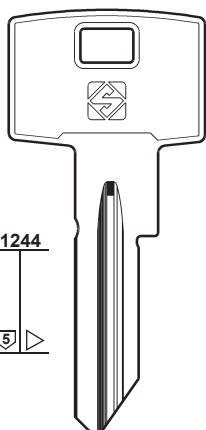

PHF37

PHF28R

PHF29

PHF11R

PHF15

PHF10R

PHF12

PHF9R

PHF6

PHF8R

PHF4R

PHF5

PHF7R

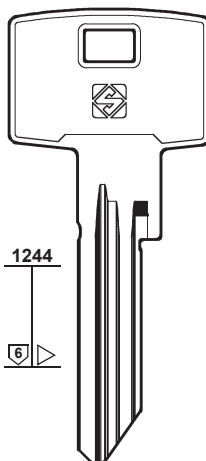

PHF34

PHF32

PHF23

PHF22R

PHF27R

**PHF19
EA**

PHF27

**PHF18R
FD**

PHF26R

**PHF16R
SRA**

**PHF17
ED**

PHF26

ABUS - BUVA

PER:
FOR: **PICARDIE**

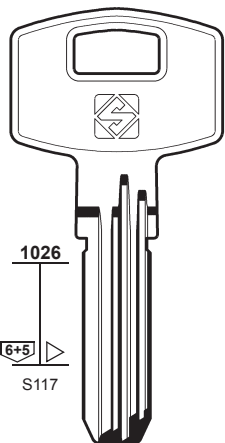

PIC1

DECAYEUX - MODA
S & E - STS

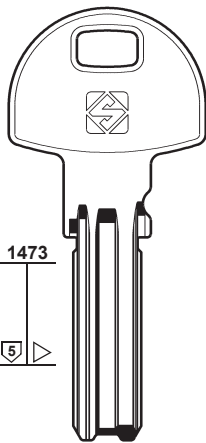

PIC2

POLI

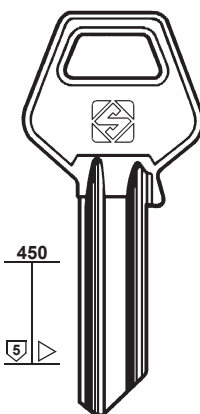

PL1

POS

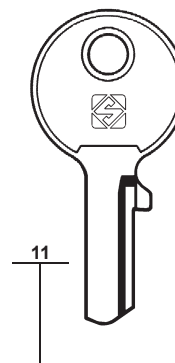

**PS1
CZ**

SIGENIA



156

PER / FOR

POTENT (IT)

AM
MICHEL
NONFANGO
O.M.R.
+ MICHEL (139)

PREFER (IT)

+ OLIVA (148)
+ TRAU (188)

PER:
FOR:

POTENT

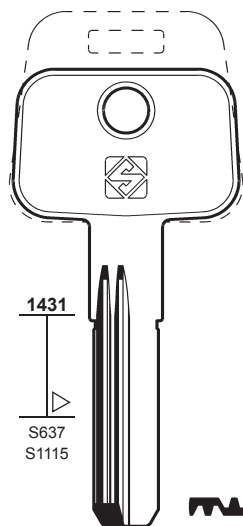

1431
S637
S1115



PT4R
..... 1-2-3-4-5

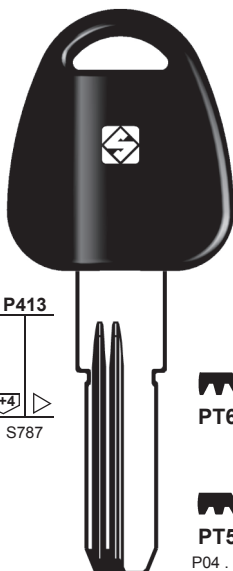

P413
S787



PT6RP



PT5RP
P04
1-2-3-4-5-6

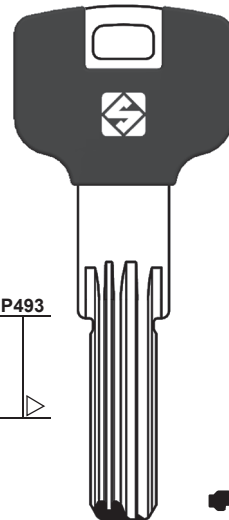

P493



PT7RAP

PER:
FOR:

POTENT

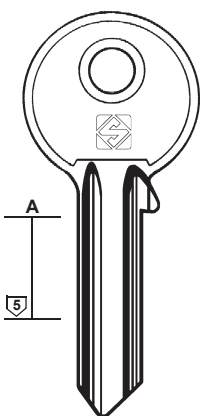

A
5



PT2

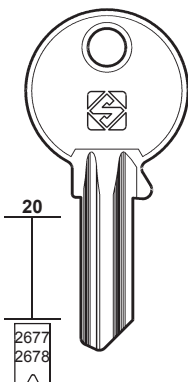

20
2677
2678



MH1
..... 201-436



MH1R
..... 437-672



MICHEL

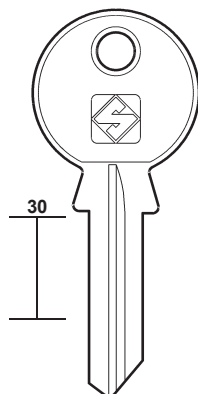

30



MH2



MH2R

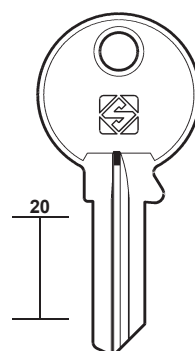

20



PT1



PT1R



AM
MICHEL
NONFANGO

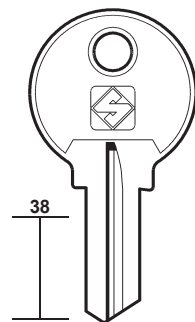

38



MH4



MH4R



MICHEL
O.M.R.

PER:
FOR:

PREFER

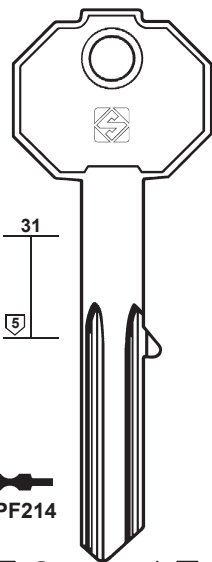

31
5



PF214



PF215

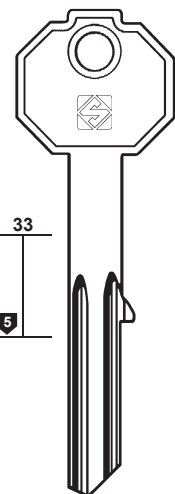

33
5



PF215R



PF3



PF3R

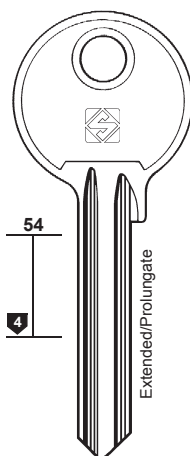

54
3 4



PF11



PF11R

Extended/Prolungate

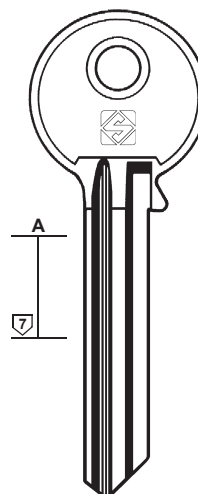

A
7



PF7



PF7S

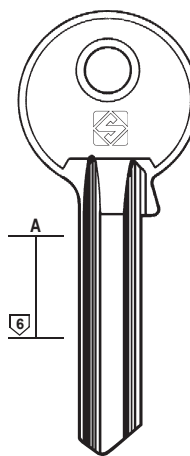

A
6



PF8



PF8R

PER:
FOR:

PREFER

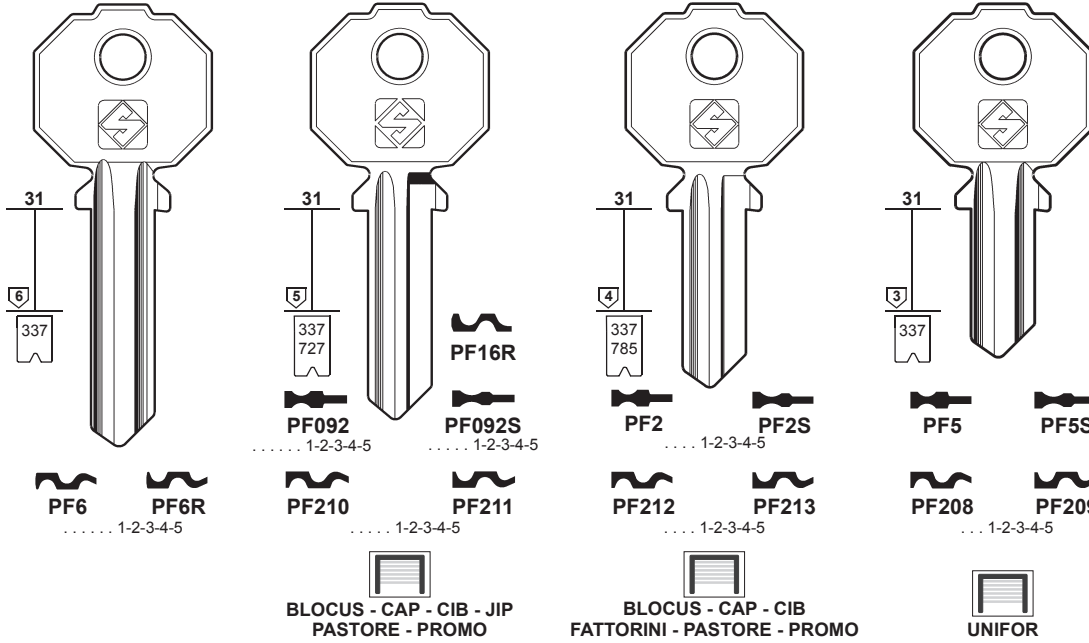

157

PER / FOR

PREFER (IT)

- BLOCUS
- CAP
- CIB
- FATTORINI
- FOSAM
- JIP
- LIPS VAGO
- METACASTELLI
- NONFANGO
- O.M.R.
- PAS
- PASTORE
- PROMO
- SERITAL
- SWEDA
- UNIFOR
- + OLIVA (148)
- + TRAU (188)

PER:
FOR:

PREFER

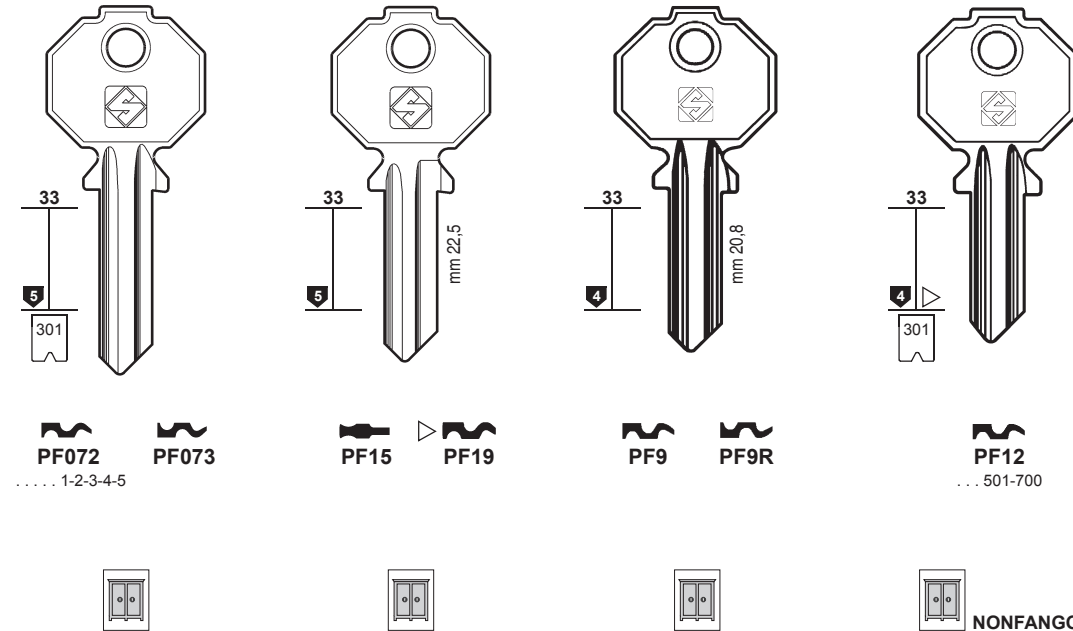

PER:
FOR:

PREFER

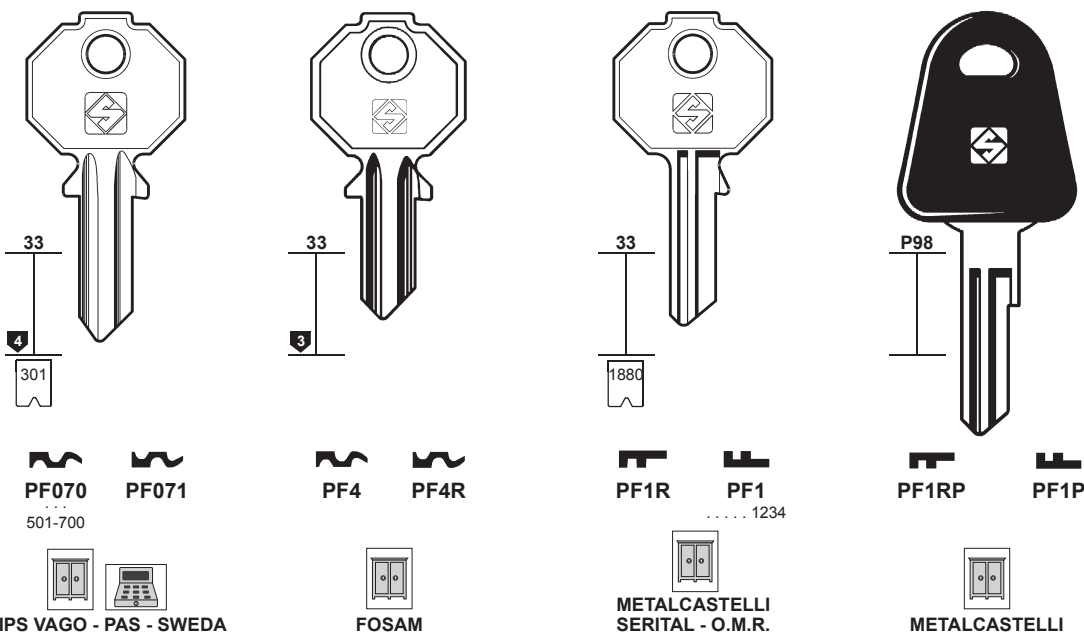



158

PER / FOR

PREFER (IT)

- IMBAC
- + OLIVA (148)
- + TRAU (188)

PRESTA (DE)

- BOMORO (37)
- LA PORTE (121)

PRIM (CH)

SWEDA

PRIVE (AR)

- YALE (212)

PROBAT (FR)

- FTH (91)

PROFILMAR (FR)

PROMECA (FR)

- RONIS (161)

PROMETA (IT)

PROMO (IT)

- PREFER (157)

PROTEC (FR)

- CITY (58)
- KVR (119)

PUNDRA (US)

QCP (FR)

- CITY (58)
- ZENITH (222)

RABBIT (HK)

RAFI (DE)

- DOM (69)

RAM (TW)

- YETI (218-219)

RAMIS (EG)

RAUCO (DE)

- HEKNA (102)

R.C. (IT)

- CRISTANI (63)

READING (US)

- SEGAL (167)

RECA (IT)

- INDESIT (107)

REDY (IN)

- LOB (126)

REGAL (GB)

REGENT (US)

- HEKNA (102)
- HENDERSON (102)
- SIDLEEN (169)

PER:
FOR:

PREFER

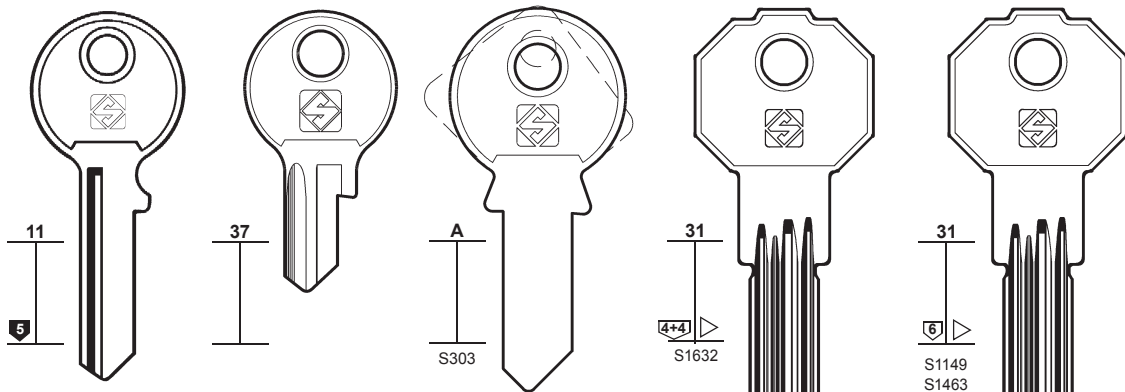

PF13R

PF14

PF18

PF22

PF20

PF21



IMBAC



PER:
FOR:

PRIM

PROFILMAR

PROMETA

PUNDRA

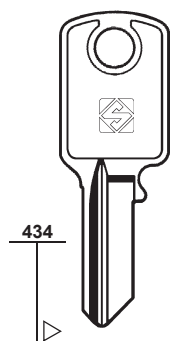

PRI3R



SWEDA

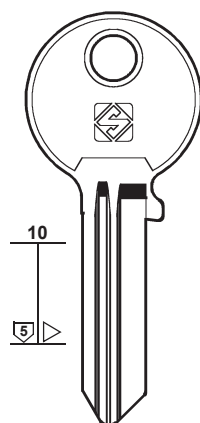

PRL1

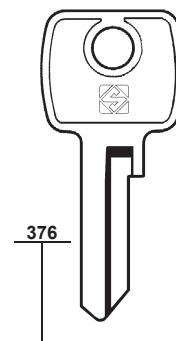

PM1

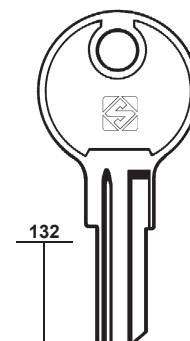

PD1

PER:
FOR:

RABBIT

RAMIS

REGAL

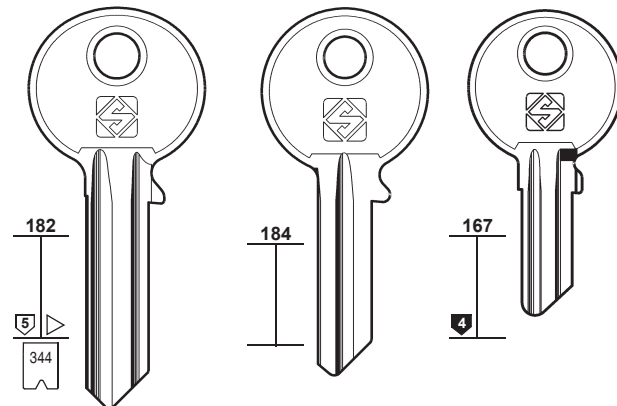

YA1

YA1R

RBT1R

RBT2

0-1-2-3-4-5-6-7-8-9

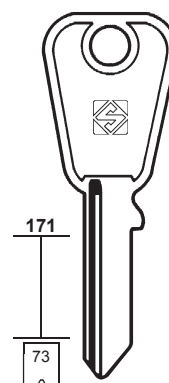

UNI12
FP ...
626-750

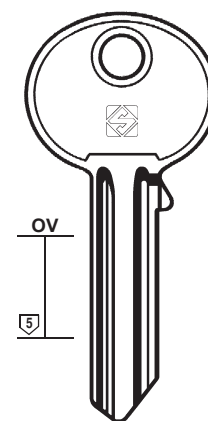

RG1

PER:
FOR:

**REGISTRATORI
DI CASSA**

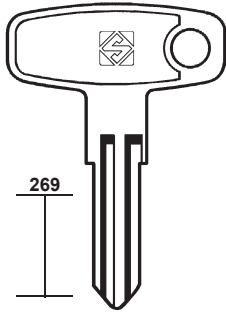

269



**RDC1
Z**



RELIANCE

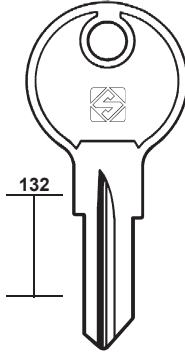

132



REL1R



REL2

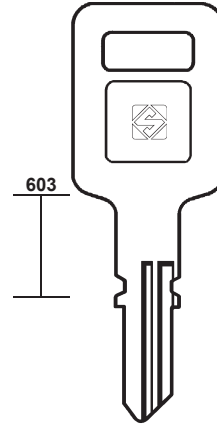

603



REL3



159

PER / FOR

**REGISTRATORI DI
CASSA (IT)**

RELIANCE (JP)

REMO (IT)
+ ICSA (105)

RENZ (DE)
ATAL
+ KIFERM (117)
+ LAS (121)

PER:
FOR:

RENZ

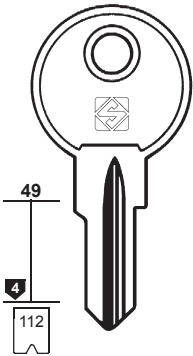

49



KI5

C... 1-275
XS... 1-275

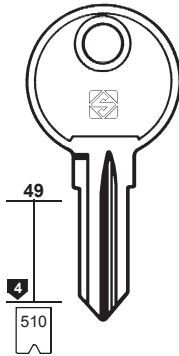

49



KI5R

SX... 1-275
XT... 1-75
RX... 1-275

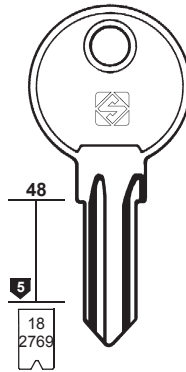

48



KI12

... 151-218
... 101-150
... 1116-7776
H... 1116-7776
E... 425-499



KI12R

... 1-68
... 51-100
H... 500-574
E... 1116-7776



LS1

R... 1-224



LS1R

V... 1-224

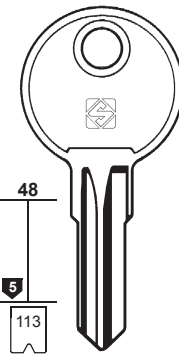

48



LS2

AX... 1-224



KI7

XY... 1-275

ATAL



PER:
FOR:

RENZ

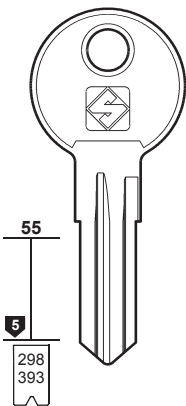

55



REN1



REN1R

... 1-200

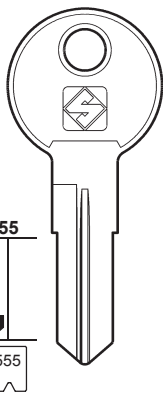

55



REN2



REN2R

32... 001-200

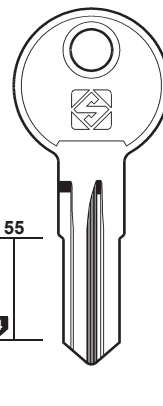

55



REN3R

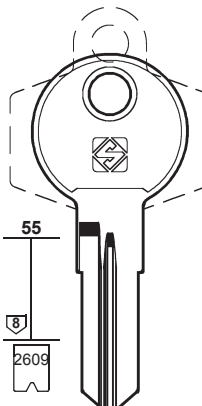

55



REN5

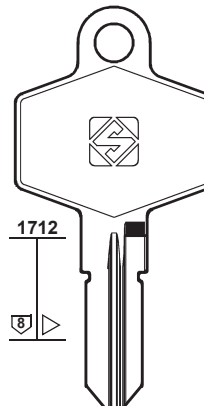

1712



REN6



REN6R





160

PER / FOR

RESMINI (IT)

REX (DK)

RGM (ES)

RICOUARD (FR)

COUILLET

DECAYEUX

KIFERM

LAS

PASSY

YVEL

RIGA (LV)

RIPA (ES)

IFAM (105-106)

RIQUIER (FR)

G.R. (99)

RIV (ES)

UCEM (192)

RIVERS (AU)

RJAZAN (RU)

ROC (FR)

YALE (212)

ROLEX (GR)

ZANETTI A. (220)

ROLL-A-DOOR (GB)

LEN-LOK (122)

L & F (129)

ROMA (IT)

RONEO (ES)

RONIS (161)

PER:
FOR:

RESMINI

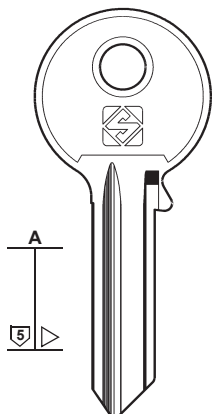

A
5



RM1A

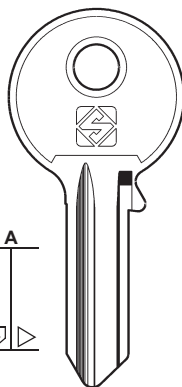

A
4



RM1RA



RM2A



RM2RA

REX

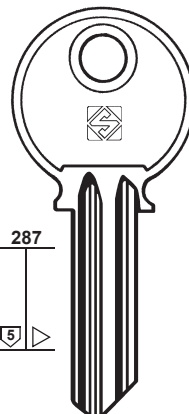

287
5



RX2

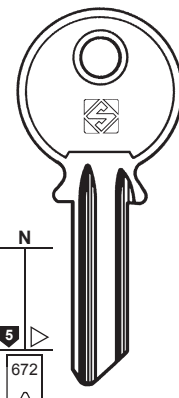

N
672



RX1

K...1-50

PER:
FOR:

RGM

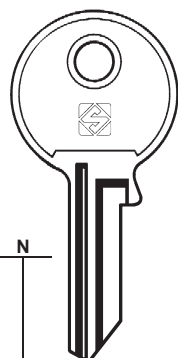

N



RGM1



RGM1R

RICOUARD

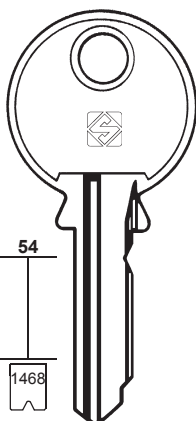

54
1468



RIC1

K...726-950

COUILLET - DECAEUX
KIFERM - LAS - PASSY - YVEL

RIGA

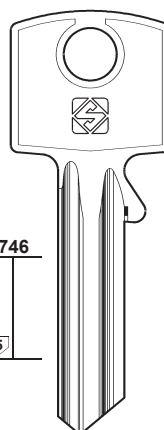

746
5



RGA1

RIVERS

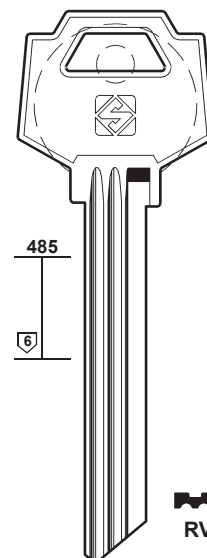

485
6



RV1

PER:
FOR:

RJAZAN

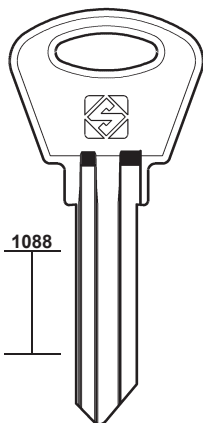

1088



RZA1

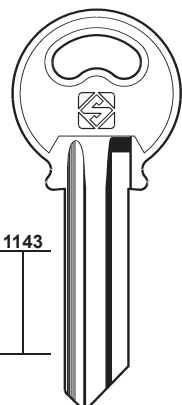

1143



RZA2

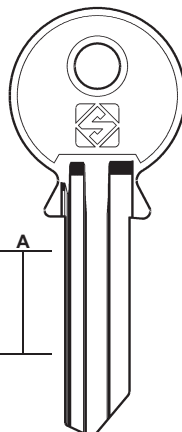

A



RZA3

ROLL-A-DOOR

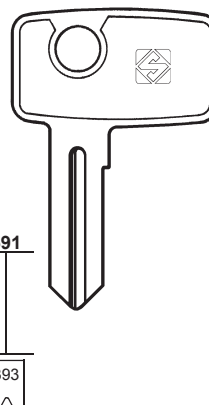

591
393



RD1



RD2

19...1-420

ROMA

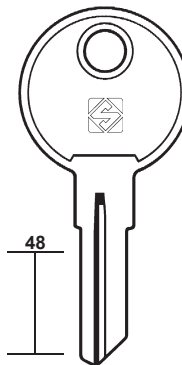

48



RA1



RA1R

PER:
FOR:

RONIS

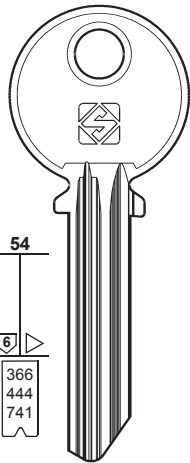

K
KK
N
NN
123456789

RO9 RO9R
ANTAR
LAPERCHE - SESA

UUL
RO23 RO23R
FL
LAPERCHE

UUK
RO25 RO25R
FK
LAPERCHE

UUM
RO27 RO27R
FM
LAPERCHE

RO47 RO47R

..... 1-1296
V20 1-1296
..... 1234567890
A/Z 1234567890

RO41 DAD

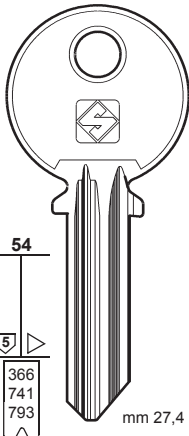

MX 1100-1699
A/Z 12345678
..... A/Z 12345678
..... 123456789
BLOCUS 9 123456789
CATOR J 123456789

DC
DEBEAURAIN
DELTA
DERLOCHE
DESPREZ
EMGE
EMHART
EQUIBATIR
FONTAINE
FORINDEX
GOLLOT
GUIDOTTI
JIP
LAPERCHE
LIONA-LIOX
MAFOR
MONDIAL
MOREAUX
NUMIDIA
PM
PROMECA
SESA
SOFRANQ
STREMLER
VEGA

TTL
RO22 RO22R
FL
LAPERCHE

TTK
RO24 RO24R
FK
FONTAINE
LAPERCHE

TTM
RO26 RO26R
FM
LIONA-LIOX
LAPERCHE

RO37 RO37R
ET

.....
0-1-2-3-4-5-6-7-8-9

RO8R
..... 9 123456789
..... N 123456789

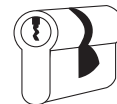

161

PER / FOR

RONIS (FR)

ANTAR
BLOCUS
ARMOR
CATOR
DAD
DAV
DC
DEBEAURAIN
DELTA
DERLOCHE
DESPREZ
EMGE
EMHART
EQUIBATIR
FONTAINE
FORINDEX
GIMM
GOLLOT
GUIDOTTI
JIP
KARDEX
LAPERCHE
LIONA-LIOX
MAFOR
MLM
MONDIAL
MOREAUX
NEMEF
NUMIDIA
P.J.
PM
PROMECA
RONEO
SANEL
SCHÄFER
SESA
SOFRANQ
SOLOR
STRAFOR
STREMLER
VEGA
YAC

+ EMKA (77)
+ LAS (121-122)
+ VACHETTE (199)

PER:
FOR:

RONIS

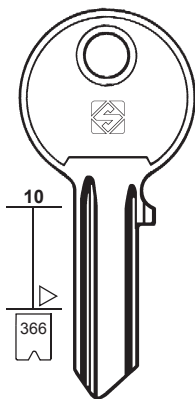

RO7 RO7R
..... 0-1-2-3-4-5-6-7-8

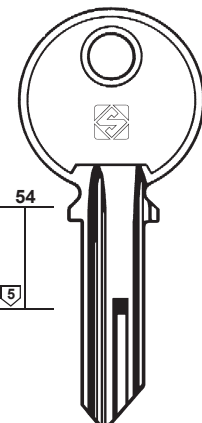

RO13

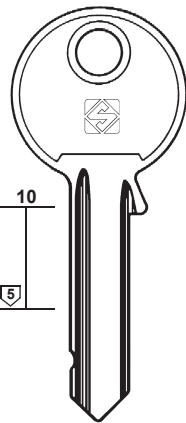

RO14

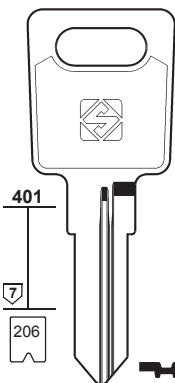

RO67
NA
4001-5000

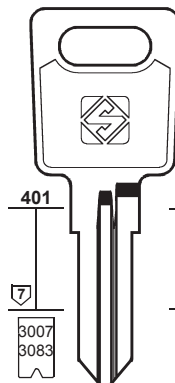

RO67R
ND
4001-5000

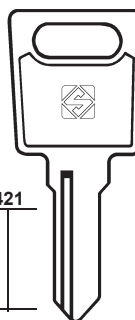

RO69
CC 1-2000

RO46R

ANTAR - GIMM
JIP - LAPERCHE
PM - SESA

SOLOR

CATOR

RO68
NC
4001-5000

RO68R
NB
4001-5000

RO85

PER:
FOR:

RONIS

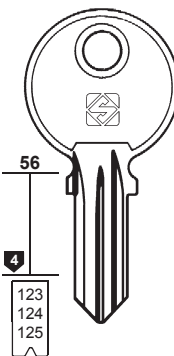

RO15 RO15R
A8 ... AA-DS
... 8 AB-ZZ
S ... 385-402

P.J.

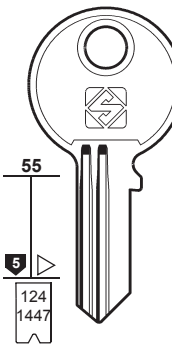

RO4
D 1-1000
S 1-106
T 1-106
... 11 1-200
A ... A 1-200
F 1-200
1F ... 1-21
TA ... 1-224
PS ... 1-30
GV ... 1-300
... F 1-500
... C 101-600
C ... 101-600
C ... 11111-44444
... A ... 12345
00 ... 12345
C ... 12345
T ... 313-380
... 11 501-700
A ... A 501-700

RO45

EMHART - MLM
NEMEF - SCHÄFER

RO4R
E 1-1000
... 15 1-200
... Y 101-600
Y ... 101-600
S ... 107-212
T ... 107-246
Y ... 11111-44444
Y ... 12345
1F ... 22-29
T ... 381-400
... 15 501-700

RO48R

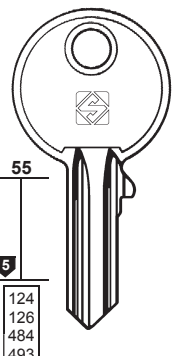

RO20
E 12345
2 12345
F 12345
S 247-279
T 247-279
1F ... 30-33
... 400-520
2 ... 400-520
... E 601-800
E ... 601-800

RO30
F ... 1-500
Z ... 1-900

RO38

RO42

RO50
B ... 1-20

RO20R
A ... 12345
S ... 280-312
T ... 280-312
... A 400-520
... A 601-800
A ... 601-800
EMKA

RO30R

RO38R
H ... 1-1000

RO42R
... ZA1-ZZ3



ARMOR - DAV - FORINDEX - KARDEX
RONEO - SANEL - STRAFOR - YAC



162

PER / FOR

RONIS (FR)

- BURG
- STRAFOR
- TAV
- + EMKA (77)
- + LAS (121-122)
- + VACHETTE (199)

ROSSETTI (RO)

ROSTEX (CZ)

- LOB (125)

ROYAL (TW)

- ABUS (8)
- COLE (59)
- GUARD (100)
- VIRO (206)
- YETI (218-219)

R.S.M. (GB)

- P.C. CORTELLEZZI (154)

RUFFLER & DEITH (GB)

- SIDLEEN (169)

RUFFLER & WALKER (GB)

- SIDLEEN (169)

RUKA (DE)

- DOM (68)
- VACHETTE (198)

RUKO (DK)

- ASSA
- DIFA

PER:
FOR:

RONIS

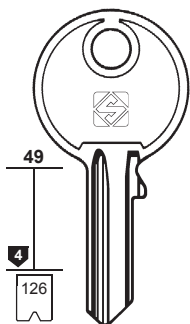

RO44



RO34

N... 601-983



RO21

... 601-983

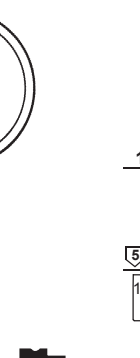

RO44R



RO34R

P... 601-983



RO21R

M... 601-983

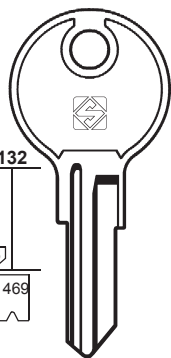

RO49



RO51

CH... 101-751
GZ... 101-751

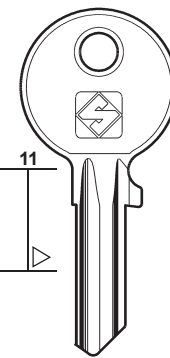

RO53R



RO84

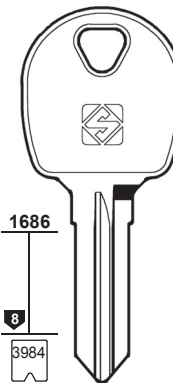

RO84

..... 12345

BURG - STRAFOR - TAV



PER:
FOR:

ROSSETTI

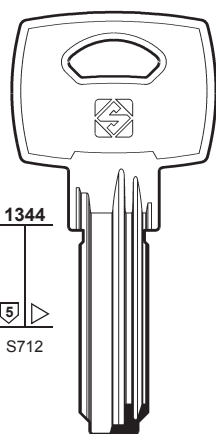

... 1-2220



RSS3



ROYAL

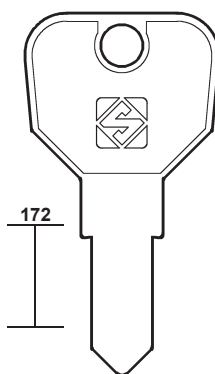

ROY1

RUKO

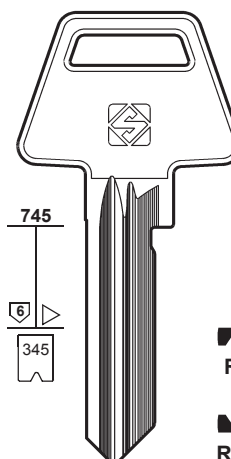

RU25



RU25R



RU14

..... ABCDEFGHJ



RU24R

ASSA



RU26



RU27

PER:
FOR:

RUKO

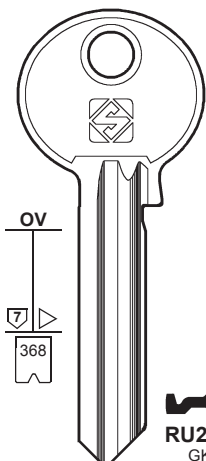

RU29R
GK



RU6

1-2-3-4-5-6-7-8-9-A-B-C



RU23R
GM

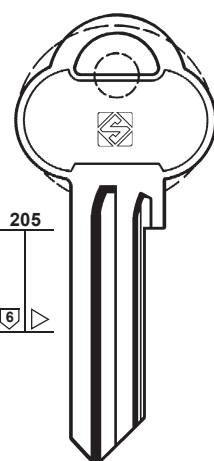

RU15R

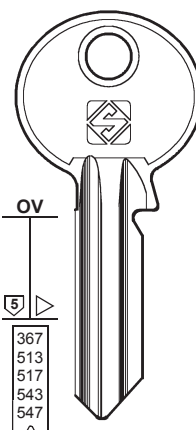

RU1

..... 1-2-3-4-5-6-7-8
..... 1-2-3-4-5-6-7-8-9
..... 1-2-3-4-5-6-7-8-9-0-A-B
..... 0-1-2-3-4-5-6-7-8-9-A-B-C-D-E-F-G-H-L-M
S..... 1-2-3-4-5-6-7-8-9



RU1R



RU2R



RU2



RU16



RU19



RU3R



RU3



RU20
HNR



RU21
ALR



RU4



RU4R



RU22R
GMR



RU5



RU5R



RU28



RU7



RU30
TL



RU8R
GC



RU9R
GK



RU10R
GL



RU11R
GM



RU12
AK



RU13
AM

DIFA

PER:
FOR:

RUSSIA

RUSSWIN



163

PER / FOR

RUSSIA (RU)

RUSSWIN (US)

S-TECH (GB)

SAB (IT)

TAMPALINI (179)

SABI (EG)

SAFE (IT)

SAM (RU)

SAMA (FR)

FTH (91)

SAMSONITE (US)

SANCHUN (TW)

YETI (218-219)

SANEL (FR)

RONIS (161)

SANPEUR (FR)

VACHETTE (198)

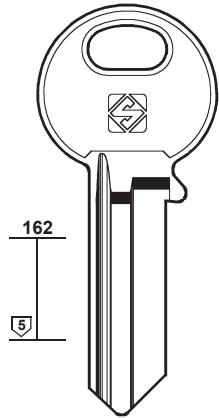

RUS4

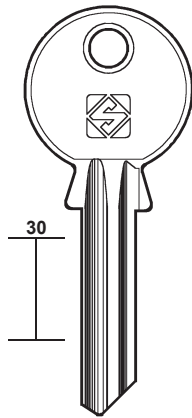

RUS5

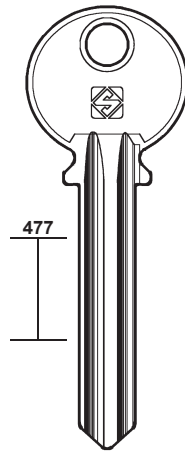

RUS6

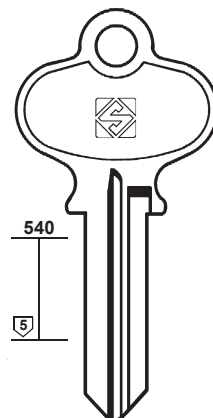

RW7R



RW25



RW8R

S-TECH

SABI

SAFE

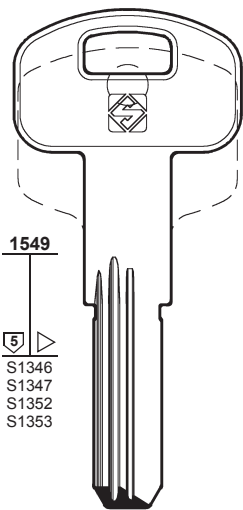

S1346
S1347
S1352
S1353



SCH1R

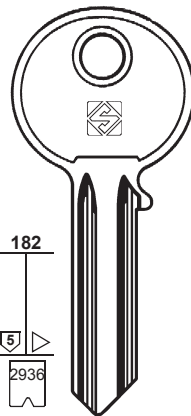

2936

.....01234567



SB1

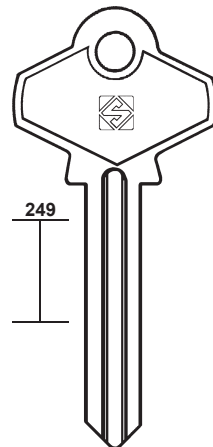

SF1

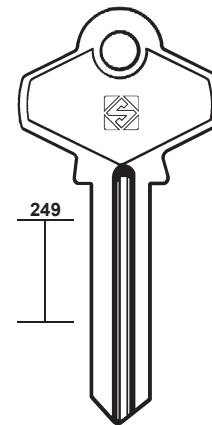

SF2

SAM

SAMSONITE

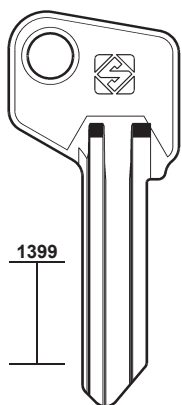

SMA1

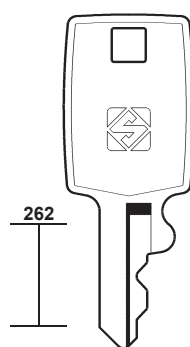

SA1
170 S



SA1R



SA2
70 S



SA2R

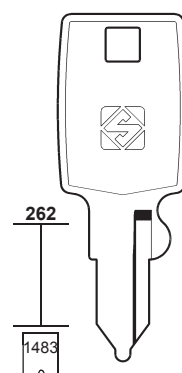

SA4
SE... 41-186



SA3
SE... 315-396



SA3R
SE... 231-294



SA5



SA5R





164

PER / FOR

SÄNTIS (CH)
+ CES (47)

SANTOS (PT)
 OMEC (149)
 P.C. (CORTELLEZZI) (153)

SANWA (JP)

SANY (FR)
 ALPHA (16)

SARATOV (RU)

SARGENT (US)

PER: FOR: SÄNTIS

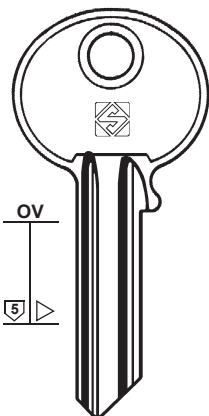

SANWA

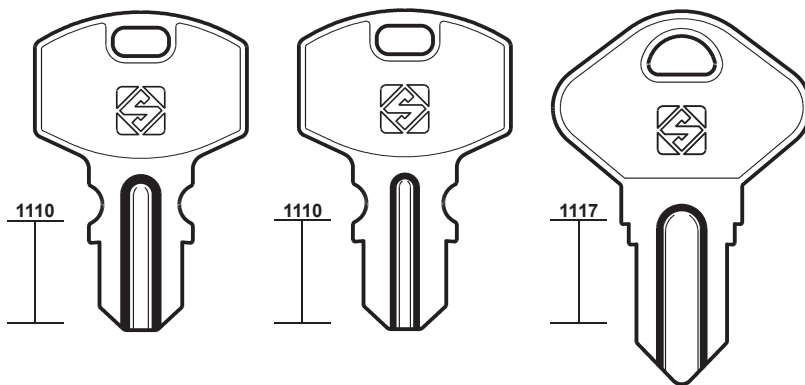

PER: FOR: SARATOV

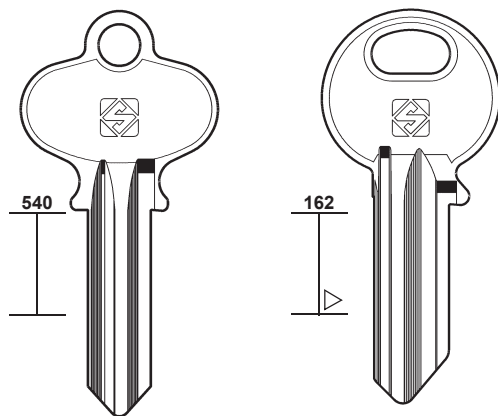

SARGENT

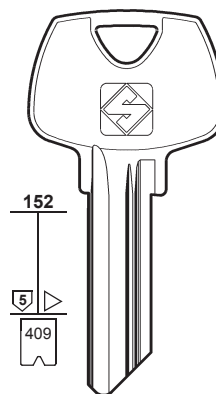

.....
1-2-3-4-5-6-7-8-9-0

PER: FOR: SARGENT

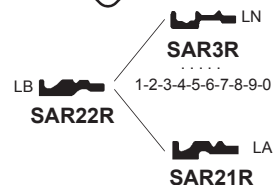
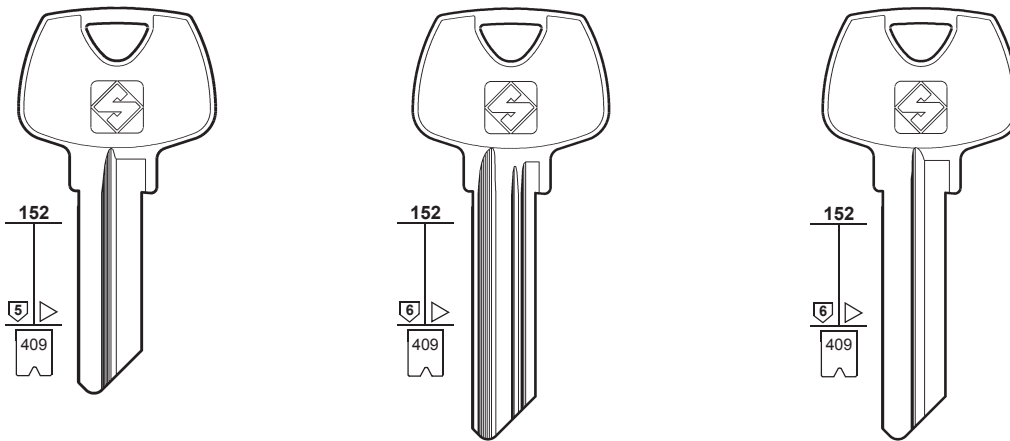

PER:
FOR:

SARGENT

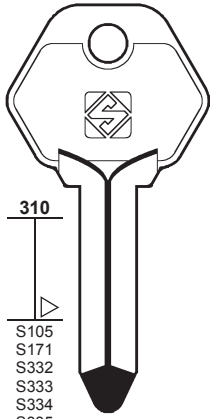

310

S105
S171
S332
S333
S334
S335
S336
S598
S599
S600
S601



KE4



KESO

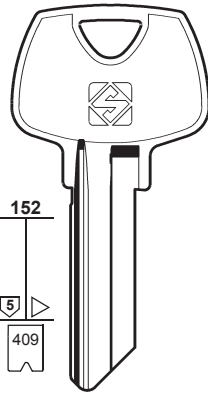

152

5
409



SAR1

S

1-2-3-4-5-6-7-8-9-0

BRICARD - SHOWA

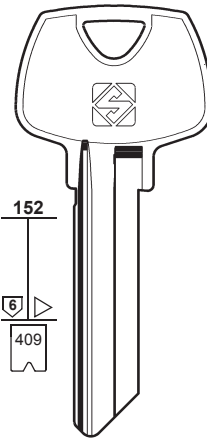

152

6
409



SAR2

S



SAR4R

1-2-3-4-5-6-7-8-9-0

BRICARD - SHOWA



165

PER / FOR

SARGENT (US)
BRICARD
KESO
SHOWA

SARGENT & GREENLEAF (US)
SLAYMAKER (171)

SATURN (SI)
BASI
GERA
VERA

SAVE (CZ)

SAVIO (I)
AGB (11-12)
JVAL (112)
P.C. (CORTELLEZZI) (153)

SCHÄFER (DE)
RONIS (161)

SCHÄRF (DE)
HUWIL (104)

SCHLAGE (IT) (US)
EPO

PER:
FOR:

SATURN

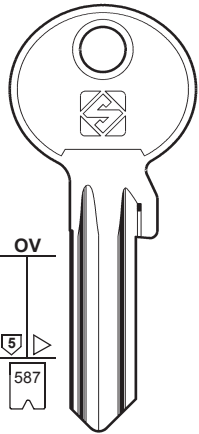

OV

5
587



STU1

1-2-3-4-5-6-7-8-9

GERA - VERA

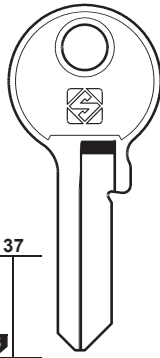

37

5



STU3



mm 50

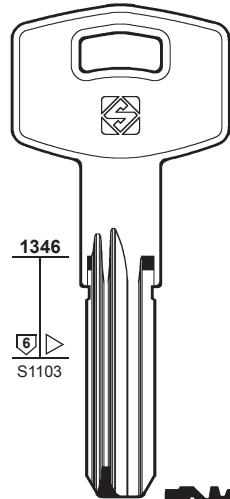

1346

6
S1103



STU6R



BASI

SAVE

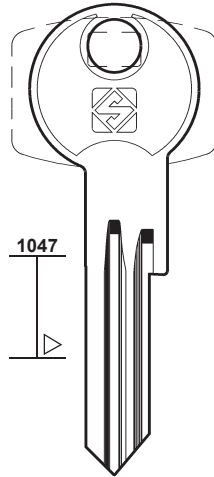

1047



SVE1R

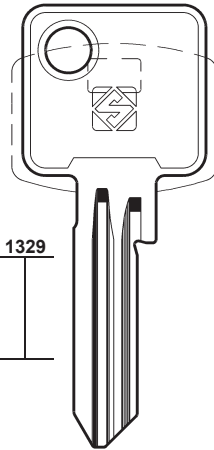

1329



SVE2R

PER:
FOR:

SCHLAGE

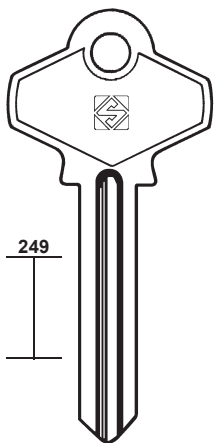

249



SH1

A

EPO

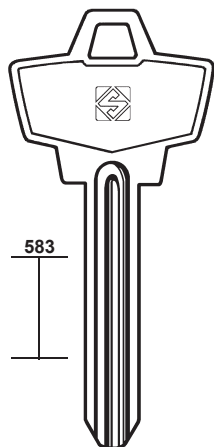

583



SH2

W

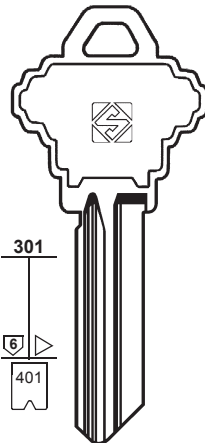

301

6
401



SH5R



SH27

A/Z 0123456789
A/Z-A/Z 0123456789

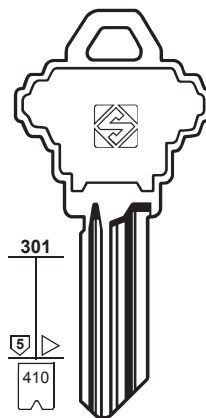

301

5
410



T SH12R

A/Z 0123456789
A/Z-A/Z 0123456789



166

PER / FOR

SCHLAGE (IT) (US)
BALDWIN
TACO

SCHLECHTENDAHL (DE)
CASI
HUTRA
NORDWEST

SCHLEGEL (DE)
DOM (68)

SCHÜCO (DE)
CISA (55)
KFV (116)

SCHULTZ (DE)
EURO LOCKS (78)

S & E (FR)
PICARDIE (155)

SE (FR)
G.R. (99)

SEA (CH)
EZCURRA
HASLER
VIDMAR

PER:
FOR:

SCHLAGE

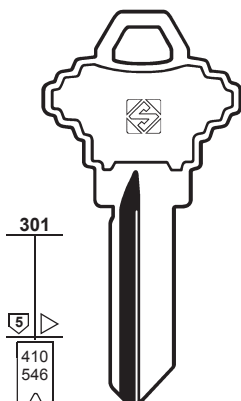

..... 0123456789 C
..... A 0123456789
S 100-27787

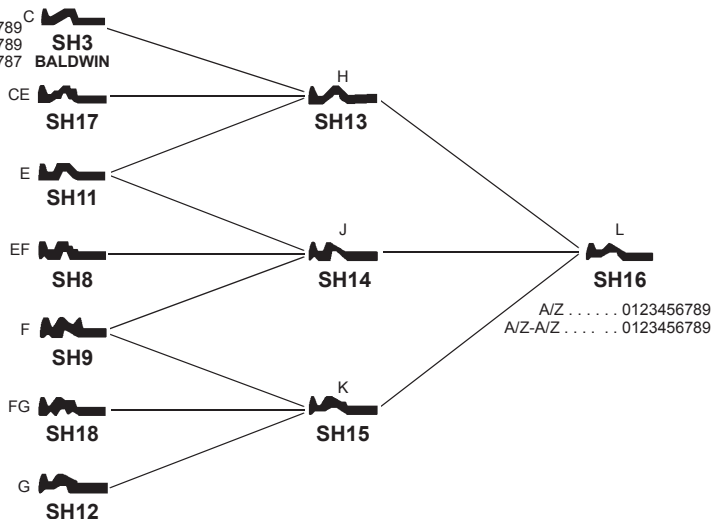

TACO

PER:
FOR:

SCHLAGE

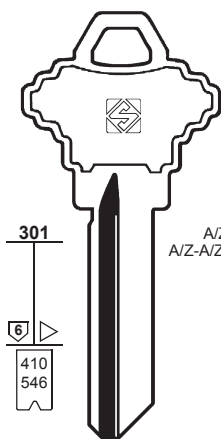

..... DG C
0123456789

A/Z 0123456789
A/Z-A/Z 0123456789

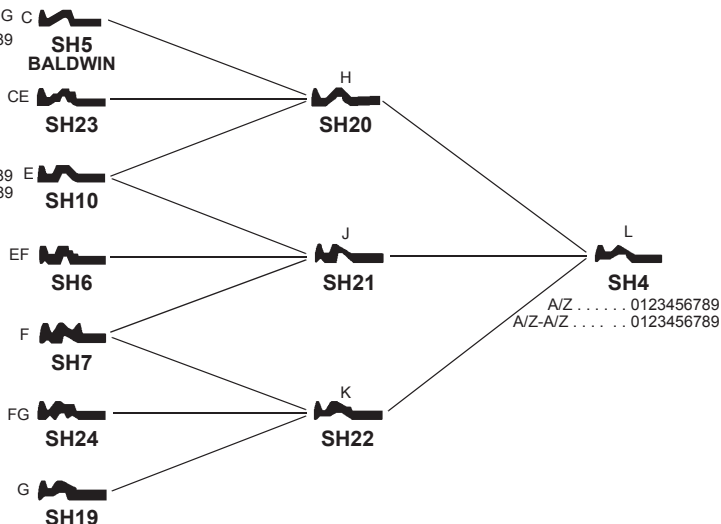

TACO

PER: **SCHLECHTENDAHL**
FOR:

SEA

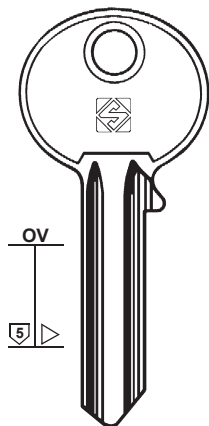

ST1

CASI - HUTRA - NORDWEST

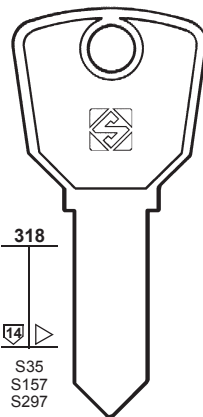

S35
S157
S297

SEB1
20-23



EZCURRA - HASLER

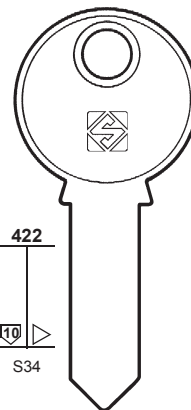

S34

SEB2



EZCURRA - HASLER - VIDMAR

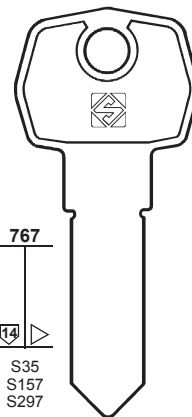

S35
S157
S297

SEB3
20-23



EZCURRA - HASLER - VIDMAR

PER:
FOR:

SEAT

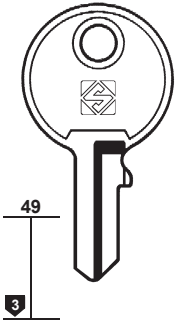

SEA4

SEA4R



MICHEL - SICCAF

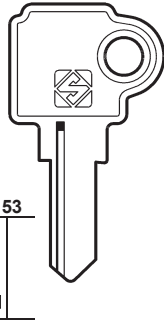

SEA5 SEA5R

SEA7 SEA8



SECURE

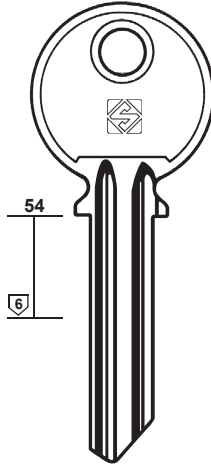

SC1

STA-LOCK

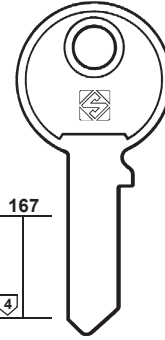

SC2

STA-LOCK



167

PER / FOR

SEAT (IT)
MICHEL
SICCAF

SECURE (GB)
STA-LOCK

SECUREMME (IT)

SECURIT (FR)

SECURITAL (IT)
KYR

+ ABUS (9)
+ FORT (90)

SEEBURG (US)
ILLINOIS (106)

SEGAL (US)
HUDSON
READING

SEIM (FR)
KIFERM (117)

SEKUR (AR)

PER:
FOR:

SECUREMME

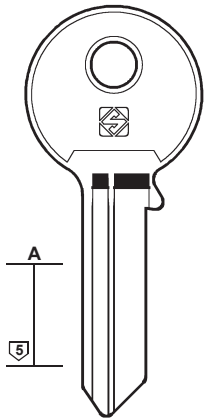

SCM4

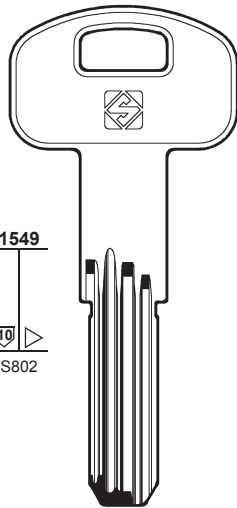

SCM1R
K2

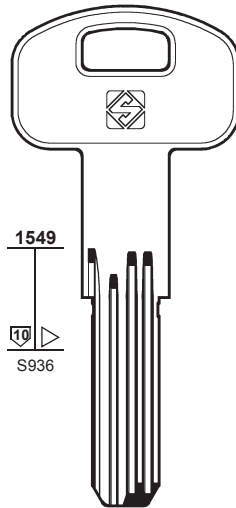

SCM2
K1

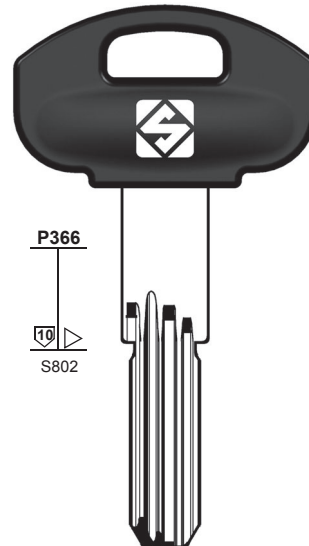

SCM3RP
K2

PER:
FOR:

SECURIT

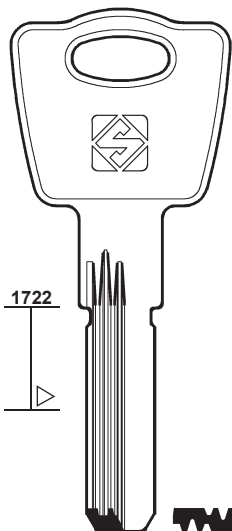

SCT1R



SECURITAL

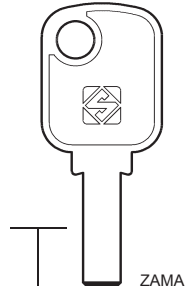

S39
S612
S760
S761
S1265
S1391

SCU1



KYR

SEGAL

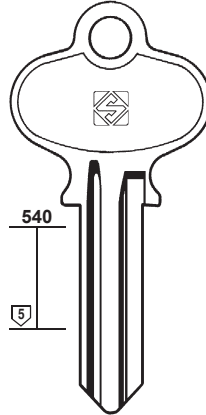

SL1
A
K9

HUDSON - READING

SEKUR

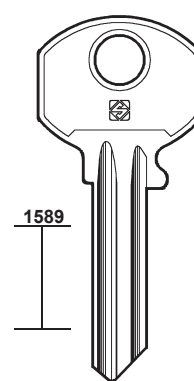

SKR1



168

PER / FOR

SELECT (FR)

SELMACH (RU)

SEMEL (FR)

👁️ JIS (110)

SEN (DE)

👁️ KfV (116)

SERITAL (IT)

👁️ PREFER (157)

SERRALLER (ES)

👁️ AGA (11)

SES (FR)

👁️ MELSMETAL (136)

SESA (FR)

👁️ RONIS (161)

SEZAN (TW)

👁️ YETI (218-219)

SFB (SE)

SHANGHAI (CN)

CINA

+ 👁️ CINA (54)

SHAW (GB)

+ 👁️ HTV (103)

SHILUTE (RU)

SHOWA (JP)

+ 👁️ SARGENT (165)

PER:
FOR:

SELECT

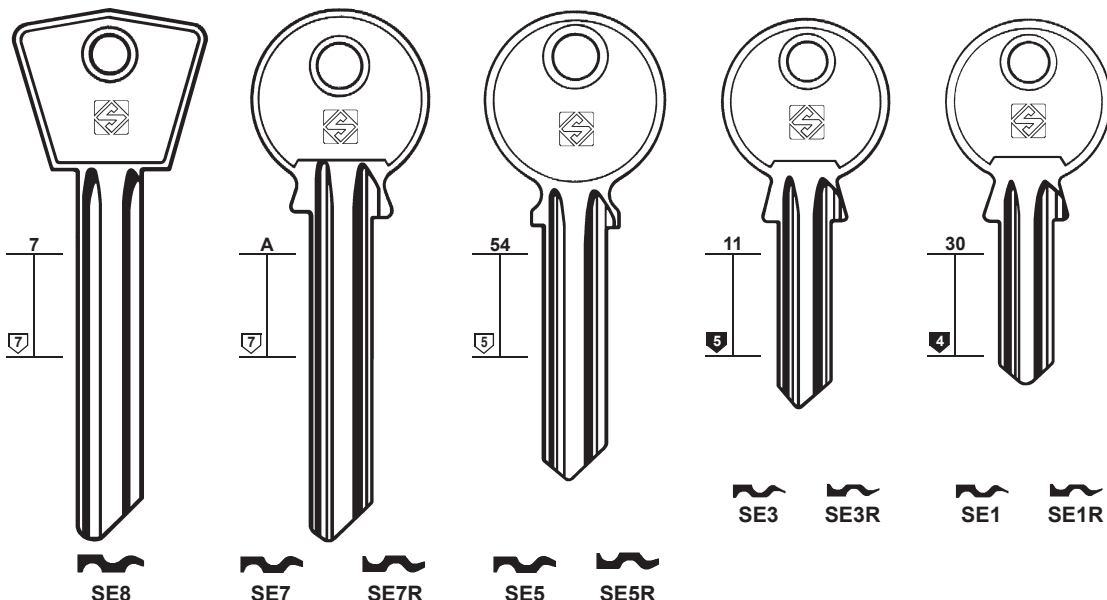

PER:
FOR:

SELMACH

SFB

SHANGHAI

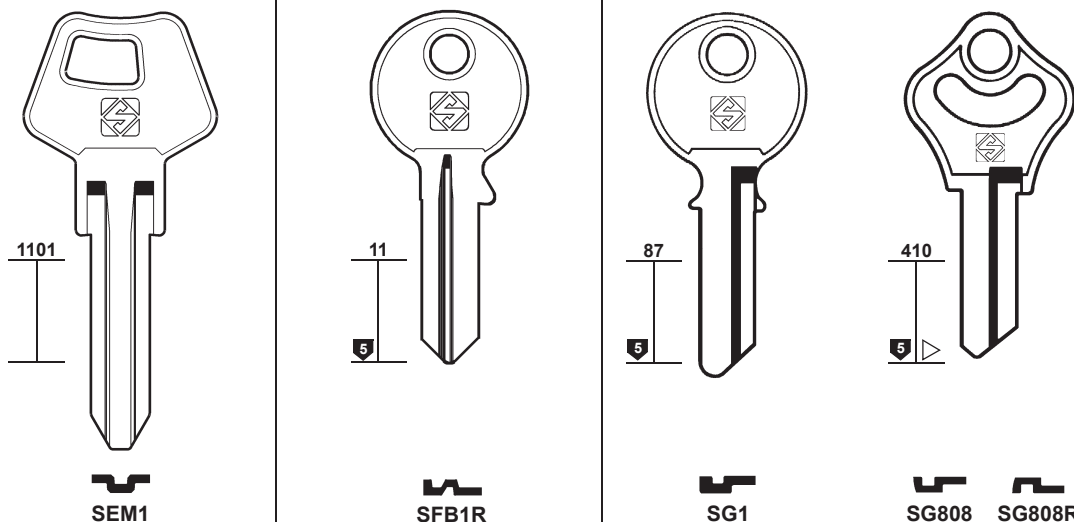







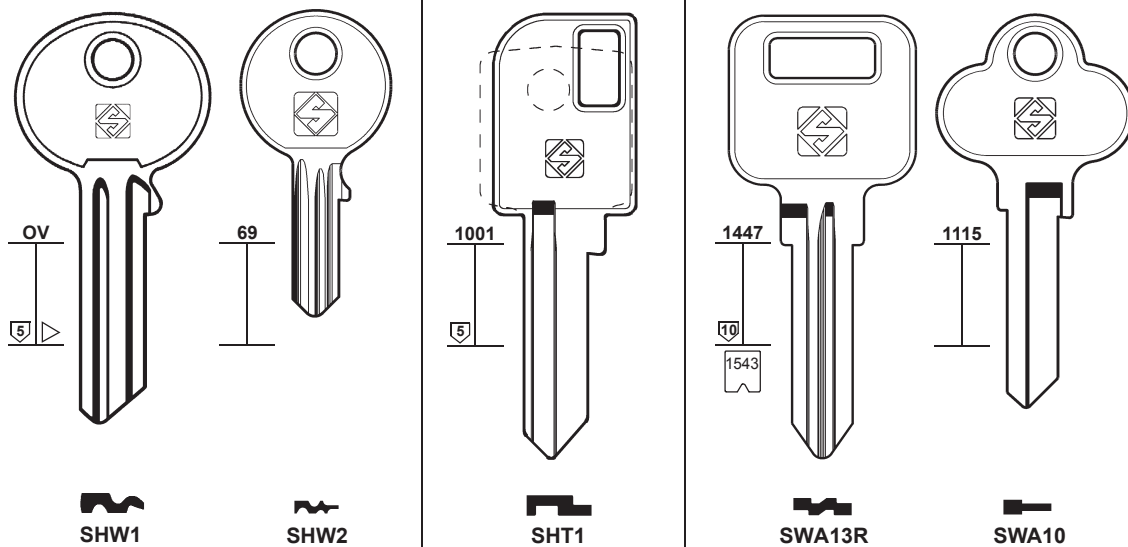

PER:
FOR:

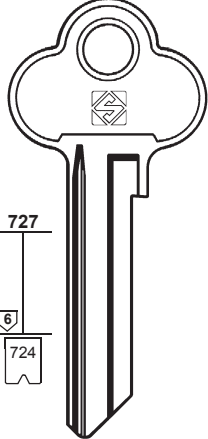
SHAW

SHILUTE

SHOWA

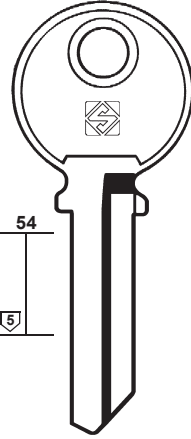
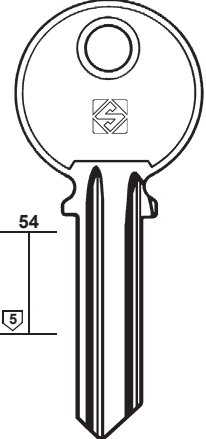

PER: FOR:	SHOWA	SIAM	SIDLEEN
	 <p>SWA2R</p>  <p>SWA3R</p>  <p>SWA4R</p>  <p>SWA5R</p>  <p>SWA6R</p>  <p>SWA1</p>  <p>SWA7R</p>  <p>SWA8</p>  <p>SWA9R</p> <p>1-2-3-4-5-6-7-8-9</p>	 <p>SIA1R</p>	 <p>SD1</p> <p>EXCEL</p>



169

PER / FOR

SHOWA (JP)
+ SARGENT (165)

SIAM (DZ)
+ CITY (58)
+ SIMECA (170)
+ ZENITH (222)

SICCAF (IT)
+ SEAT (167)

SICMA (FR)
+ ZENITH (222)

SIDLEEN (GB)
BANHAM
EXCEL
REGENT
RUFFLER & DEITH
RUFFLER & WALKER

SIEBAU (DE)
+ CES (47)
+ TOK-WINKHAUS (186)

SIGENIA (DE)
+ POS (155)



SIGMA (PL)



SIL (PT)

SILCA (IT)
+ P.C. CORTELLEZZI (154)

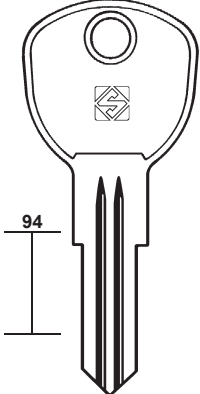
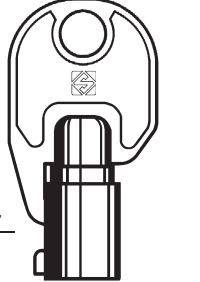
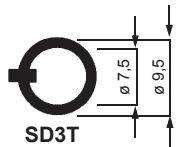
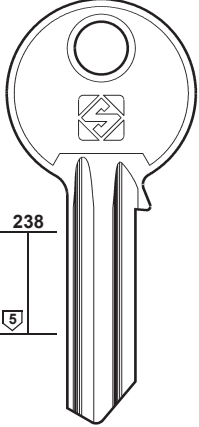
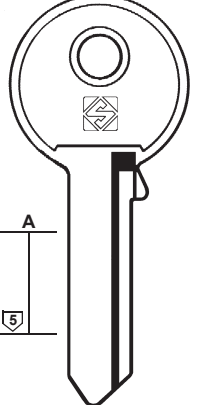
SILVANA (BR)

SIMATIC (CH)
+ SIMECA (170)

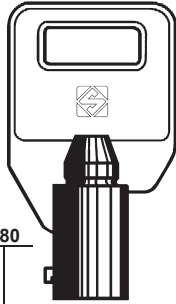
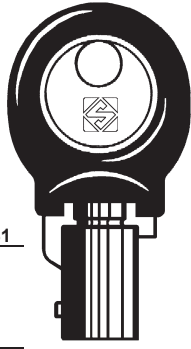
PER: FOR:	SIDLEEN	SIGMA	SIL
	 <p>SD2</p>  <p>SD3T</p>  <p>BANHAM RUFFLER & DEITH RUFFLER & WALKER REGENT</p>	 <p>SGM1</p>	 <p>SIL1</p>  <p>SIL1R</p>

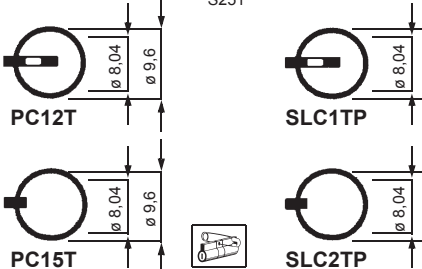
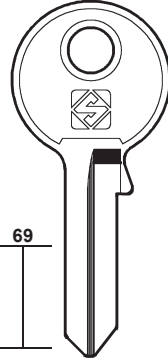
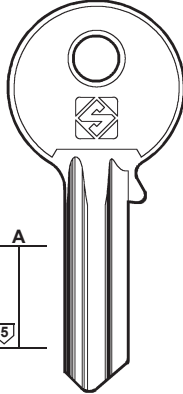
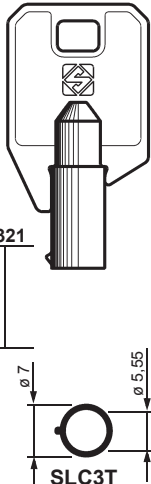
PER: FOR:	SILCA	SILVANA
	 <p>PC12T</p>  <p>SLC1TP</p>  <p>PC15T</p>  <p>SLC2TP</p> 	 <p>SVN1</p>  <p>SVN2</p> 



170

PER / FOR

SIMECA (CH)

CAB
GIUSSANI
GUTLER
JPM
KATE
ORBA
SIAM
SIMATIC

SINA

(IT) ZANI (220)

SINJET

(DE) DOM (68)

SIS

(IT) FEL
LASBOLAGET
PICARDIE
ZENITH

PER:
FOR:

SIMECA

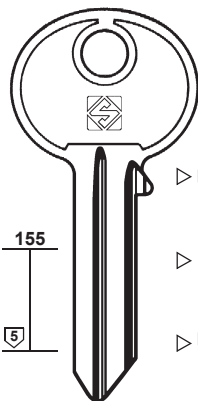

155
5



SM10R SM14R

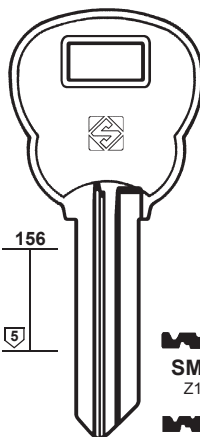

156
5



SM9R SM9 40

GUTLER - KATE
ORBA - SIAM - SIMATIC

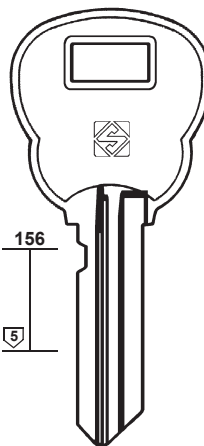

156
5

SM16

JPM

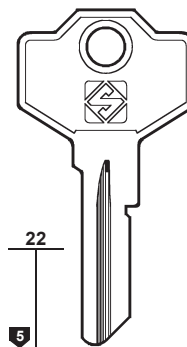

22
5
207



SM1

..... 3001-3480
..... 9001-9741
G 0-480
G 3001-3480
G 9001-9741



CAB
GIUSSANI

PER:
FOR:

SIMECA

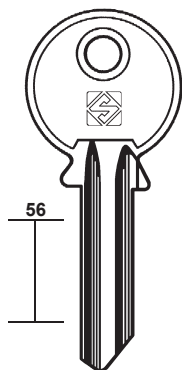

56

SM15

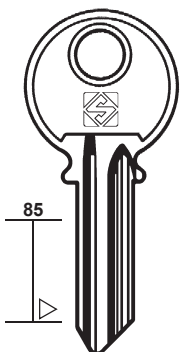

85

SM13

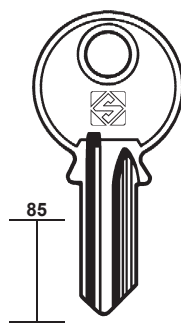

85

SM12

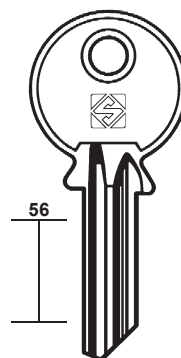

56

SM11

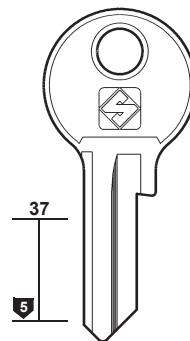

37
5

SS1 SS1R

SS3 SS3R

SS10
UTZ



ZENITH

PER:
FOR:

SIS (IT)

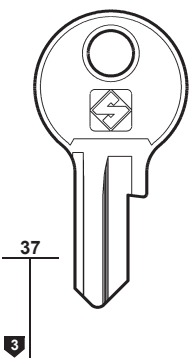

37
3

SS9



FEL

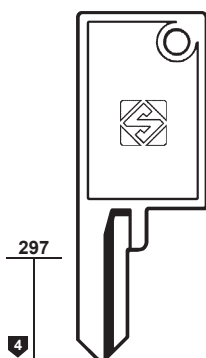

297
4

SS6

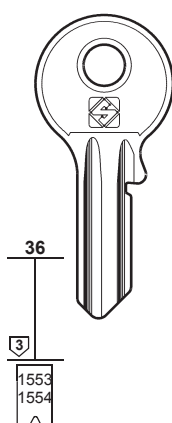

36
3
1553
1554

SS14 SS14R

... 7654321



PICARDIE

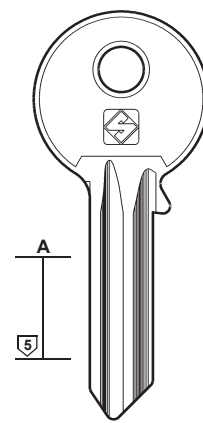

A
5

SS12

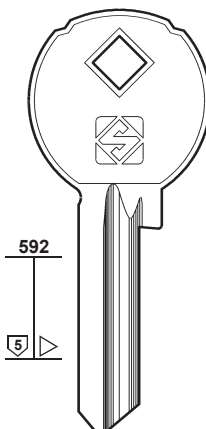

592
5

SS7 SS7R

LASBOLAGET

PER:
FOR:

SIS (IT)

SIS (PT)



171

PER / FOR

SIS (IT)

SIS (PT)

SISO (DK)

- + CAS-CISMA (45)
- + EVERGOOD (80)
- + OJMAR (147)

SJL (RU)

SKILLMAN (US)
+ CORBIN (61)

SKMZ (UA)

SLAYMAKER (US)
+ SARGENT &
GREENLEAF

SOBINCO (BE)
+ CAS-CISMA (45)
+ SOFI-SONAFI (172)

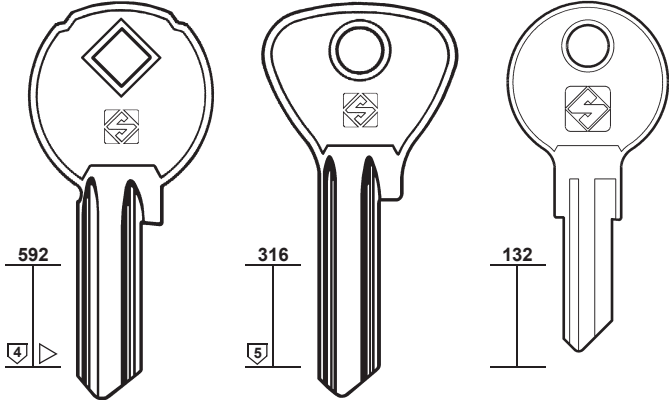

592

316

132

4

5

SS8

SS4

SS13

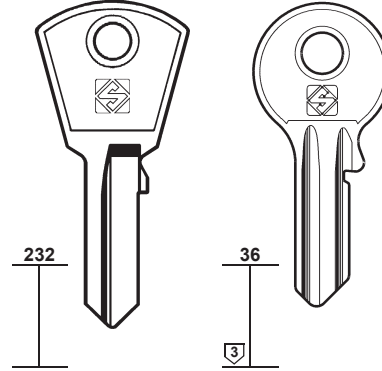

232

36

3

SSP1

SSP5

SSP1R

PER:
FOR:

SIS (PT)

SISO

SJL

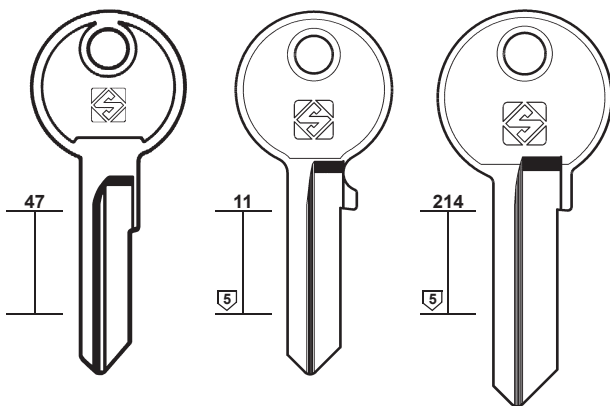

47

11

214

5

5

SSP2

SSP4

SSP4R

SSP6

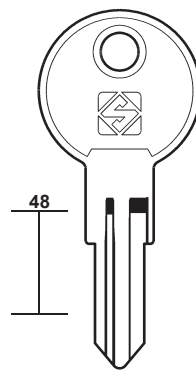

48

SSO1

SSO2

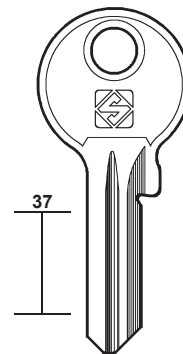

37

SJ1R



PER:
FOR:

SKMZ

SLAYMAKER

SOBINCO

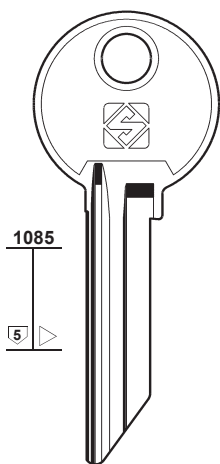

1085

5

CKM1

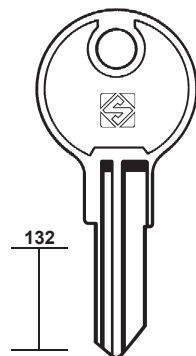

132

SY1

SARGENT & GREENLEAF

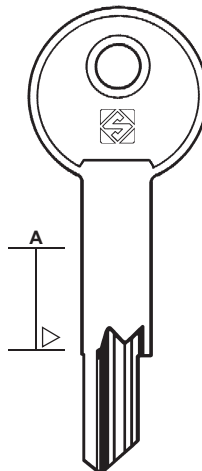

A

SN3R

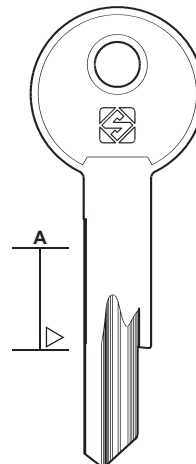

A

SN4R



172

PER / FOR

SOBINCO (BE)
+ **SOFI-SONAFI** (172)

SOF (FR)
 GLOBE (97)

SOFER (PT)

SOFI-SONAFI (PT)
CHAVO
SOBINCO

SOFRANQ (FR)
 RONIS (161)

SOLER (ES)

SOLEX (CN)

SOLID (ZA)
 CES (47)

SOLOR (FR)
 RONIS (161)

SONICO (BG)

PER: FOR:	SOBINCO	SOFER	SOFI-SONAFI
	 1 642 5 2278	 448	 284 5
	 SN1	 SN2	 SN5R
	 SN1R	 SN2R	 SN5R
		 SOF1	 S1
		 SOF1R	 S1R
			CHAVO

PER: FOR:	SOFI-SONAFI				
	 355 5	 355 4	 325 5	 597 4	 317 4
	 SI4	 SI4R	 SI6R	 SI3R	 SI5R
				 SI2R	
					SOBINCO

PER: FOR:	SOLER	SOLEX	SONICO	
	 1308	 1385	 1373 5	 1373 10
	 SLR1	 SLX1	 SNC1	 SNC2
		 SNC2R	 SNC3	

PER:
FOR:

SOPRANO

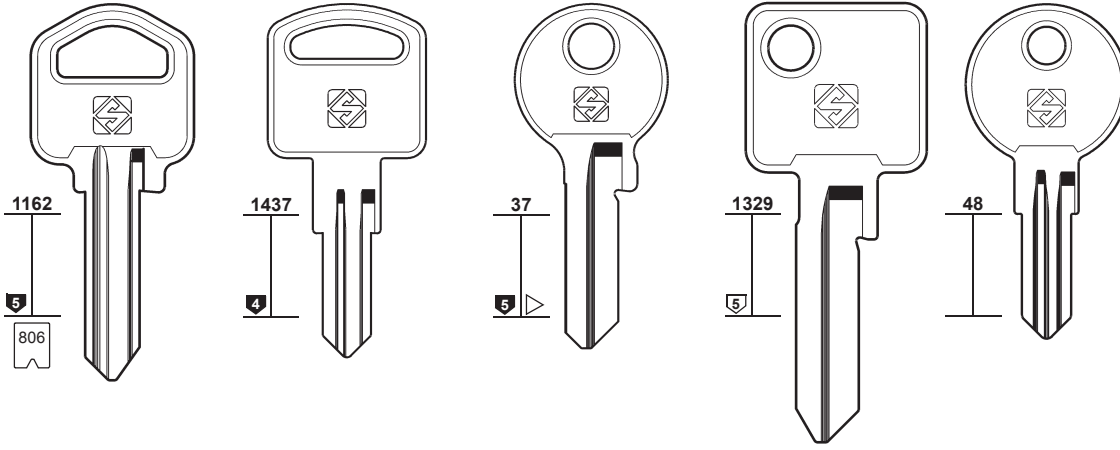

SOP1

1-2-3-4-5-6-7-8-9



SOP2



SOP10



SOP11



SOP12



173

PER / FOR

SOPRANO (BR)

SOS (FR)

- + CITY (58)
- + GABON (93)
- + MING-TAY (140)
- + TESA (181)
- + YALE (215)

PER:
FOR:

SOPRANO

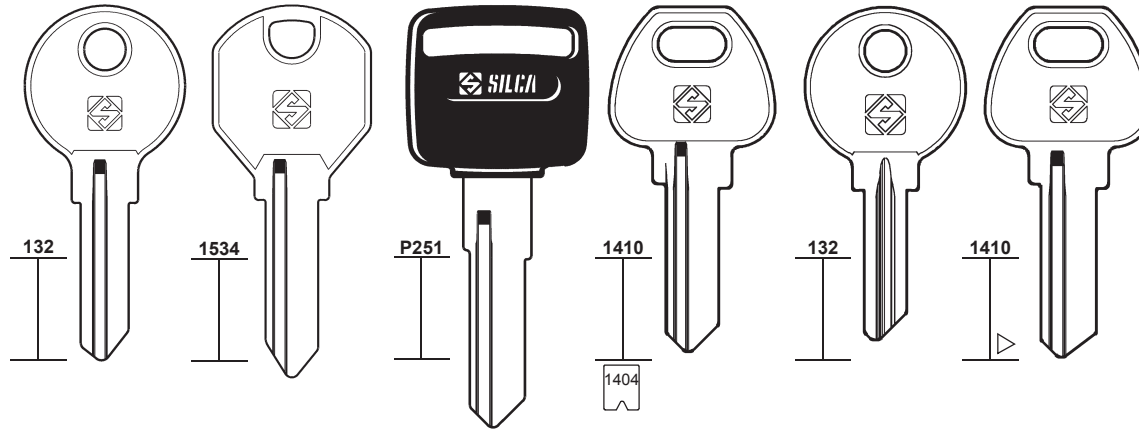

SOP15R



SOP13R



SOP14RP



SOP16R

1-2-3-4-5



SOP17R



SOP18R

PER:
FOR:

SOS

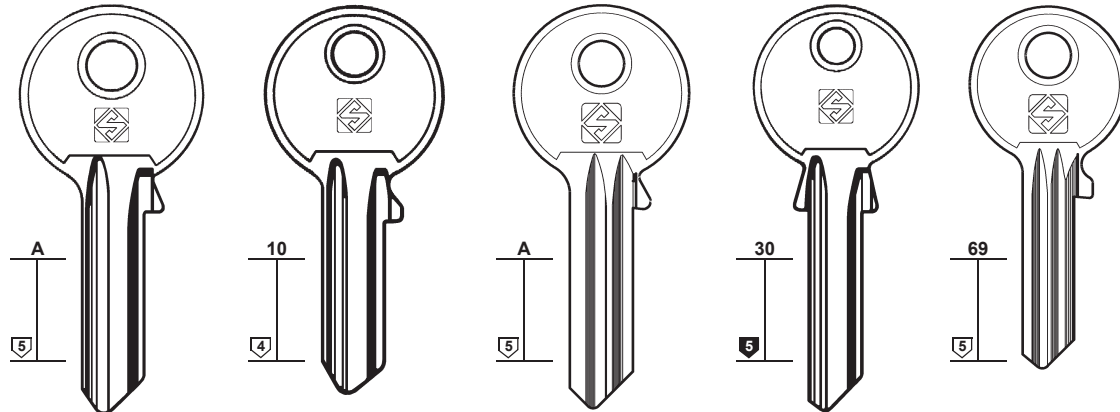

SO4



SO7



SO5



SO8R



SO6



SO9





174

PER / FOR

SOS (FR)

- + CITY (58)
- + GABON (93)
- + MING-TAY (140)
- + TESA (181)
- + YALE (215)

SOUTHCO (GB)

- + YALE (213)

SP (FR)

- + FTH (92)
- + MUL.T.LOCK (144)

SPEEDAL (IT)

- + CES (48)

SPIDER (IL)

- + CAVERS
- + CODKEY

SQUIRE & SONS (GB)

SS (DE)

- + CES (47)

STA-LOCK (GB)

- + SECURE (167)

STAM (BR)

PER:
FOR:

SOS

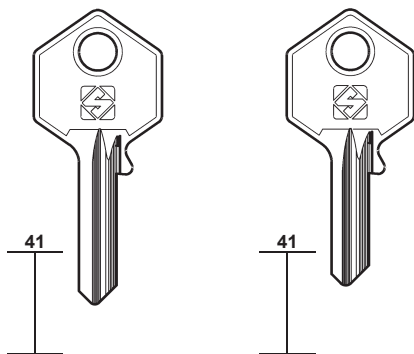

SO10R

SO11R



mm 25

SPIDER

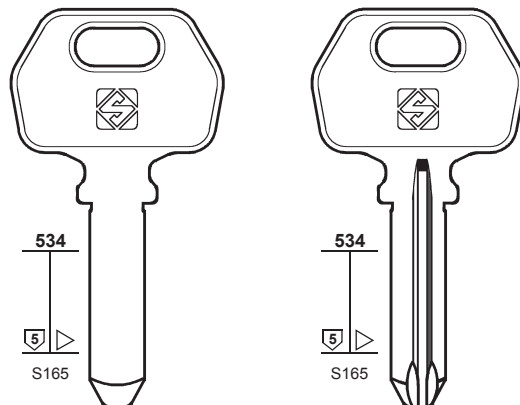

SPR1

SPR2



CODKEY



CAVERS

PER:
FOR:

SQUIRE & SONS

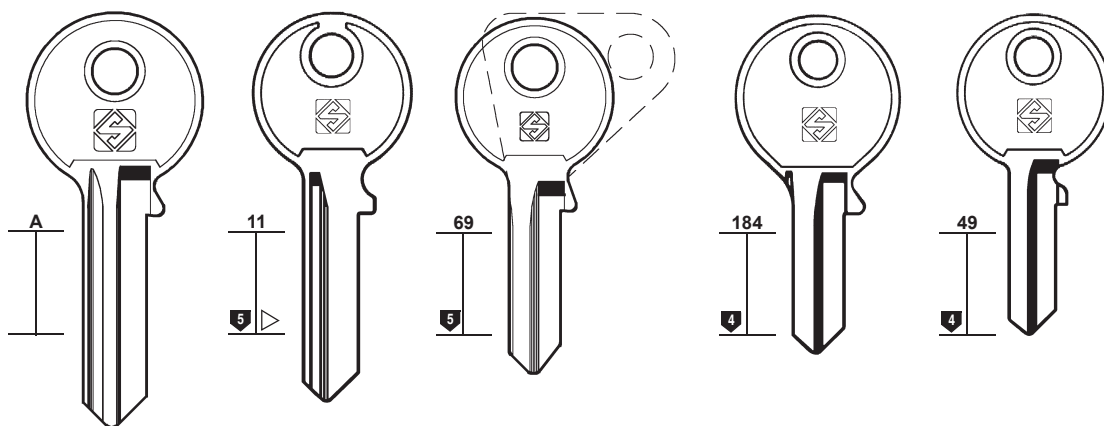

SQ4R

SQ3R

SQ5

SQ1

SQ2



PER:
FOR:

SQUIRE & SONS

STAM

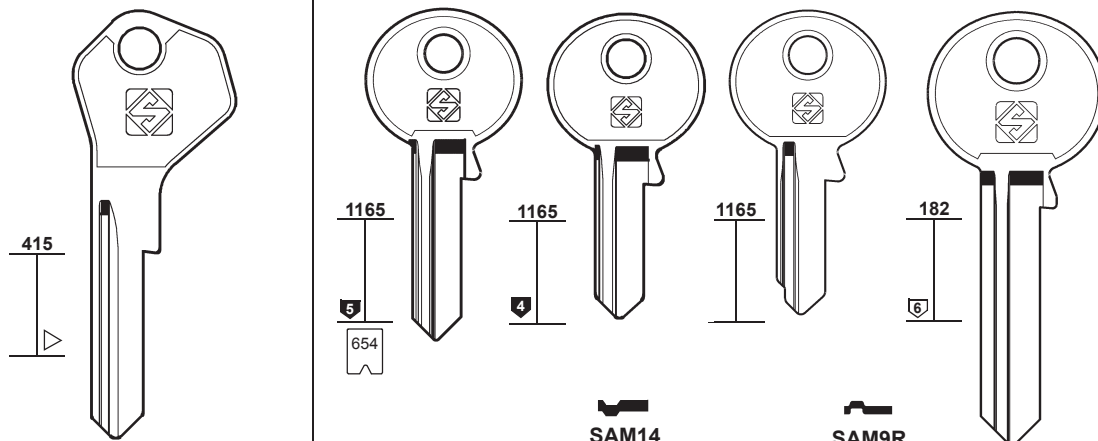

SQ6R

SAM14

SAM9R

SAM1

SAM1R

SAM15R

SAM13

SAM13R

SAM4

..... 1-2-3-4-5-6-7-8

PER:
FOR:

STAM

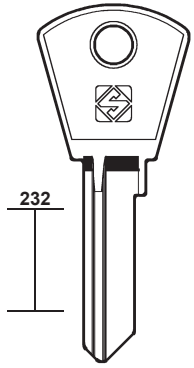

SAM6

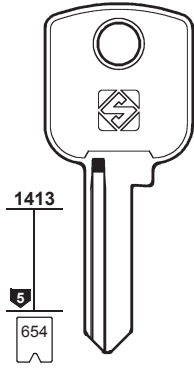

SAM12R

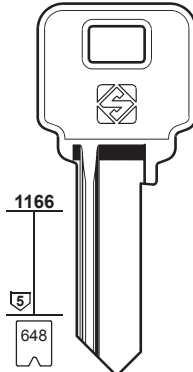

SAM2R

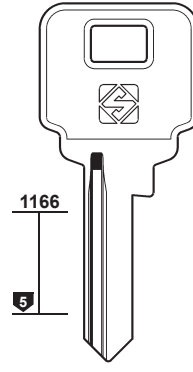

SAM3R



175

PER / FOR

STAM (BR)

STANDARD (DE)

👁️ CISA (55)

STANOFDRO (CN)

STAR (JP)

+ 👁️ ISEO (108)

PER:
FOR:

STAM

STANOFDRO

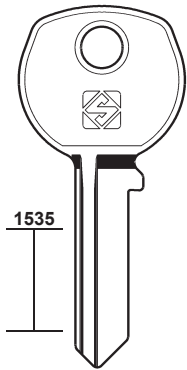

SAM10

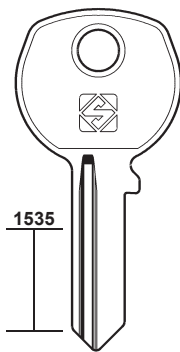

SAM11R

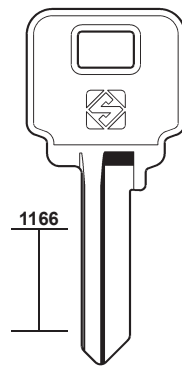

SAM8

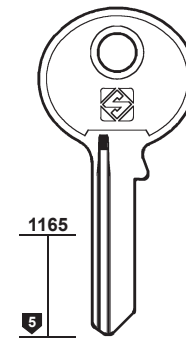

SFD1R

PER:
FOR:

STAR

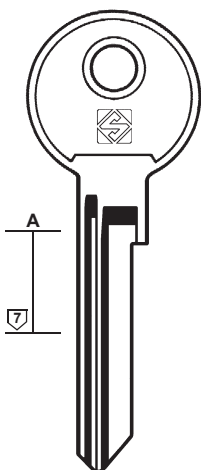

STA2 STA2R

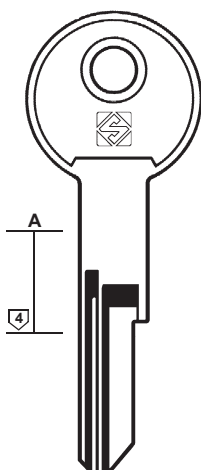

STA1 STA1R

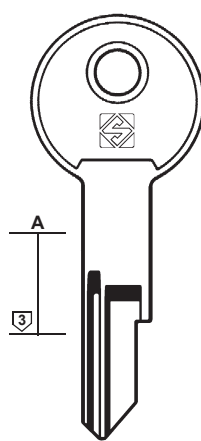

STA3 STA3R

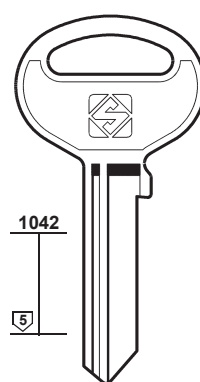

STA10 STA10R

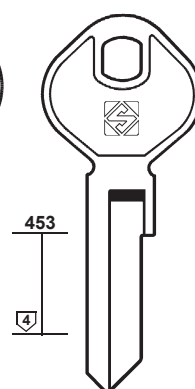

STA9R

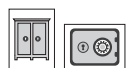



176

PER / FOR

STAR (JP)

GS
IJ
TEC
+ ISEO (108)

STARLET (DE)

GERA

STARRY (NL)

STEELCASE (US)

CHICAGO (52)
HUWIL (104)

STEIGA (DE)

DOM (70)

STEM (FR)

ABUS (9)

STIQAM (TN)

CAS-CISMA (45)

STORWALL (GB)

STRAFOR (GB)

HUWIL (104)
LAS (121)
RONIS (161-162)

STREBOR (GB)

STREMLER (FR)

BRICARD (39)
CAS-CISMA (45)
CORBIN (60)
RONIS (161)

PER:
FOR:

STAR

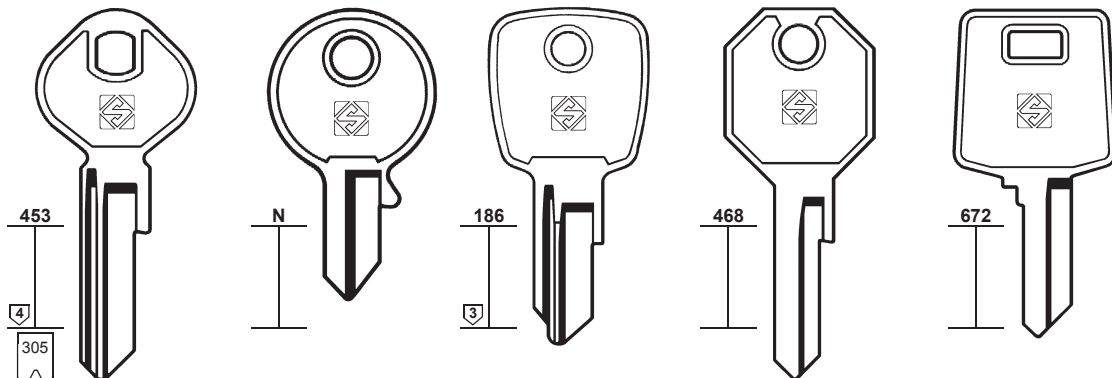

PER:
FOR:

STARLET

STARRY

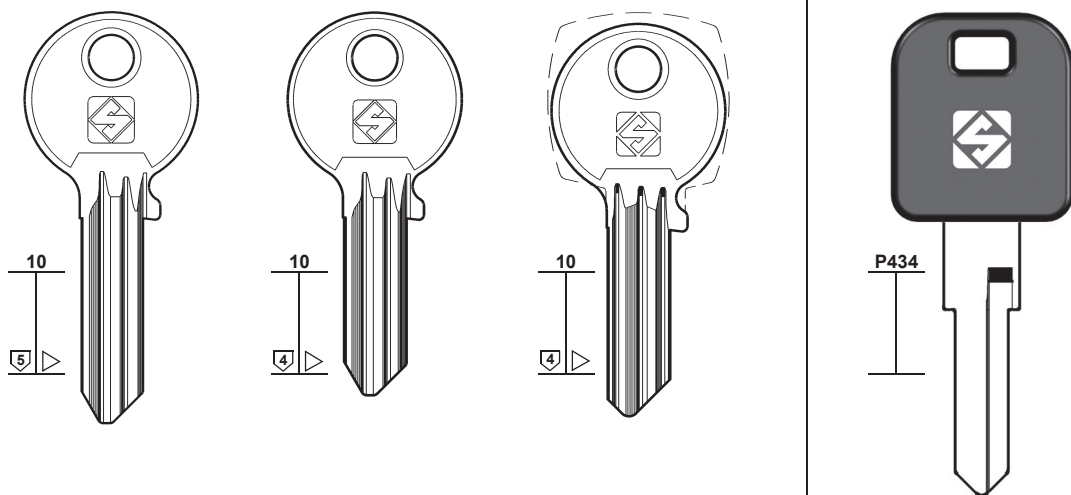

STL1R

STL2R

STL3

STY1P

GERA



PER:
FOR:

STORWALL

STREBOR

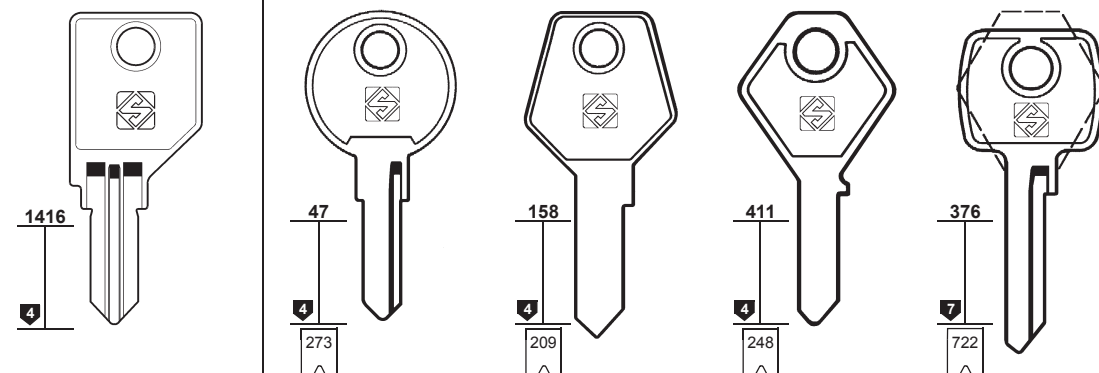

SWL1

STR5
F... 402-480

STR3
S... 1-70

STR4
RR... 502-579

STR6
MT... 1-989

STR5R
F... 503-581

STR4R
RR... 502-579



PER:
FOR:

STS

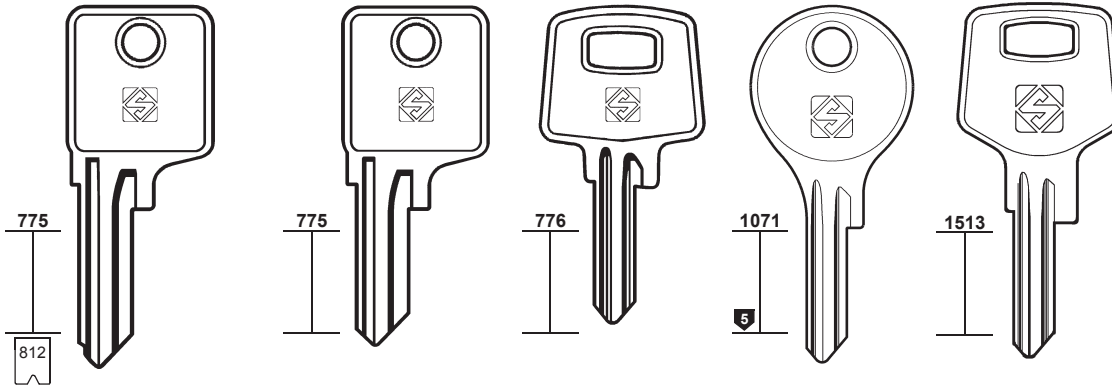

(625) 0-1-2-3-4-5



ALSO



BTV

ARFE



177

PER / FOR

STS (ES)

ALSO

ARFE

BTV

TESA

+ ARFE (19)

+ DOM (68-71)

+ ELCA (76)

+ PICARDIE (155)

+ TESA (181-182)

PER:
FOR:

STS

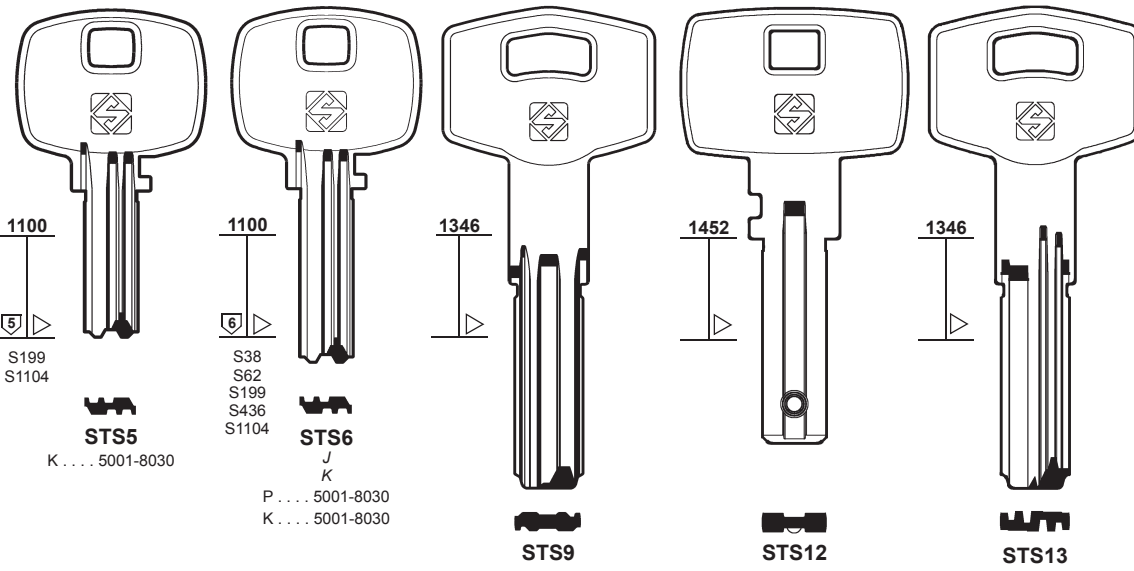

S199
S1104



STS5

K 5001-8030

S38
S62
S199
S436
S1104



STS6

J
K

P 5001-8030

K 5001-8030



STS9



STS12



STS13



TESA

STUBLINA (RS)

STUMPF (DE)

+ OJMAR (147)

STUV (DE)

+ CES (47)

+ DOM (70)

+ GEVY (95)

+ MLM (141)

PER:
FOR:

STUBLINA

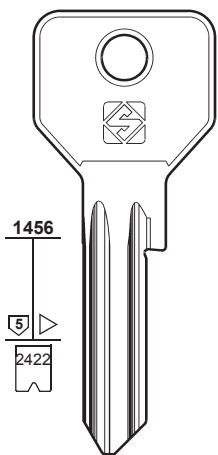

STN1



STN1R

. 12345678

STUMPF

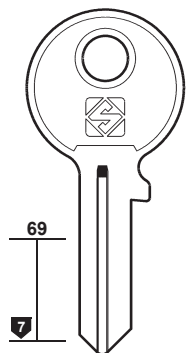

STF1



STF1R

STUV

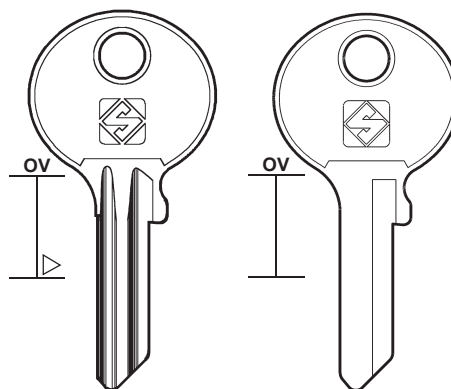

SV3



SV3R



SV7





178

PER / FOR

STUV (DE)

DOM
MLM

- + CES (47)
- + DOM (69)
- + GEVY (95)
- + MLM (141)

STV (IT)

- + OMIV (149)
- + GEVY (95)

SÜDMETALL (DE)

SUF (FR)

- + FTH (91)

SUKI (JP)

- + FLORA (90)

SUL (IT)

- + CORBIN (60)
- + P.C. CORTELLEZZI (153)

SUNSUI (TW)

SUPER (TW)

SUREX (FR)

- ATLAS
- EUROP
- MATTEY
- + GABON (93)
- + YALE (213)

SURFINOR (FR)

- + FICHET (89)

SUYOKA (JP)

- + AGA (11)

SWAN (IT)

- + YETI (218-219)

PER:
FOR:

STUV

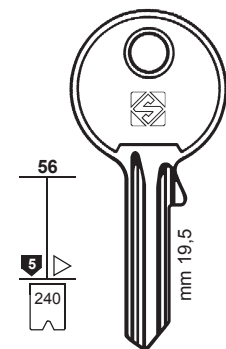

2F ... 201-278 1F ... 201-278
1F ... Z 201-278 1F ... Z 201-278
1F ... X 201-278 1F ... X 201-278



SV2R

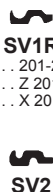

SV2

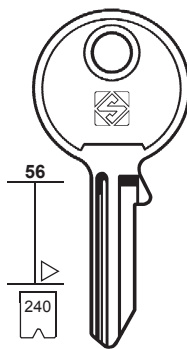

2F ... 201-278 2F ... 201-278
1F ... Z 201-278 1F ... Z 201-278
1F ... X 201-278 1F ... X 201-278



SV4R



SV5R



SV8R

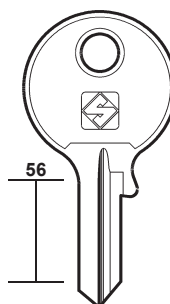

SV6R
1FP

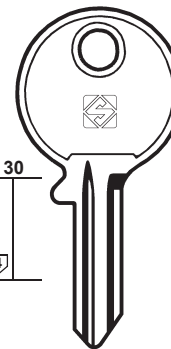

YM18



MLM - DOM



SÜDMETALL

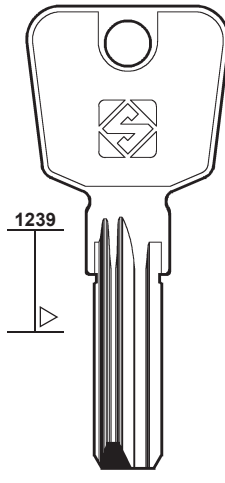

SDT1R



PER:
FOR:

SUNSUI

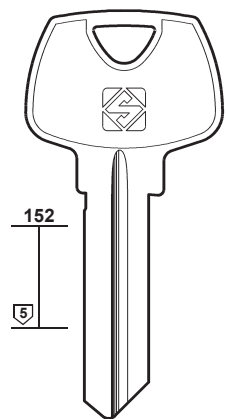

SU1R

SUPER

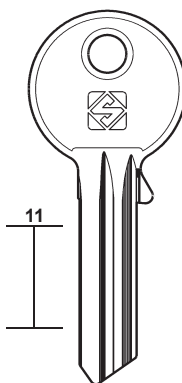

SPU1R

SUREX

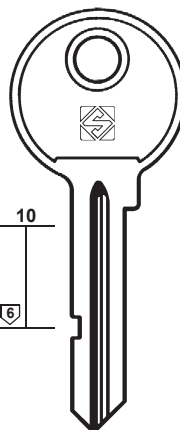

SR8

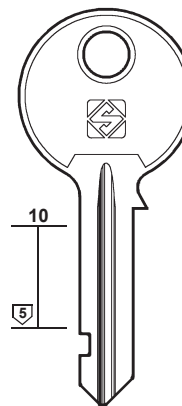

SR7

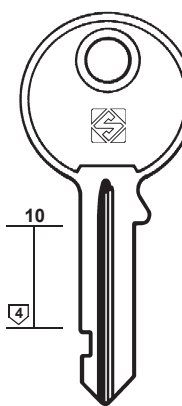

SR6

PER:
FOR:

SUREX

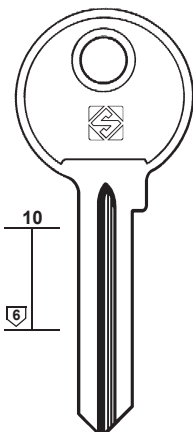

SR10R

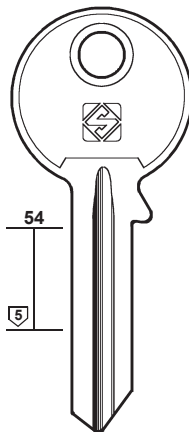

SR4

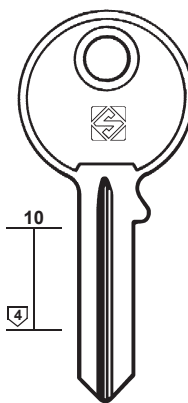

SR11R

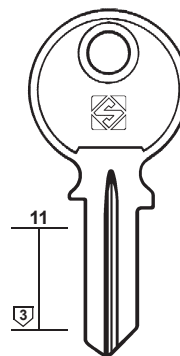

SR2 SR2R

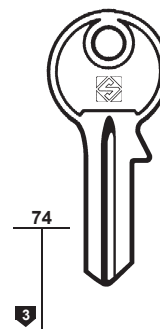

SR9R



ATLAS



ATLAS - EUROP
MATTEY

PER:
FOR: **SWEDA**

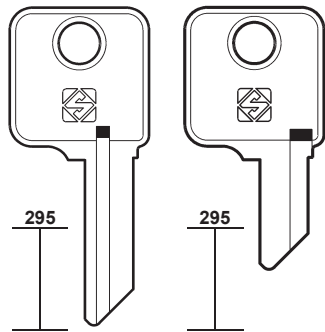

SW1R
Z

SW3
L

SW2
X



TALLIN

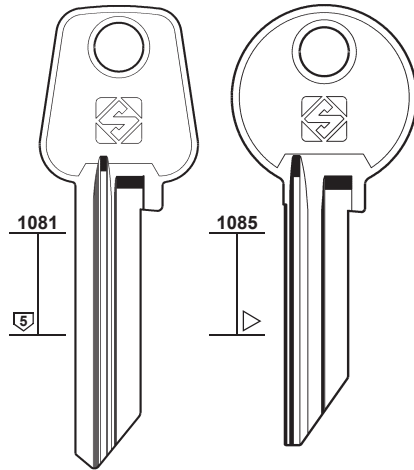

BLT1R

TLN1

TAMPALINI

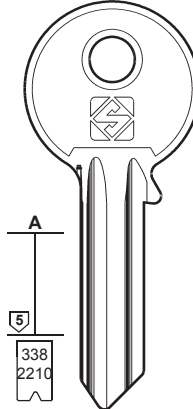

TP1 **TP1R**
..... 123456
..... 12345

BALLY - K+K - SAB - TF



179

PER / FOR

SWEDA (IT)
+ **PREFER (157)**
+ **PRIM (158)**

SWISSTAC (DE)
 DOM (68)

T-KEY (CN)
 BALING LOCKS (30)

TACO (USA)
 SCHLAGE (166)

TALLIN (EE)

TAMPALINI (IT)
BALLY
K+K
SAB
TF
+ **MORI E. (142)**

TANLOCKS (ZA)
 LÄSBOLAGET (122)

TARONI (IT)

PER:
FOR: **TAMPALINI**

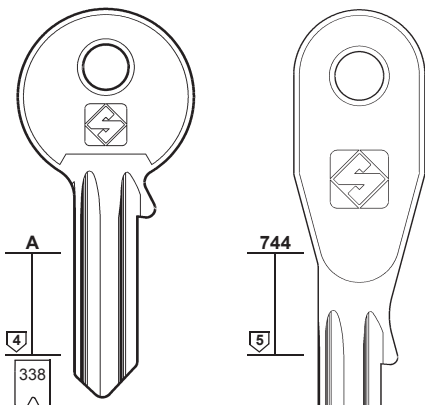

TP2 **TP2R**
..... 1-2-3-4-5-6

TP3

TP3R

TARONI

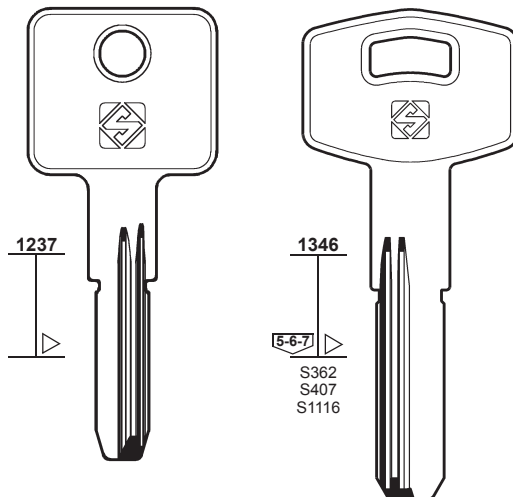

TAR21

TAR16 **TAR16R**



PER:
FOR: **TARONI**

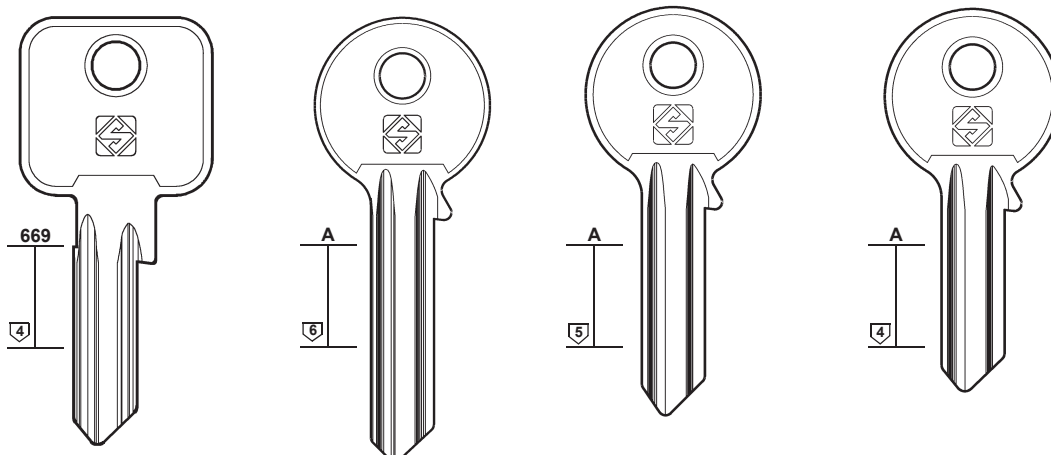

TAR26

TAR11

TAR4

TAR5

TAR9

TAR11R

TAR4R

TAR5R

TAR9R



180

PER / FOR

TARONI (IT)

TARZEN (TW)

TAS (DE)
BIBERING
TÜRSCHLOSS

TAUB (ES)
ZANETTI A. (220)

TAV (FR)
RONIS (162)

TAYLOR (US)

TEC (FR)
STAR (176)

TECON (ES)

TECHNAL (DE)
CAS-CISMA (45)
TESA (181)

TECNOR (FR)
FICHET (89)

TECSESA (ES)

TEEN HAAF (NL)
KIFERM (117)

PER:
FOR:

TARONI

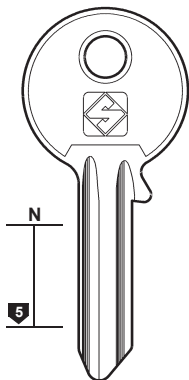

TAR8R

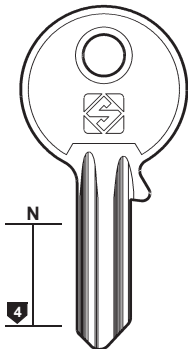

TAR3R

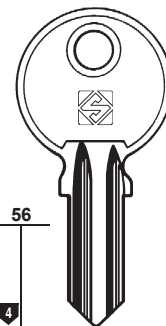

TAR6R

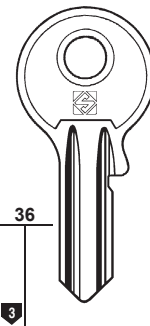

TAR10R



PER:
FOR:

TARONI

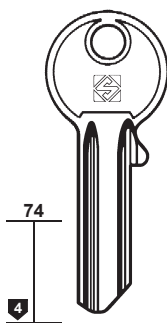

TAR1R

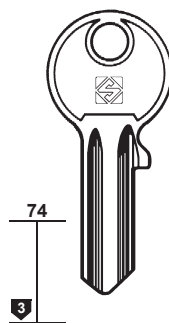

TAR2R



TAR7R



TARZEN

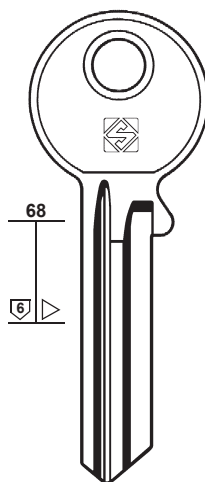

TZN1

TAS

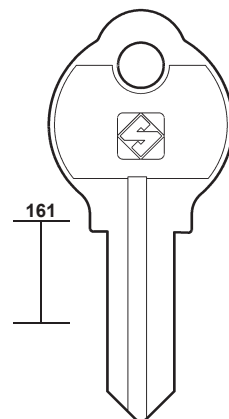

TUS1



TUS1R



TUS2R

BIBERING - TÜRSCHLOSS

PER:
FOR:

TAYLOR

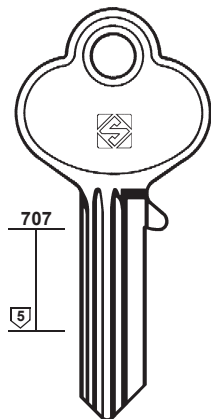

TY1

TECON

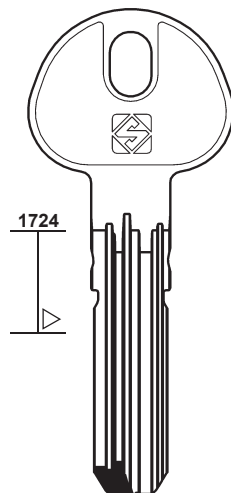

TEN1

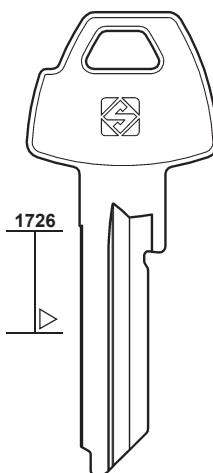

TEN2R

TECSESA

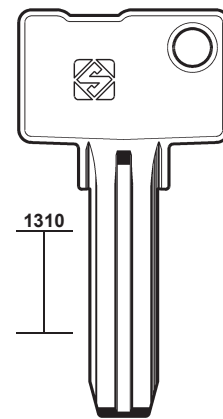

TEC1



PER:
FOR:

TEGASI

TEICOCIL

TEKA

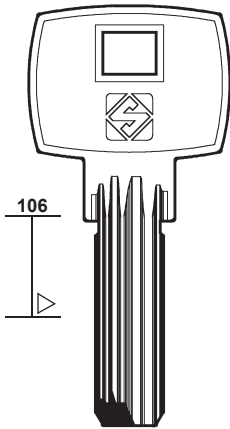

TGS1R

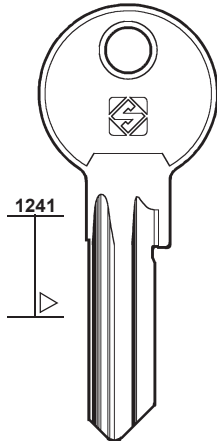

TCL1

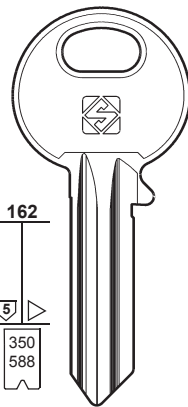

ASS6

20201
..... 0-1-2-3-4-5-6-7-8-9-A-B-C
..... D-0-1-2-3-4-5-6-7-8-9-A-B-C

ASSA

ASS6R

20301
..... 0-1-2-3-4-5-6-7-8-9-A-B-C
..... D-0-1-2-3-4-5-6-7-8-9-A-B-C

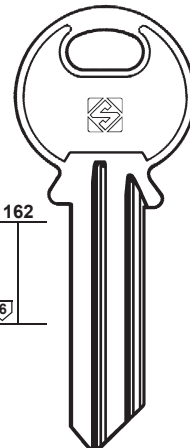

TK3

20902

TK3R

20802

ERICSSON

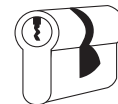

181

PER / FOR

TEGASI (GR)

TEICOCIL (PT)

TEKA (SE)

ASSA
ERICSSON
ERMEX
LM

+ ASSA (21)

TELFORD (GB)

L & F (128)

TEM (ES)

IFAM (106)

TERCA (ES)

AGA (11)

TESA (ES)

ESAFE
GAINSBOROUGH
KAWE
METALUX
NINO
SOS
STS
TECHNAL
+ ELCA (76)

PER:
FOR:

TEKA

TESA

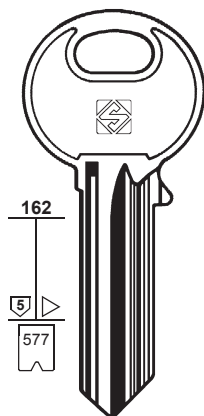

ASSA
ERMEX
LM
TK1
20004
.....
0123456789ABCEFG

TK1R
20102
ASSA
ERMEX
LM

TK4
21701

TK2
21001

TK4R
21601

TK2R
21101

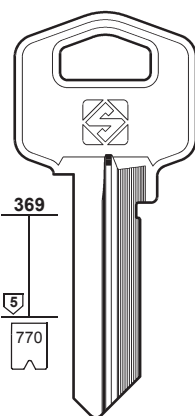

TE1
TE1R
..... (TE-5)
0-9-8-7-6-5-4-3-2-1

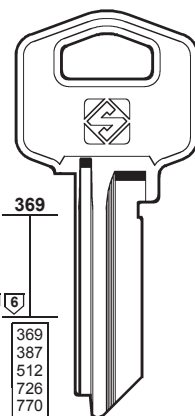

TE2 ESAFE
..... (TE-5) 0987654321 123456789
..... 0123456789 A/Z 123456789
..... 123456789
..... A/Z 123456789

GAINSBOROUGH - KAWE
METALUX - NINO - SOS - TECHNAL

TE3
..... 123456789
..... A/Z 123456789

TE6
..... 0987654321

PER:
FOR:

TESA

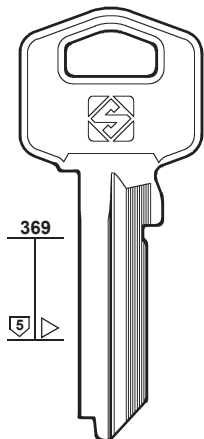

TE2X

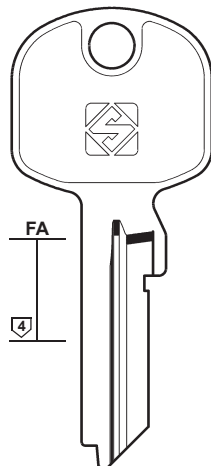

TE8XFA

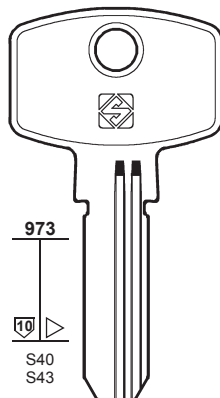

TE4
TE4R
T-10

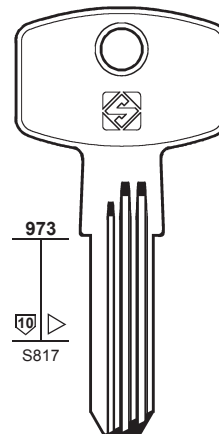

TE16
T-10P



STS





182

PER / FOR

TESA (ES)

KALE
STS
VIRO
+ ELCA (76)

TESIO (IT)

CORBIN (61)

TESTA (IT)

CAS-CISMA (45)

TF (IT)

TAMPALINI (179)

TH (DE)

H.R.S.
TRUMPF

THIRARD (FR)

THÖMEE (DE)

CES (50-51)

THÖNE (DE)

CORBIN (60)

TICINO (IT)

BERTOLOTTI

TIEFENTHAL (DE)

CISA (55)
 ELZETT (76)
 EMR (77)
 GTV (100)
 JOWIL (110)

TIFON (TW)

TIGRIS (GB)

TIK (GB)

TILANCO (IT)

PER:
FOR:

TESA

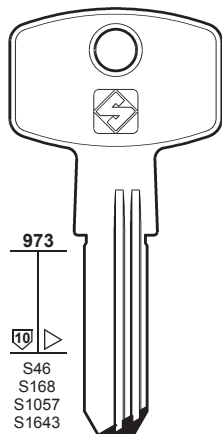

EC5



KALE - STS - VIRO

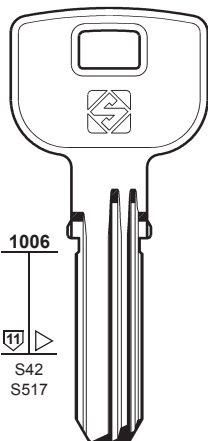

TE5

T-80



TE9

T80/SC



STS

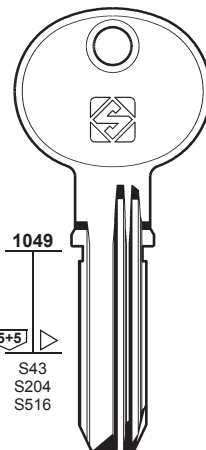

TE7

T-60



STS

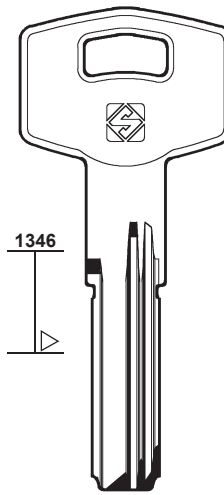

TE19



STS

PER:
FOR:

TH

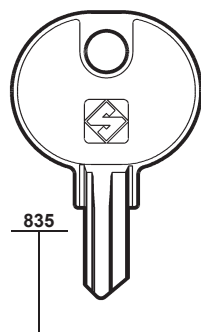

THA1

H.R.S. - TRUMPF

THIRARD

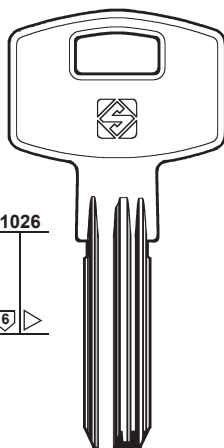

THR1



TICINO

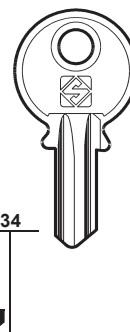

TC1



TC1R



BERTOLOTTI

TIFON

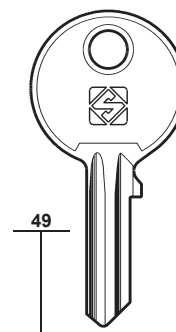

TFN1



TFN2

PER:
FOR:

TIGRIS

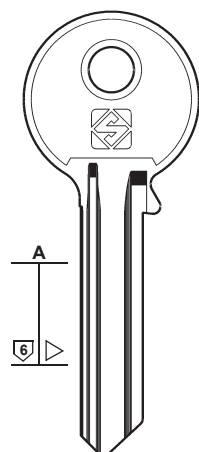

TG1

TIK

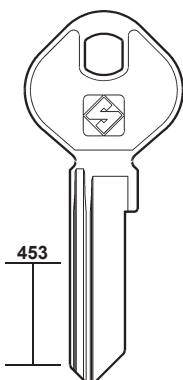

TI1

TILANCO

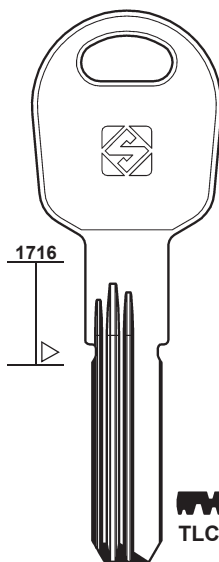

TLC1R



TITAN

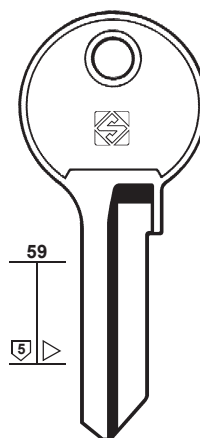

TN1



TN1R

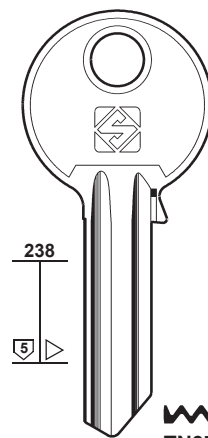

TN2



TN2R



TN5



TN8R



TN37R

PER:
FOR:

TITAN

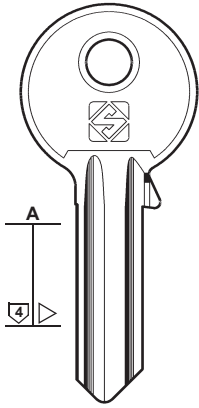

TN16

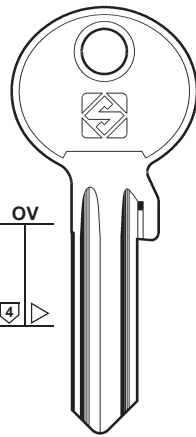

TN16X

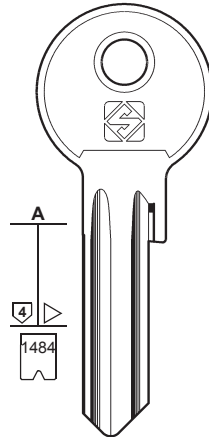

TN16XA TN39

... 123456789

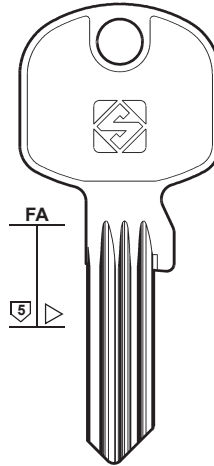

TN19R TN23

PICARDIE



183

PER / FOR

TITAN (SI)
EMKA
FTH
GIUSSANI
LAMA
PICARDIE
VACHETTE

TITAN LOCK (US)
KWIKSET

PER:
FOR:

TITAN

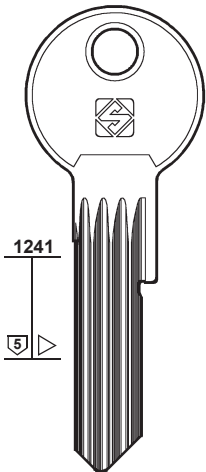

TN50

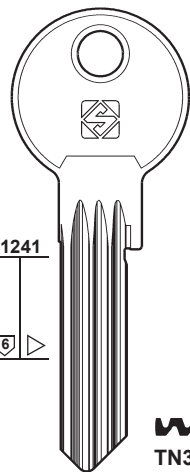

TN20



TN31R
T100

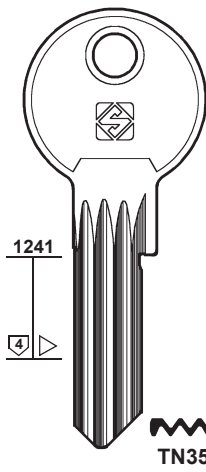

TN36



TN35

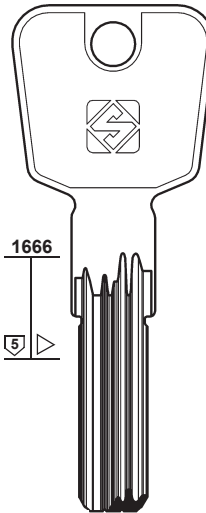

TN51

TN32

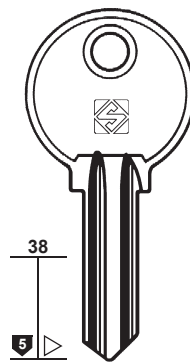

TN7
EMKA
GIUSSANI

TN4

TN4R
GIUSSANI



PER:
FOR:

TITAN

TITAN LOCK

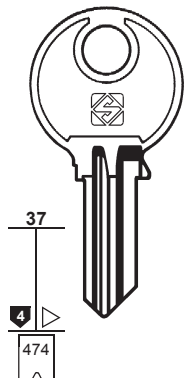

TN9
... 251-300

TN10

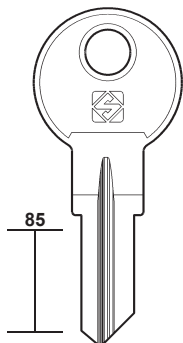

TN6R

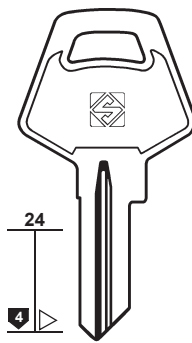

TN11R

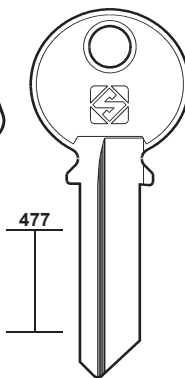

TN14

FTH
VACHETTE

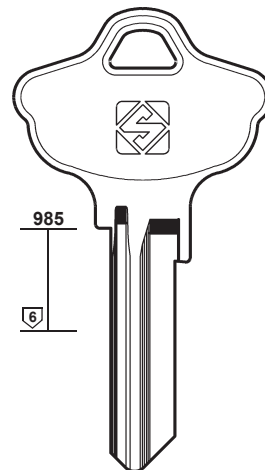

TTL1

KWIKSET



184

PER / FOR

TITAN LOCK (US)
KWIKSET

TITUS (GB)
W.M.S. (211)

TM (DE)
DOM (68)

TOKOZ (CZ)
HOPPE (103)

TOK-TRELOCK (DE)

TOK-WINKHAUS (DE)
MASTER

PER: **TITAN LOCK**

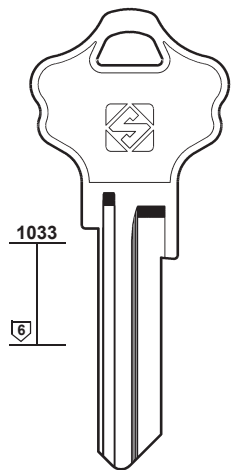

1033



TTL2

KWIKSET

FOR: **TOKOZ**

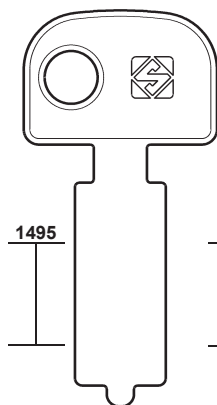

1495

TO22

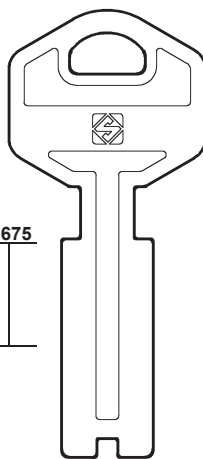

1675

TO26

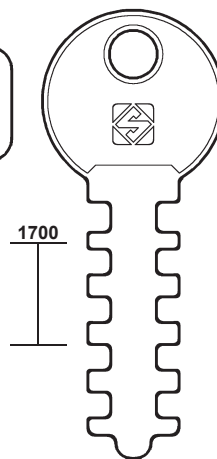

1700

TOZ13

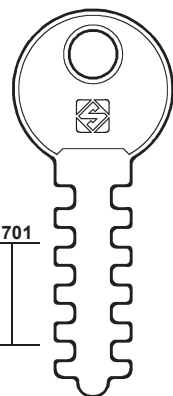

1701

TOZ14



PER:
FOR:

TOK-TRELOCK

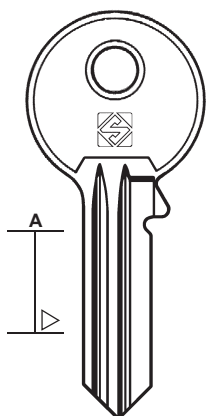

A

TO26
W

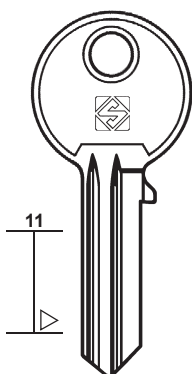

11

TO23
W

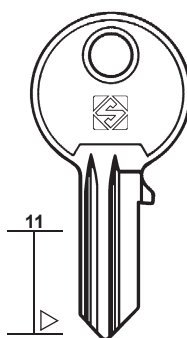

11

TO24
W

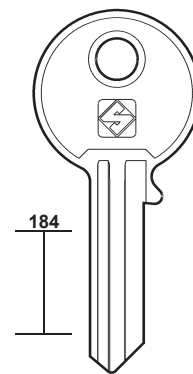

184

TO44

PER:
FOR:

TOK-TRELOCK

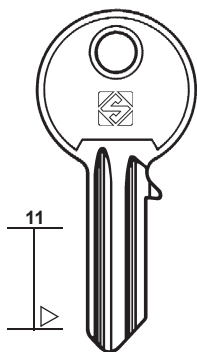

11

TO22

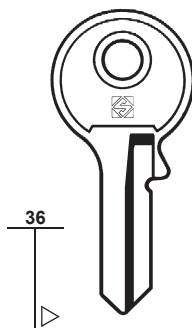

36

TO12



FOR: **TOK-WINKHAUS**

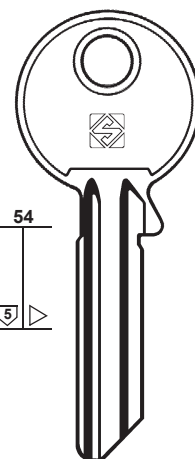

54

TO29

TO92R

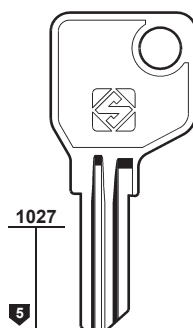

1027

TO66



MASTER

PER:
FOR:

TOK-WINKHAUS

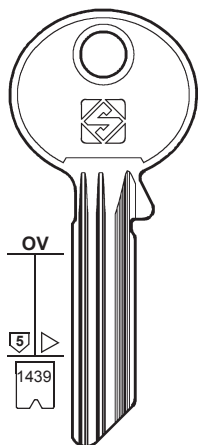

X.....
0-1-2-3-4-5-6

	TO8X1	TO8RX1	TO8X7	TO8RX7	TO8X13 DISQUIN	TO8RX13
	TO8X2	TO8RX2	TO8X8	TO8RX8	TO8X14	TO8RX14
	TO8X3	TO8RX3	TO8X9	TO8RX9	TO8X15	TO8RX15
	TO8X4	TO8RX4	TO8X10	TO8RX10	TO8X16	TO8RX16
	TO8X5	TO8RX5	TO8X11	TO8RX11	TO8X17	TO8RX17
	TO8X6	TO8RX6	TO8X12	TO8RX12	TO8X18	TO8RX18

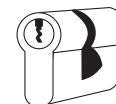

185

PER / FOR

TOK-WINKHAUS (DE)
DISQUIN

PER:
FOR:

TOK-WINKHAUS

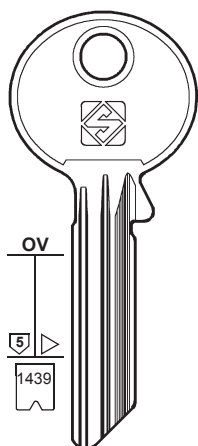

Y.....
0-1-2-3-4-5-6

	TO9Y1	TO9RY1	TO9Y7	TO9RY7	TO9Y13	TO9RY13
	TO9Y2	TO9RY2	TO9Y8	TO9RY8	TO9Y14	TO9RY14
	TO9Y3	TO9RY3	TO9Y9	TO9RY9	TO9Y15	TO9RY15
	TO9Y4	TO9RY4	TO9Y10	TO9RY10	TO9Y16	TO9RY16
	TO9Y5	TO9RY5	TO9Y11	TO9RY11	TO9Y17	TO9RY17
	TO9Y6	TO9RY6	TO9Y12	TO9RY12	TO9Y18	TO9RY18

PER:
FOR:

TOK-WINKHAUS

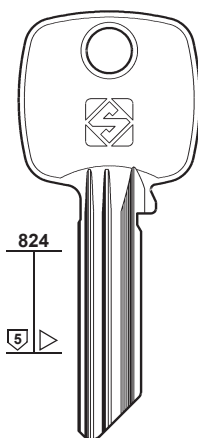

	TO50X1	TO50RX1	TO50X7	TO50RX7	TO50X13	TO50RX13
	TO50X2	TO50RX2	TO50X8	TO50RX8	TO50X14	TO50RX14
	TO50X3	TO50RX3	TO50X9	TO50RX9	TO50X15	TO50RX15
	TO50X4	TO50RX4	TO50X10	TO50RX10	TO50X16	TO50RX16
	TO50X5	TO50RX5	TO50X11	TO50RX11	TO50X17	TO50RX17
	TO50X6	TO50RX6	TO50X12	TO50RX12	TO50X18	TO50RX18



186

PER / FOR

TOK-WINKHAUS (DE)
COMBA
EGSA
SIEBAU
TRELOCK
VACHETTE

PER:
FOR:

TOK-WINKHAUS

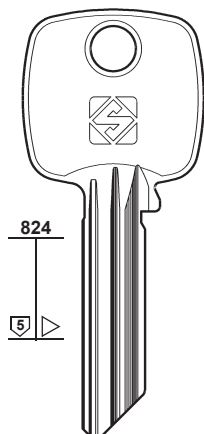

TO51Y1	TO51RY1	TO51Y7	TO51RY7	TO51Y13	TO51RY13
TO51Y2	TO51RY2	TO51Y8	TO51RY8	TO51Y14	TO51RY14
TO51Y3	TO51RY3	TO51Y9	TO51RY9	TO51Y15	TO51RY15
TO51Y4	TO51RY4	TO51Y10	TO51RY10	TO51Y16	TO51RY16
TO51Y5	TO51RY5	TO51Y11	TO51RY11	TO51Y17	TO51RY17
TO51Y6	TO51RY6	TO51Y12	TO51RY12	TO51Y18	TO51RY18

PER:
FOR:

TOK-WINKHAUS

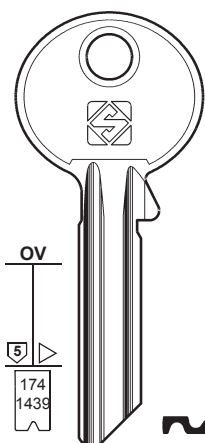

N/T/9
012345678
N 0123456
..... 9 012345678

COMBA - SIEBAU
TRELOCK - VACHETTE

TO54-1	TO54-2	TO54-3	TO54-4
TO54-5	TO54-6	TO54-7	TO54-8
TO6 9	TO5 Z 0123456	TO3 11	TO4 12
TO54-13	TO54-14	TO7 15	TO54-16
TO54-17	TO54-18	TO54-19	TO54-20
TO1	TO54-21	TO2 22	TO54-23
TO15	TO16	TO17 EGSA	TO75R
TO25R	TO28R	TO31R	TO82R

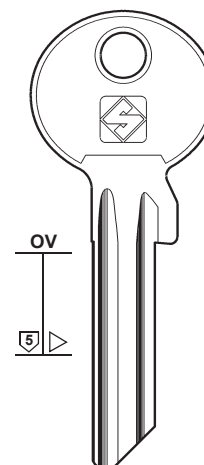

TO1X TO29X

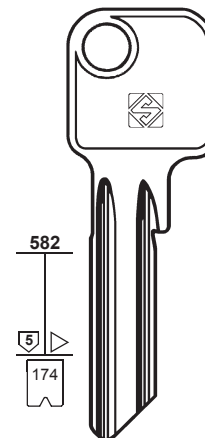

TO10
P
0-1-2-3-4-5-6-7-8
TRELOCK

PER:
FOR:

TOK-WINKHAUS

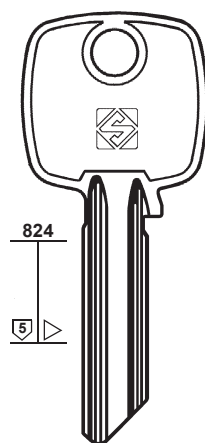

TO35

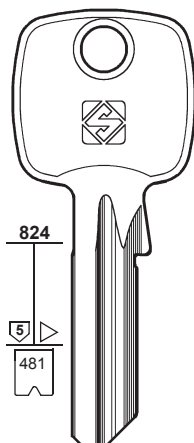

TO36R
TO41R

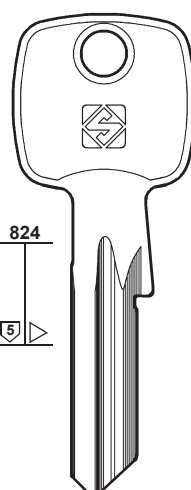

TO114RX
9 X
012345678

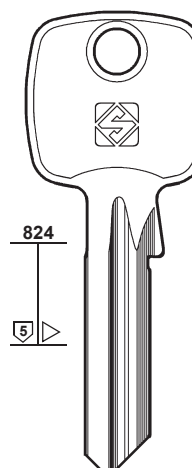

TO120RX

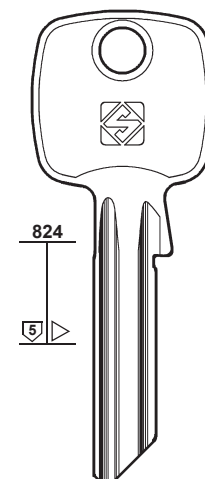

TO124RX
TO125X

PER:
FOR:

TOK-WINKHAUS

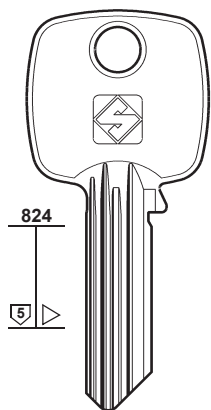

TO40 **TO42R**

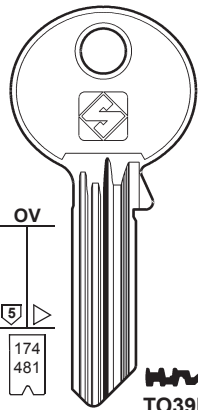

174
481
TO39R

TO30
9.....T
012345678

TO34

TO30R
9.....X
012345678
9.....T
012345678

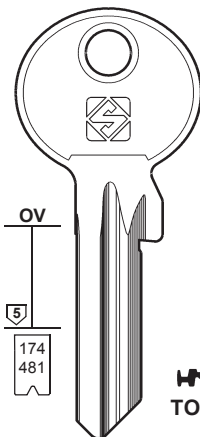

174
481
TO108X

TO30X
9.....T
012345678

TO30RX
9.....X
012345678
9.....T
012345678

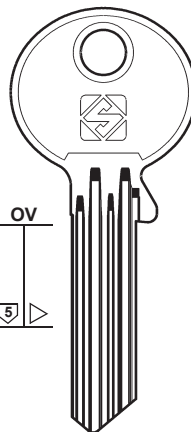

TO81R

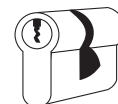

187

PER / FOR

TOK-WINKHAUS (DE)

AZBE
BIFFAR
EFAM
EGSA
ENAX
FICHET

TOP (DE)

ABUS
NOVA

+ ABUS (6)
+ WILKA (210)

TOR (IT)

ZANETTI A. (220)

TORÉ (DE)

CES (47)

TOUCH (GB)

PER:
FOR:

TOK-WINKHAUS

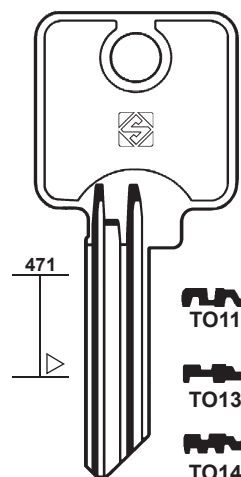

TO11

TO13

TO14
EGSA

TO21

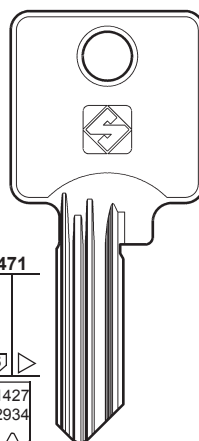

1427
2934

TO43

TO27
.....
0123456789

TO18

TO19

TO20R

TO33

TO45

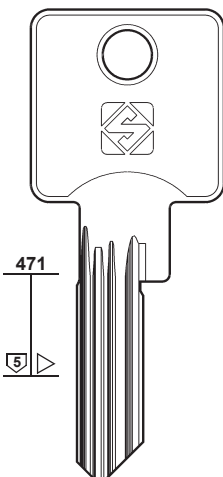

ENAX

TO52
ENAX

TO53
BFA1

TO55
FAABF

TO57
EHBA
EKCP

TO58
EFAM
EFWS

TO59
EWSB

TO60
BFA2

TO61
BFA3

TO64
BYNY1

TO65

TO91

TO100

TO104

TO105

TO106

TO107

TO111R

TO127

AZBE

AZBE

BIFFAR - FICHET

PER:
FOR:

TOP

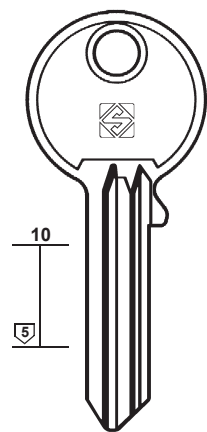

TOP1R

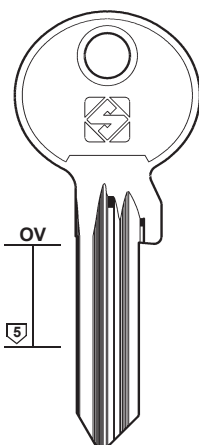

TOP1RX

ABUS - NOVA

TOUCH

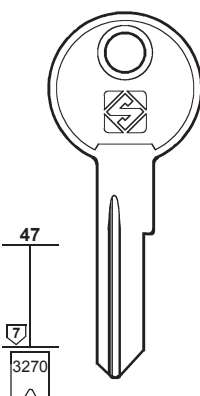

TOU1R
..... 12345

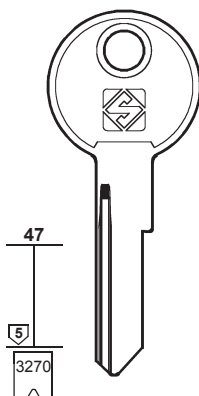

TOU2R
..... 12345

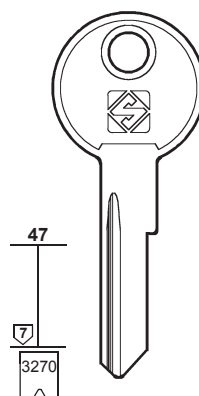

TOU3R
..... 12345





188

PER / FOR

TOVER (ES)

MASTER

TROMER

+ FTH (92)

TRABER (GB)

+ EURO LOCKS (80)

TRAINS (TW)

TRAU (IT)

PREFER

TRELOCK (DE)

WASO

+ TOK-TRELOCK (184)

+ TOK-WINKHAUS (186)

PER:
FOR:

TOVER

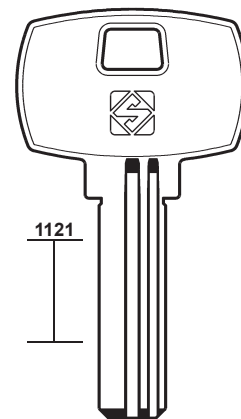
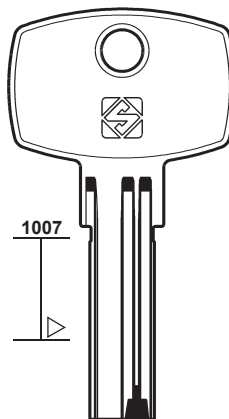
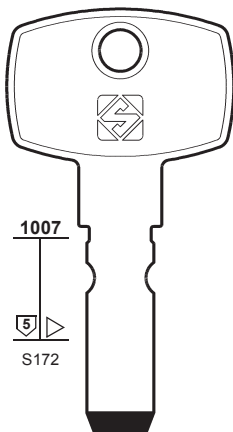
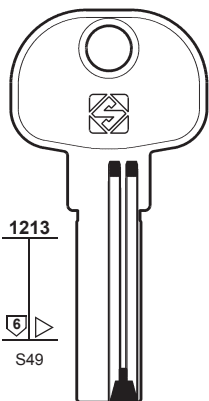

MASTER



TROMER



PER:
FOR:

TRAINS

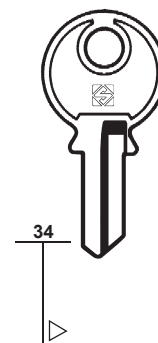
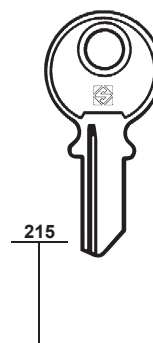
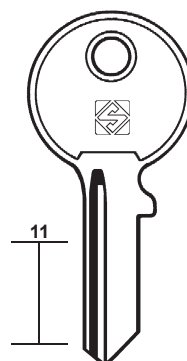
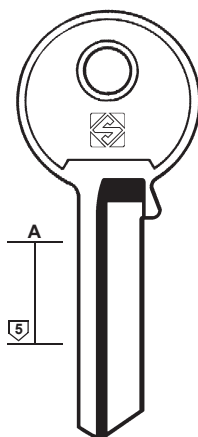
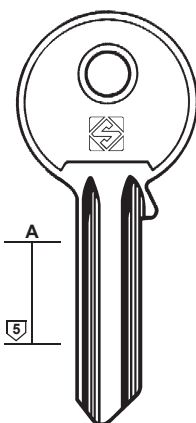

PER:
FOR:

TRAU

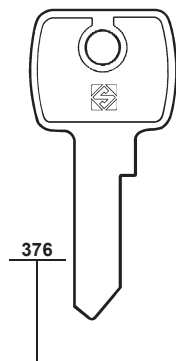

PREFER

TRELOCK

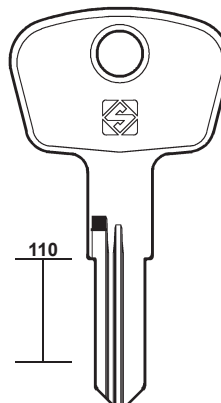
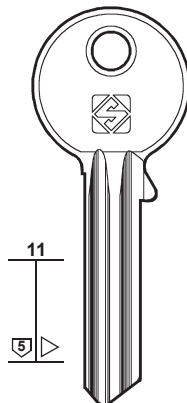

Red head
Testa rossa

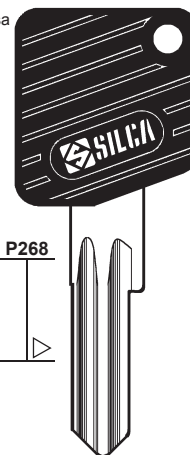

TRK4CP

WASO



PER:
FOR:

TRELOCK

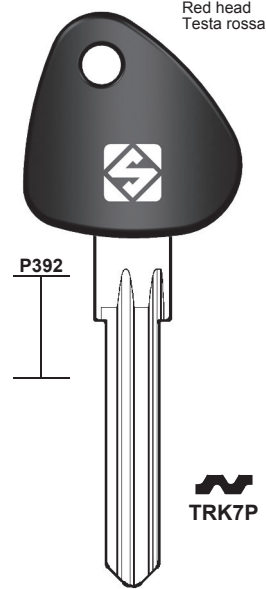
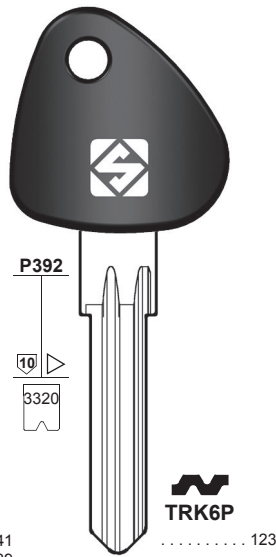
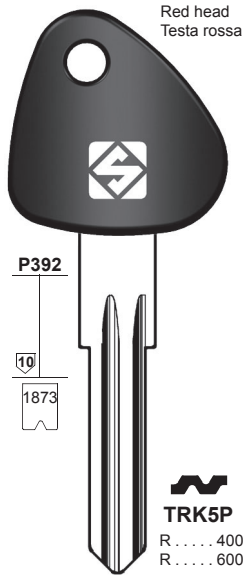
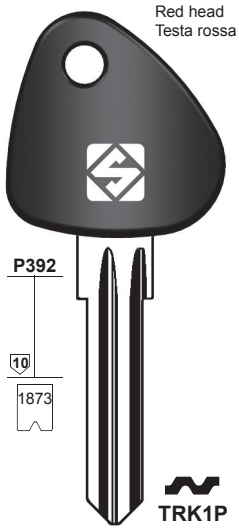

189

PER / FOR

TRELOCK (DE)
 + LUMA (130)
 + TOK-TRELOCK (184)
 + TOK-WINKHAUS (186)

TRI-CIRCLE (TW)
 ABUS
 ELEPHANT
 + DOUBLE CIRCLE (75)

PER:
FOR:

TRELOCK

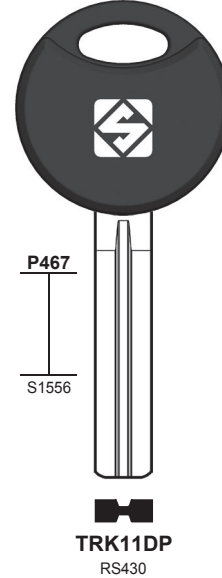
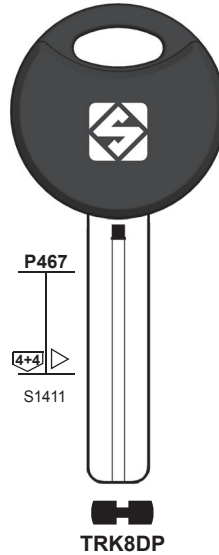
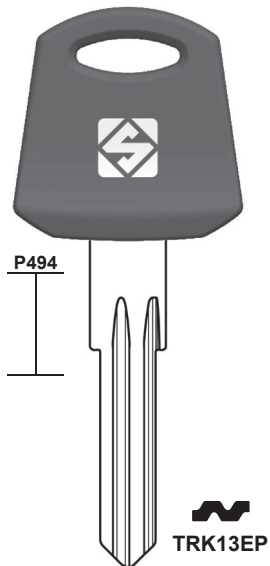
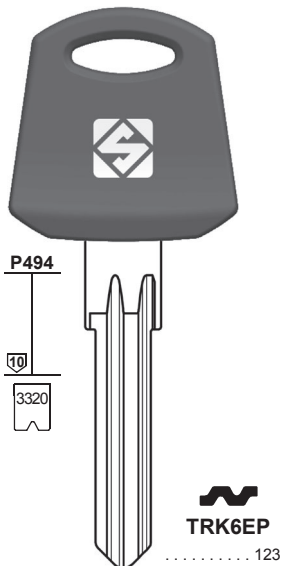

PER:
FOR:

TRI-CIRCLE

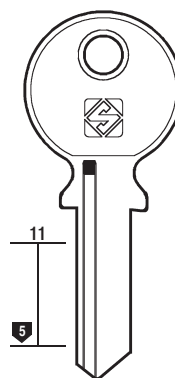
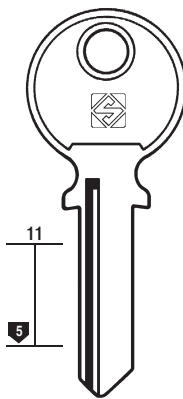
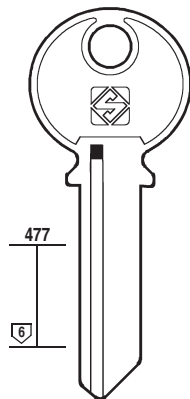
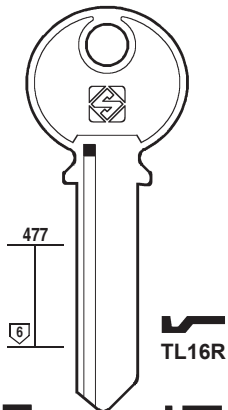



190

PER / FOR

TRI-CIRCLE (TW)
ABUS
MARK
YONGTAI
+ **DOUBLE CIRCLE (75)**

TRIMARK (US)

TRIO (NO)
 TRIOVING (190)

TRIOVING (NO)
TRIO

PER:
FOR:

TRI-CIRCLE

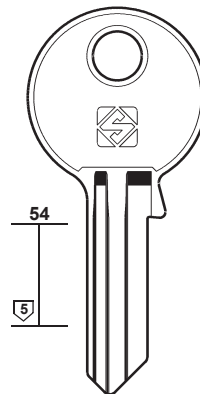
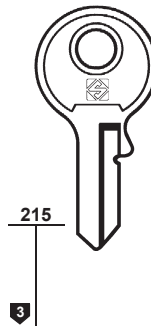
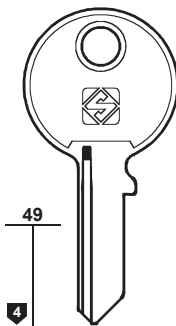
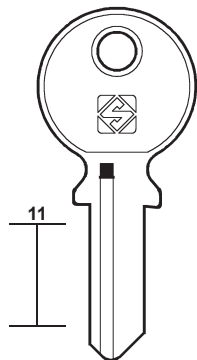

ABUS - MARK



PER:
FOR:

TRI-CIRCLE

TRIMARK

TRIOVING

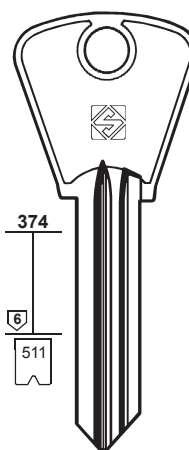
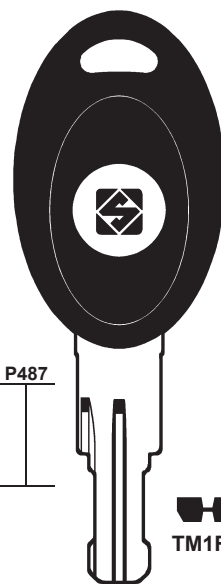
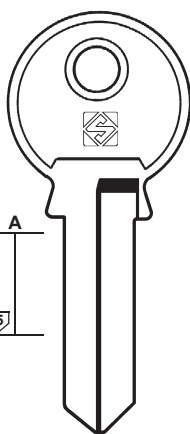
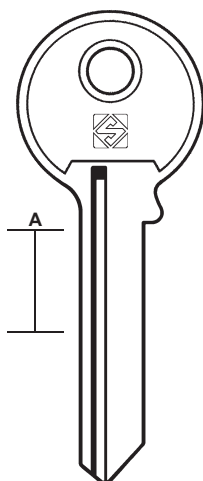

0-1-2-3-4-5-6-7-8-9-A

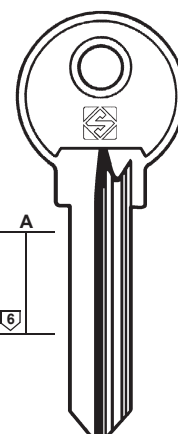

TRIO

PER:
FOR:

TRIOVING

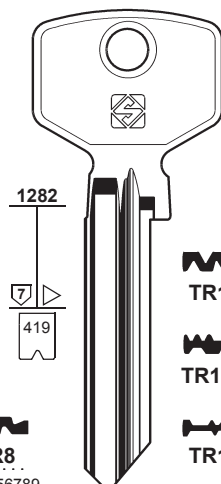

0123456789

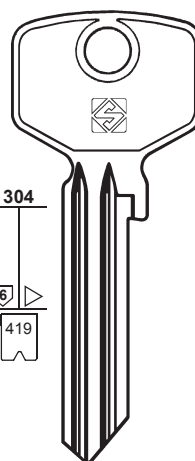

..... 0123456789
..... NK 1-18342
..... 1-26770
..... 30000-56769
..... ND 1-99999
D 1-13278
DCN 82660
..... 1-13278
..... 1-26770

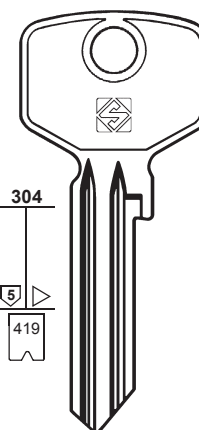

0-1-2-3-4-5-6-7-8-9

PER:
FOR:

TRIOVING

TRI STAR

TULA

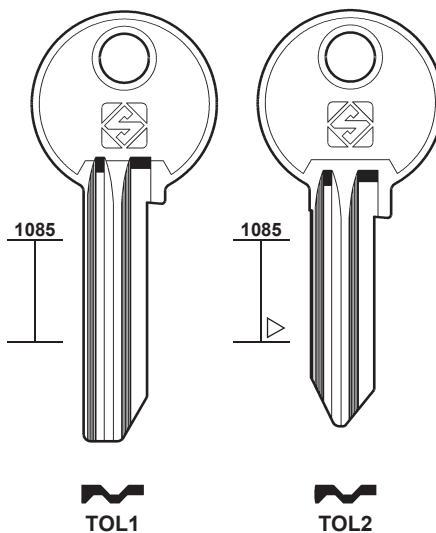
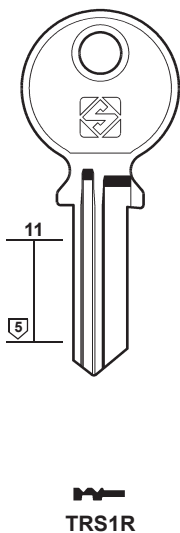
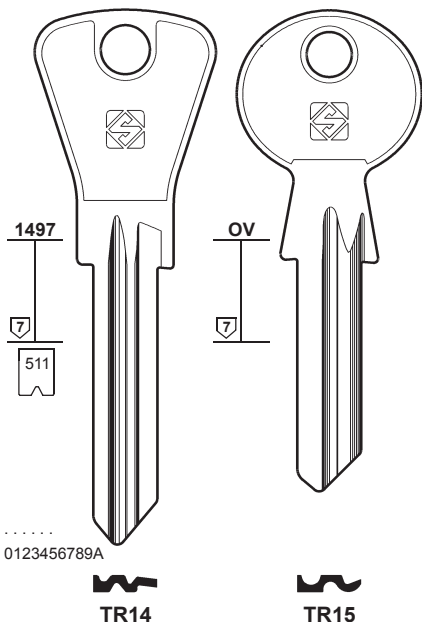

0123456789A

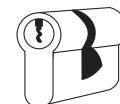

191

PER / FOR

TRIOVING (NO)

TRI STAR (TW)

TRITON (DE)

👁️ CES (47)

👁️ JOWIL (110)

TROMER (ES)

👁️ MCM (134)

👁️ TOVER (188)

TRUMPF (DE)

👁️ TH (182)

TRYBA (AT)

👁️ EVVA (80)

TULA (RU)

TUSHINO (RU)

TÜRSCHLOSS (DE)

👁️ TAS (180)

TWINLOCK (GB)

TWIRHONB (FR)

👁️ ASIA (20)

TZAFRER (GR)

+ 👁️ CISA (55)

+ 👁️ GEGE (93)

UAP (GB)

PER:
FOR:

TUSHINO

TWINLOCK

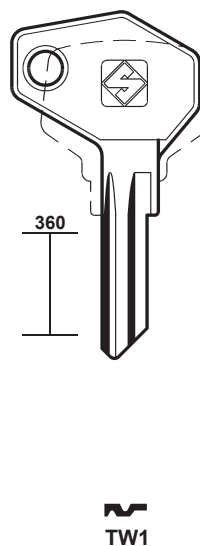
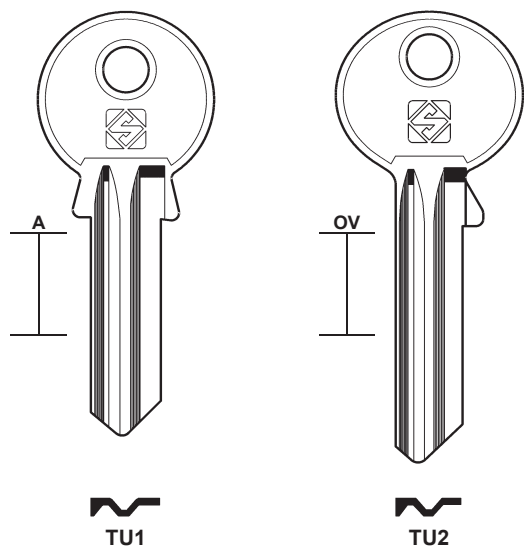

PER:
FOR:

TZAFRER

UAP

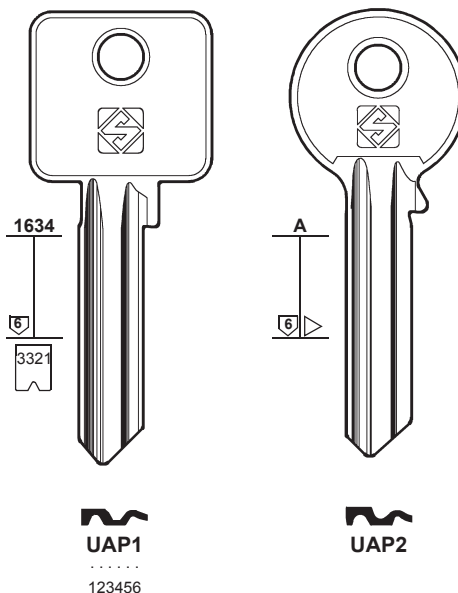
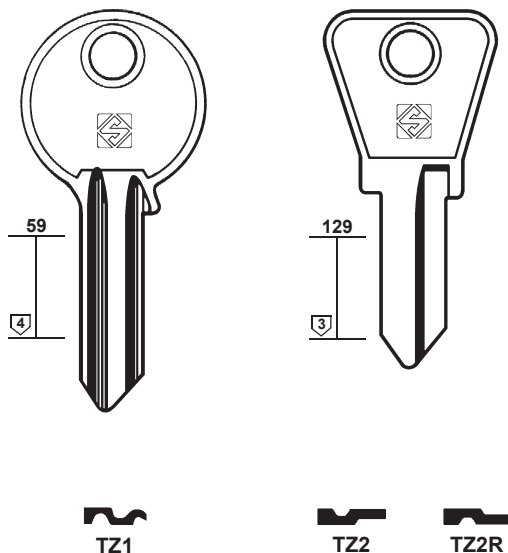



192

PER / FOR

UCEM (ES)
 CIB
 ESAFE
 ISEO
 RIV
 YEMAR

UEME (BR)

ULIANOVSK (RU)

ULTRA (GB)
 L & F (128)

UMF (PT)
 + YALE (213)

UNIFERRO (FR)
 CISA (55)

UNIFOR (IT)
 PREFER (157)

PER:
FOR:

UCEM

29
5
811

1204
5

P244
5
S170
S196

1203
5
S170
S196

1203

UC2

UC1 **UC1R**
..... 1-2-3-4-5-6

UC6R

UC3RP
2000S

UC5R

UC4R

CIB - RIV

**ESAFE - ISEO
YEMAR**

PER:
FOR:

UCEM

UEME

1386

1156

1156
5

1292
4

UC8R

UE5R

UE4R

UE2R

PER:
FOR:

UEME

ULIANOVSK

UMF

1292
5

1088

54

A

UE3R

ULS1R

UM1 **UM1R**

UM2

PER:
FOR:

UNION



193

PER / FOR

UNION (GB)
HENDERSON
ONIUN

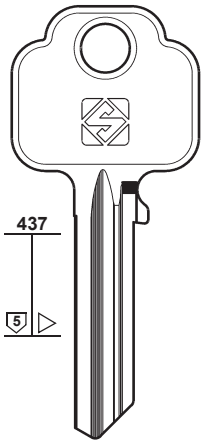

UNI66R
B-MLA

UNI68R
NE

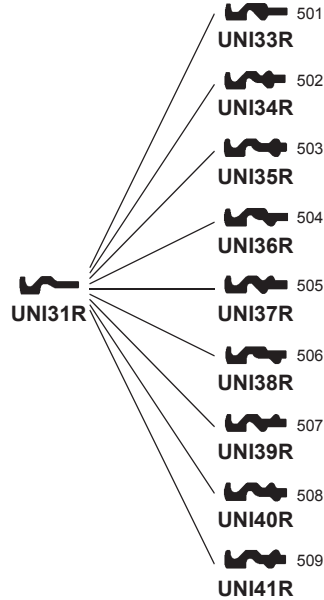
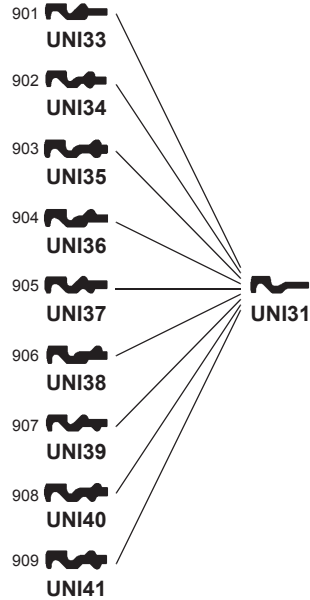

PER:
FOR:

UNION

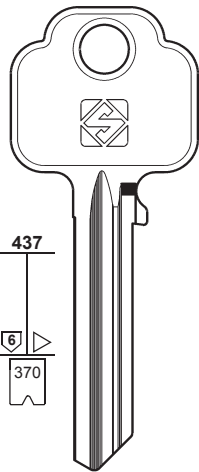

UNI67R
B-MLA

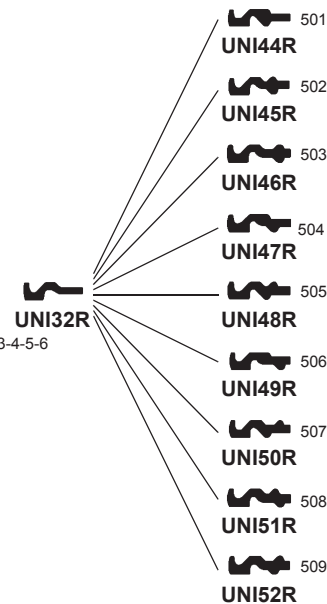
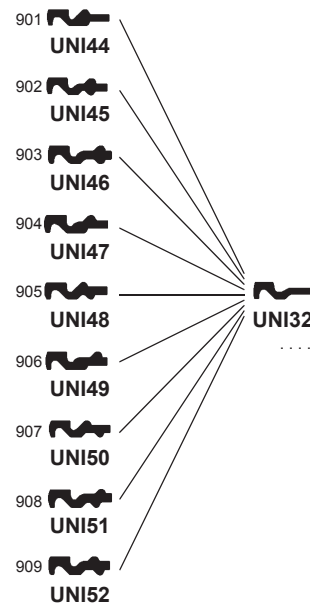

PER:
FOR:

UNION

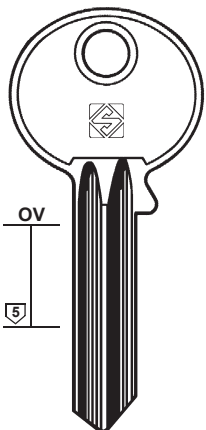

UNI28
KB506

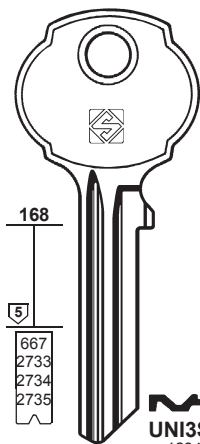

UNI3
KB502
..... 1-2-3-4-5-6
..... 1-2-3-4-5-6-7-8

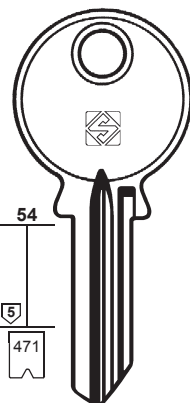

UNI54R
ZA1

UNI18
NJ ...
1-1500

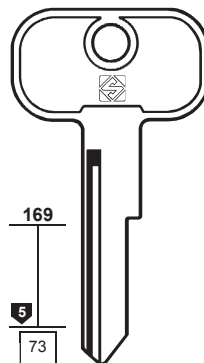

UNI6
FR ... 751-875

UNI16
... 1-99
FS ... 1-99
FS ... 876-955

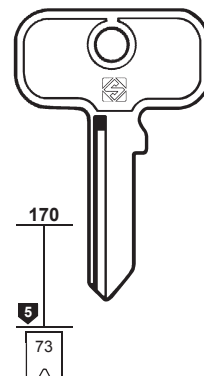

UNI7
FP ... 626-750
HENDERSON

UNI16R
FK ... 1-99
FK ... 876-955

UNI11
FP ... 626-750

UNI14
... 1-99
FS ... 1-99
FS ... 876-955

ONIUN



194

PER / FOR

UNION (GB)

UNIVERSAL

PER:
FOR:

UNION

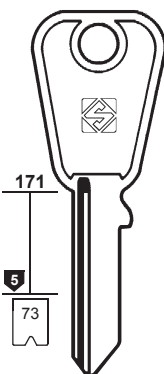

UNI12

FP ... 626-750



UNI15

... 1-99
FS ... 1-99
FS ... 876-955

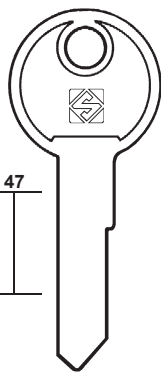

UNI29

KB682

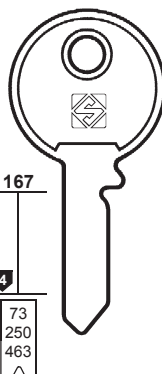

UNI4

NRA
FFE ... 1-100
FL ... 251-500
NRA ... 51-90
FG ... 1-30
NF ... 1-30
EJR ... 1-75
FMO ... 1-75

UNI4R

EJR ... 1-75



UNI5

NGN ... 1-54



UNI63

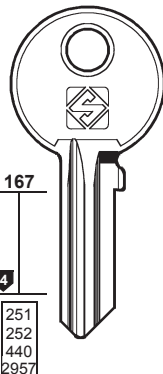

UNI27

KB53A



NKL ... 151-300
NND ... 151-300
TBS ... 201-350

NKW/A ... 1001-1100
NKW/A ... 1-100
NKW/X ... 1-100
NKW/H ... 1-50
NKL ... 301-450
NND ... 1-150
NND ... 301-450
NPK ... 1-100

TBS ... 1-100
NKL ... 1-150
NND ... 1-150
TBS ... 1-50
TBS ... 101-200
TBS ... 201-300
TBS ... 201-350
TBS ... 301-400
TBS ... 401-500



UNI22



UNI23



UNI30



UNI56R



UNI57R



UNI58R



UNI61R



UNI61

TBS ... 201-350
RV ... 1-450

PER:
FOR:

UNION

UNIVERSAL SERIE DISTINZIONE

HEAD TYPE / TESTA TIPO **N**

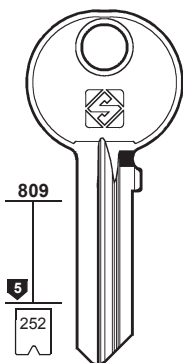

UNI59R

NKW/A ... 1-100
NKW/A ... 1001-1100
NPK ... 1-100



NKW/X ... 201-300
NKW/A ... 201-300

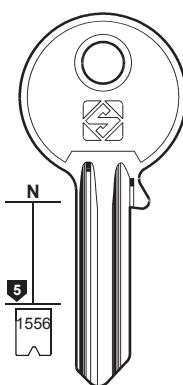

UL058

... 123456



UL059

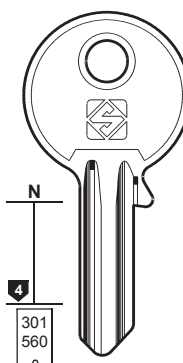

UL060

... 501-700
... 1001-1500



UL061

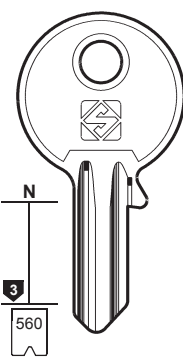

UL056

... 1701-1810
... T 1-113



UL057

PER:
FOR:

UNIVERSAL SERIE DISTINZIONE

HEAD TYPE / TESTA TIPO **A**

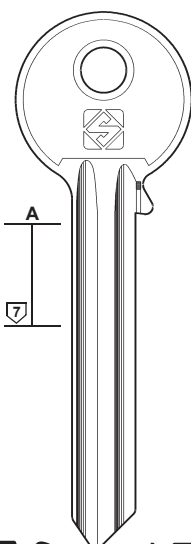

UL046

UL047

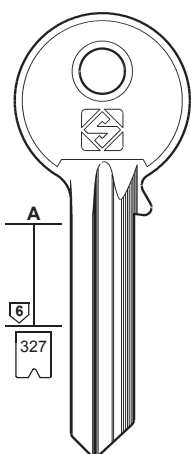

UL054 ... 123456

UL055

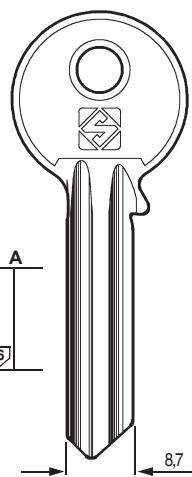

UL064

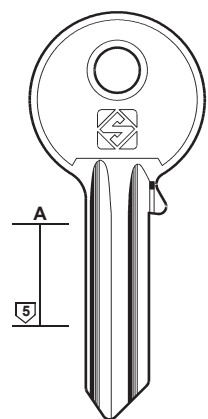

UL050

UL051

PER:
FOR:

UNIVERSAL SERIE DISTINZIONE

HEAD TYPE / TESTA TIPO A



195

PER / FOR

UNIVERSAL

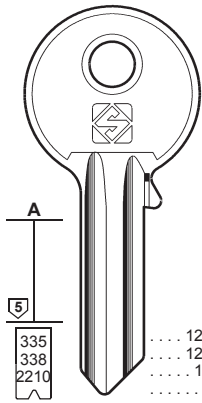

UL062

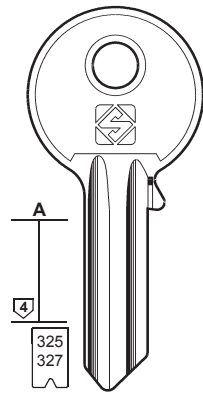

UL052 0123456789
..... 123456

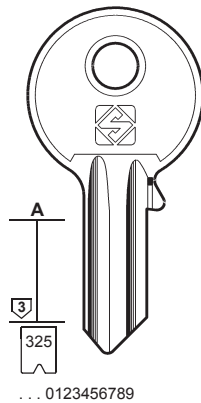

UL048

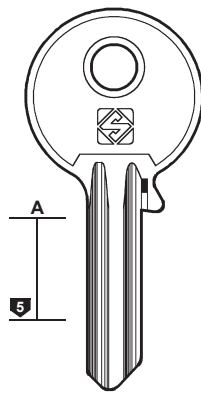

UL058A



PER:
FOR:

UNIVERSAL SERIE DISTINZIONE

HEAD TYPE / TESTA TIPO B

HEAD TYPE / TESTA TIPO C

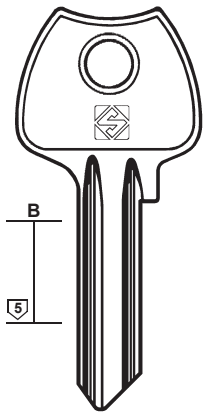

UL050B

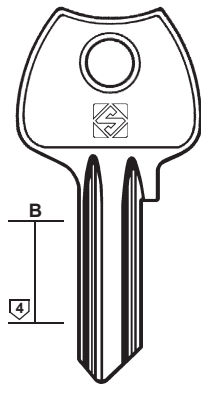

UL052B

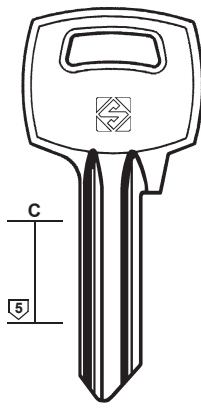

UL050C

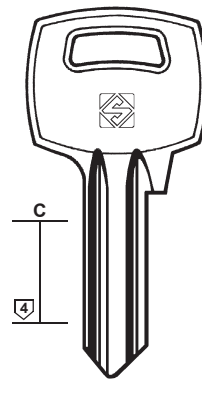

UL052C



PER:
FOR:

UNIVERSAL SERIE DISTINZIONE

HEAD TYPE / TESTA TIPO D

HEAD TYPE / TESTA TIPO DC

HEAD TYPE / TESTA TIPO E

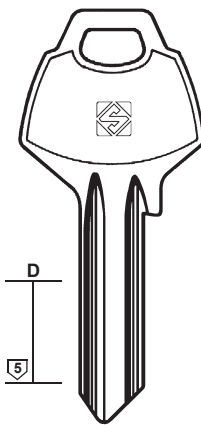

UL050D

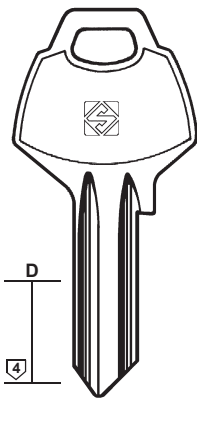

UL052D

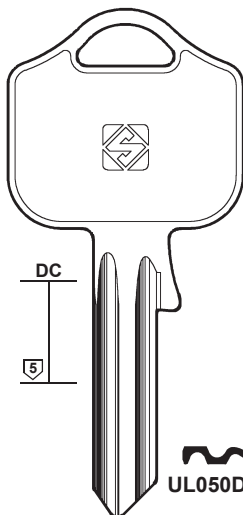

UL050DC

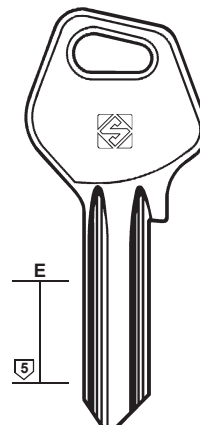

UL050E

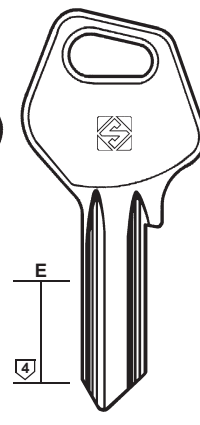

UL052E





196

PER / FOR
UNIVERSAL

PER:
FOR:

UNIVERSAL SERIE DISTINZIONE

HEAD TYPE / TESTA TIPO **F**

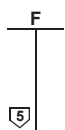
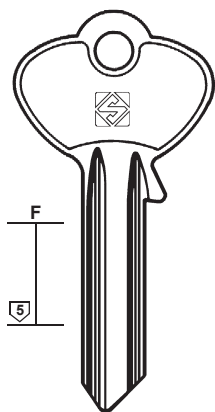

UL050F

UL051F

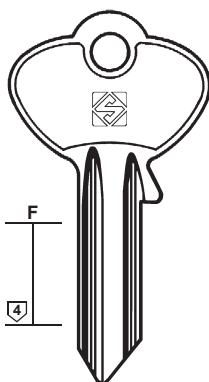

UL052F

HEAD TYPE / TESTA TIPO **G**

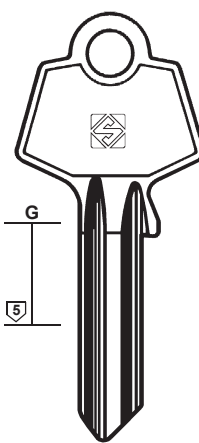

UL050G

UL051G

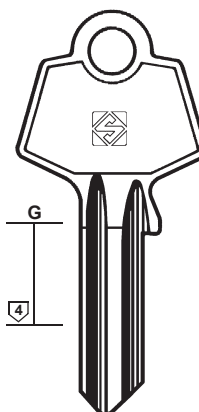

UL052G

UL053G

PER:
FOR:

UNIVERSAL SERIE DISTINZIONE

HEAD TYPE / TESTA TIPO **H**

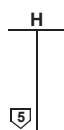
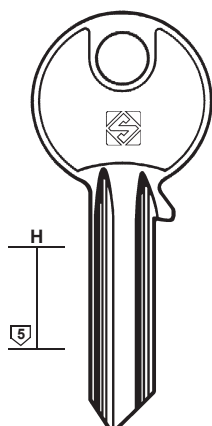

UL050H

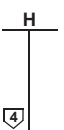
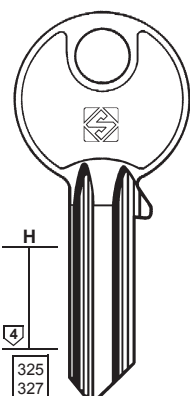

325
327
330
335
338

UL052H

..... 012345678
..... 0123456789
..... 12345
..... 123456

HEAD TYPE / TESTA TIPO **L**

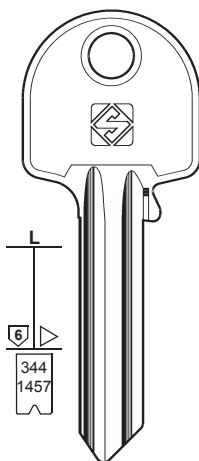

UL054L

UL055L 12345678
..... 123456789

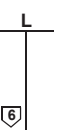
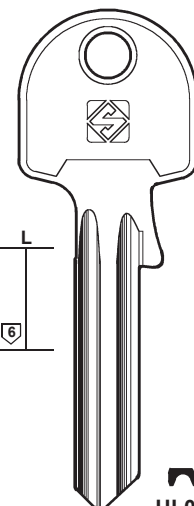

UL054SL

UL055SL

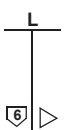
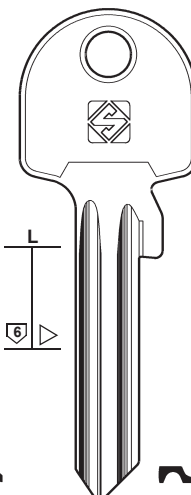

UL054XL

UL055XL

PER:
FOR:

UNIVERSAL SERIE DISTINZIONE

HEAD TYPE / TESTA TIPO **L**

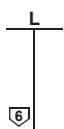
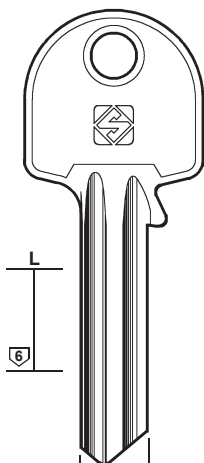

UL064L

UL050L

UL051L

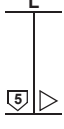
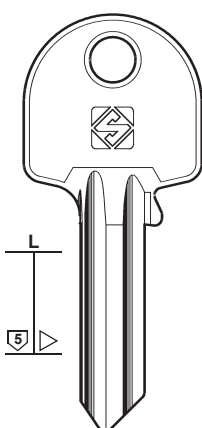

UL050L

UL051L

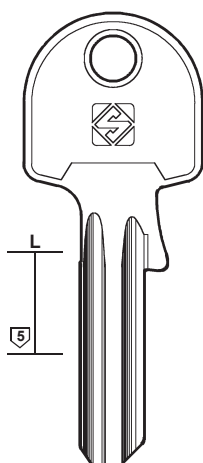

UL050SL

UL051SL

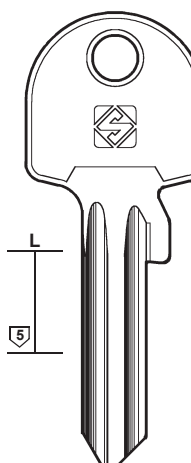

UL050XL

UL051XL

PER:
FOR:

UNIVERSAL SERIE DISTINZIONE

HEAD TYPE / TESTA TIPO **L**

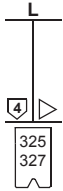
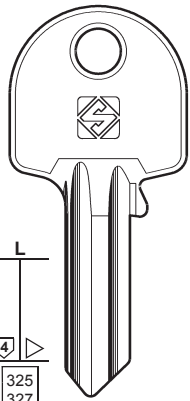

 0123456789
UL052L 123456

UL053L 123456

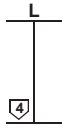
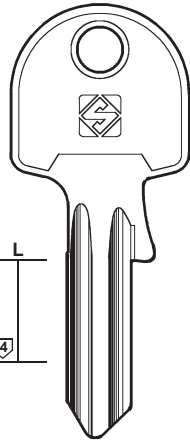

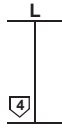
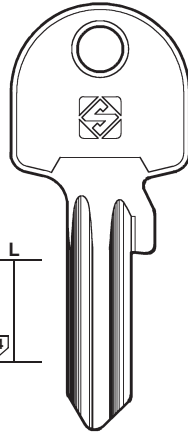

UL052SL

UL053SL

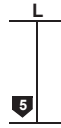
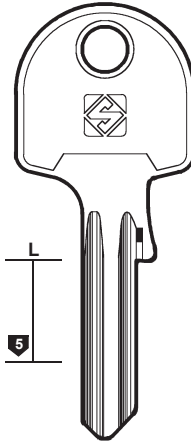

UL052XL

UL053XL



UL058SL



197

PER / FOR

UNIVERSAL

U.P.R. (DE)

URBIS (RO)
BSS
YALE

PER:
FOR:

UNIVERSAL SERIE DISTINZIONE

HEAD TYPE / TESTA TIPO **M**

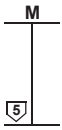
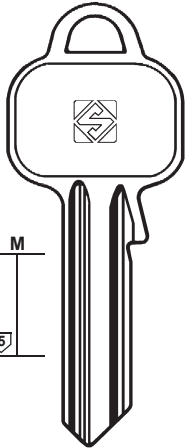

UL050M

UL051M

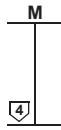
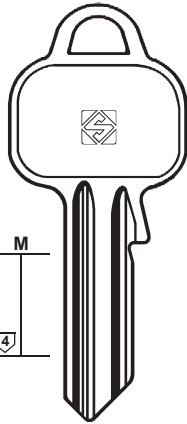

UL052M

UL053M

HEAD TYPE / TESTA TIPO **OV**

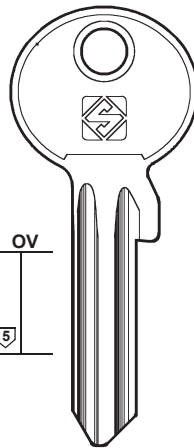

UL050X

UL051X

HEAD TYPE / TESTA TIPO **Y**

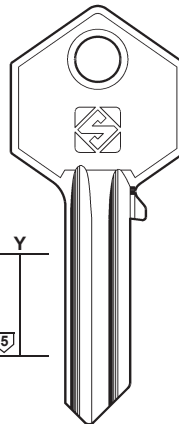



UL050Y

UL051Y

PER:
FOR:

U.P.R.

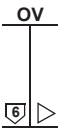
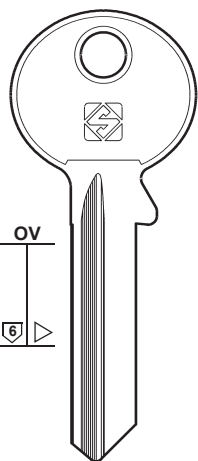
URBIS



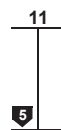
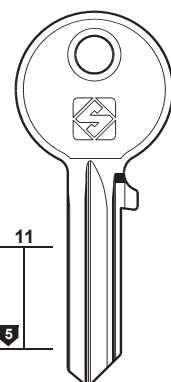

UP1



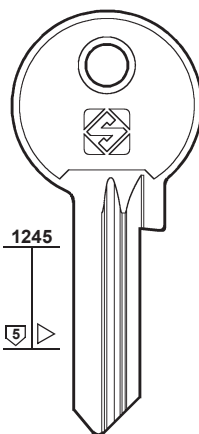

UB1R

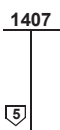
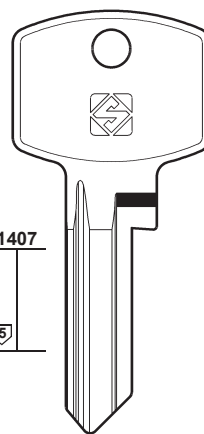

UB2R

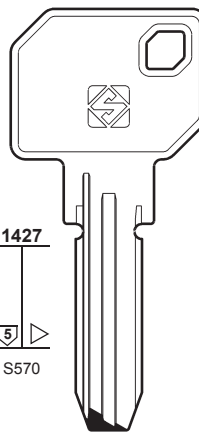

UB5



UB3

.....
1-7802880

YALE



BSS - YALE



198

PER / FOR

URKO (ES)

UTZ (CH)

- FORT (90)
- L & F (128)
- SIS (170)

VACHETTE (FR)

- ATAL
- DAD
- ISEO
- KILT
- JU
- RUKA
- SANPEUR
- VINCO
- + ISEO (108)
- + KWIKSET (119)
- + TITAN (183)
- + TOK-WINKHAUS (186)
- + VEGA (204)

URKO

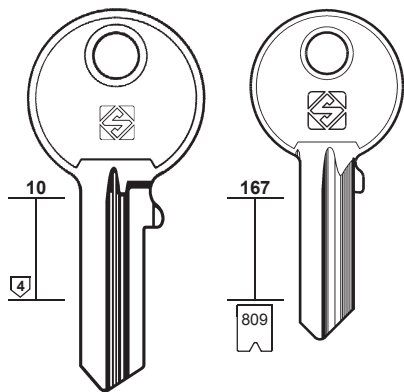

UR1 UR1R UR2 UR2R
1-2-3-4-5-6

VACHETTE

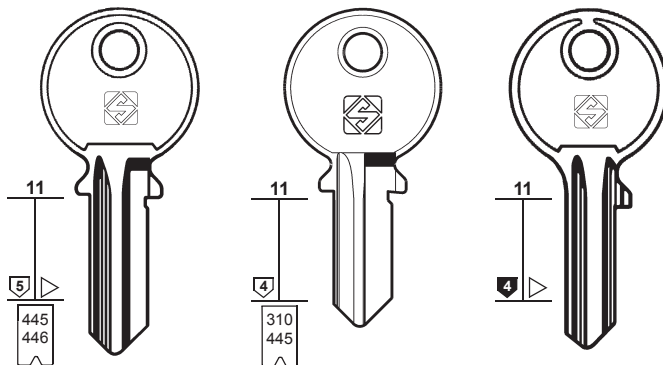

VAC46 VAC1 VAC1R VAC8 VAC8R
 1-2-3-4-5-6-7-8
 1-2-3-4-5-6-7-8
 E 1-2-3-4-5-6-7-8-9-0
 9001-9100
 E 300-499
 R 9001-9100
 1-2-3-4-5-6-7-8-9-0
 1-2-3-4-5-6-7-8-9-0
 E 1-2-3-4-5-6-7-8-9-0

mm 40-50-60
 mm 30
ISEO - KILT
SANPEUR

VACHETTE

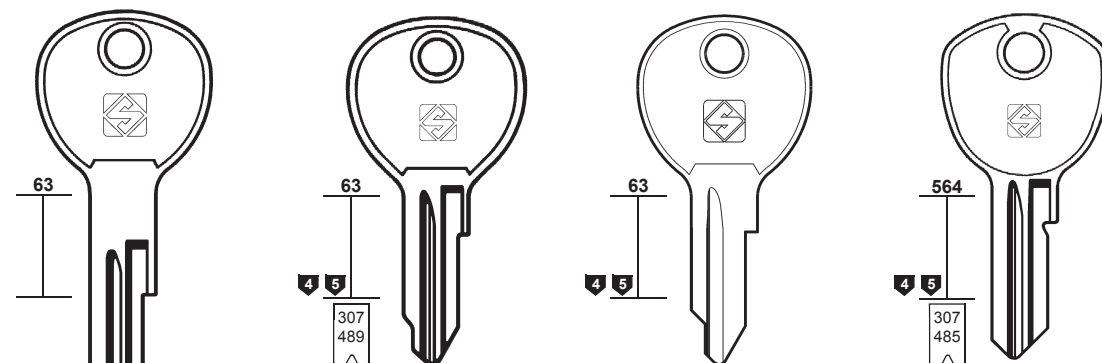

VAC44R VAC25 VAC25R VAC106 VAC106R VAC65 VAC65R
 R... 0-423 G... 0-423 D... 0-321 RS GS R... 0-423 G... 600-644 R... 0-423 G... 600-644
VAC100 VAC100R VAC33 VAC33R VAC107 VAC107R VAC66 VAC66R
 V... 0-423 W... 0-423 VS WS V... 0-423 W... 600-644 V... 600-644 W... 600-644

VINCO ATAL - VINCO ATAL - VINCO

VACHETTE

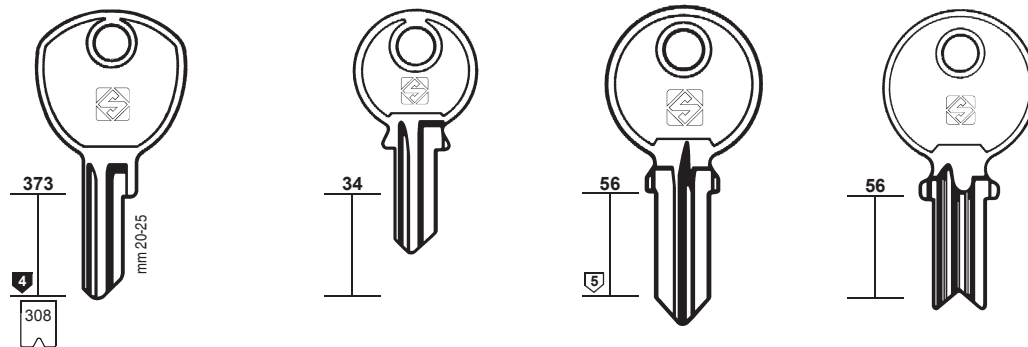

VAC42 VAC42R
 BL... (G) A0-H9 RL... A0-H9
 K... A0-H9 LR... (G) 0-49
 LB... 0-49
 LG... 0-49

VAC60 VAC60R
 VL... (V) A0-H9 WL... (W) A0-H9
 LV... 0-49 LW... 0-49

VAC11 VAC10 VAC11R

DAD - JU **RUKA**

PER:
FOR:

VACHETTE

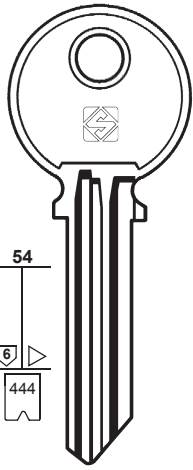

RO41

..... 1-1296
..... 1-2-3-4-5-6-7-8-9-0
V20 1-1296
A/Z 1-2-3-4-5-6-7-8-9-0



DAD - RONIS

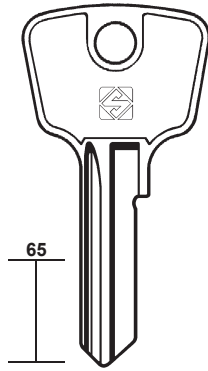

VAC14



mm 40-50-60

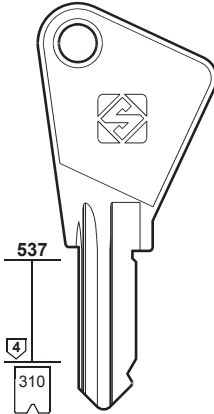

VAC61

EE 9001-9100
E 2-3-4-5-6

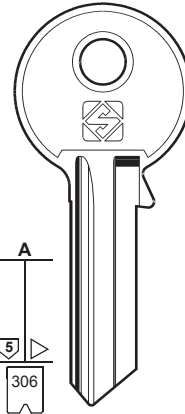

VAC29

A1 5001-5631

**FONTAINE - HEMA
METALUX - MODERN BAU**



199

PER / FOR

VACHETTE (FR)
DAD
FONTAINE
HEMA
METALUX
MODERN BAU
RONIS
+ ISEO (108)
+ KWIKSET (119)
+ TITAN (183)
+ TOK-WINKHAUS (186)
+ VEGA (204)

PER:
FOR:

VACHETTE

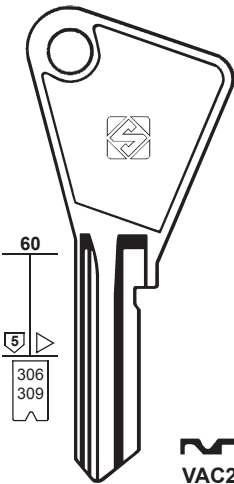

VAC2

A1 5001-5631
UL 1-3500
U 1-2-3-4-5-6-7-8-9-0
U0 1-9999
JA 0001-1252
UB 0001-5002
UA 0830-6334
LA 0000-6334

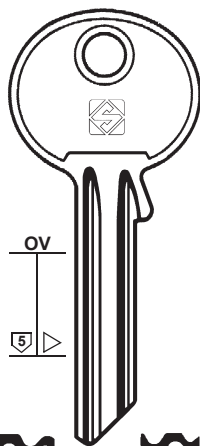

VAC30

VAC30R

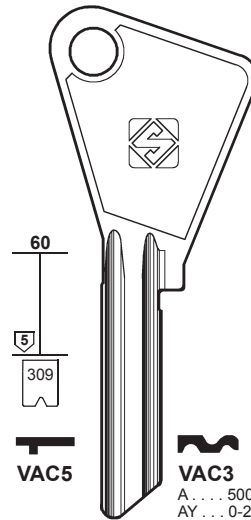

VAC5

VAC3

A 5000-5635
AY 0-249
Y 0-249
AS 0-099
S 0-099
A 2000-2999
A 3000-3199
AA 0000-1999



mm 30-45

PER:
FOR:

VACHETTE

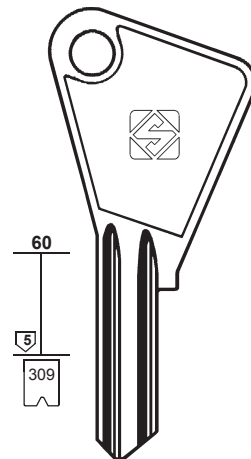
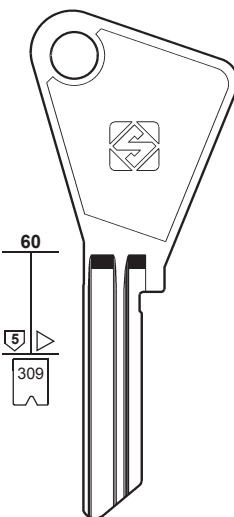

VAC4

AY 0-249
Y 0-249

VAC56
AM 870-894

VAC47
BM 870-894

VAC57
CM 870-894

VAC58
DM 870-894



VAC63
AM 870-894
BM 870-894
CM 870-894
DM 870-894



200

PER / FOR

VACHETTE (FR)

- + ISEO (108)
- + KWIKSET (119)
- + TITAN (183)
- + TOK-WINKHAUS (186)
- + VEGA (204)

PER:
FOR:

VACHETTE

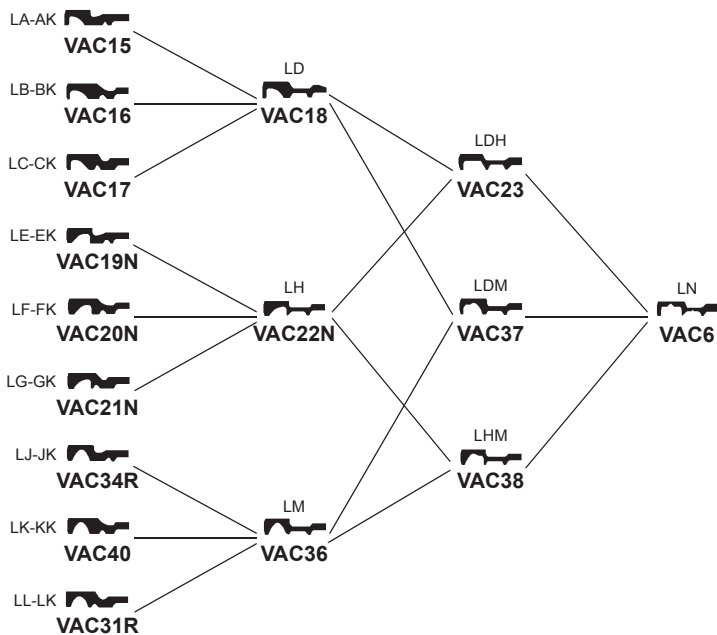
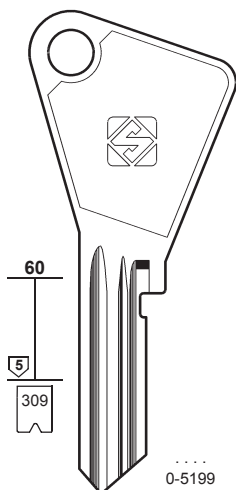

PER:
FOR:

VACHETTE

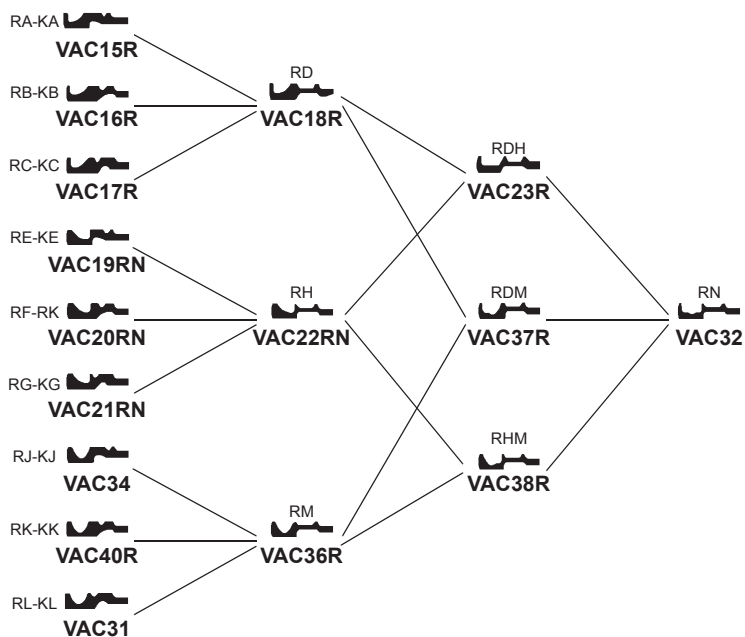
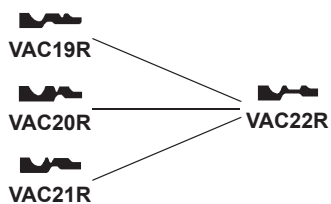
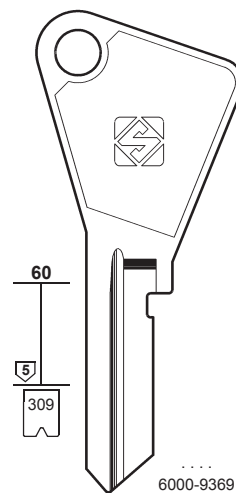

PER:
FOR:

VACHETTE



201

PER / FOR

VACHETTE (FR)
 AZMA
 CAP
 + ISEO (108)
 + KWIKSET (119)
 + TITAN (183)
 + TOK-WINKHAUS (186)
 + VEGA (204)

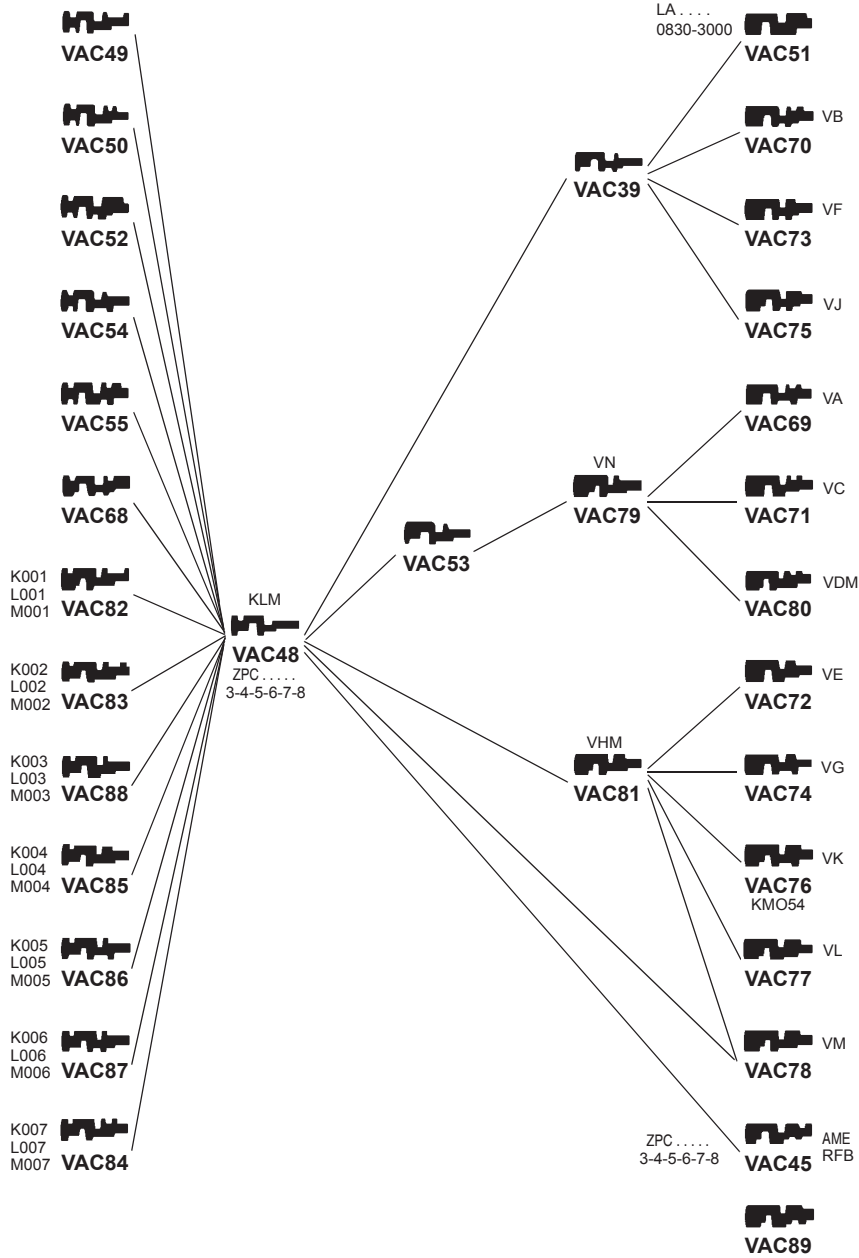
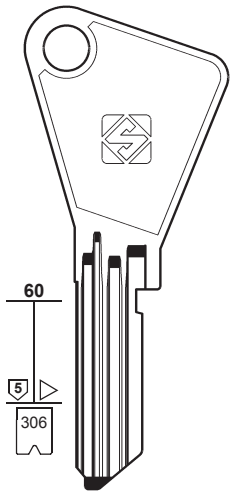

AZMA - CAP



202

PER / FOR

VACHETTE (FR)
LAPERCHE

- + ISEO (108)
- + KWIKSET (119)
- + TITAN (183)
- + TOK-WINK-HAUS (186)
- + VEGA (204)

PER:
FOR:

VACHETTE

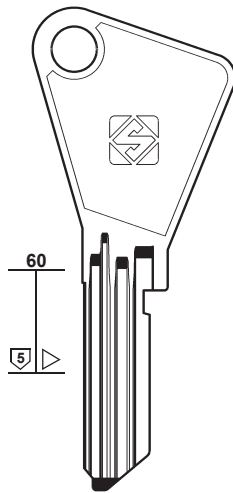

VAC101
KM235

VAC108
K200

VAC109
L202

VAC110
L226

VAC111
L229

VAC112
L230

VAC113
L240

VAC114
KL229

VAC115
K247

VAC116
KM236

VAC117
M258

VAC118
L225

VAC119
L243

VAC120
K023

VAC121
K024

VAC122
K025

VAC123
K234

VAC124
K235

VAC125
K236

VAC126
K237

VAC127
K238

VAC128
K239

VAC129
K240

VAC130
K242

VAC131
K243

VAC132
K244

VAC133
K245

VAC134
P294

VAC135
L019

VAC136
L020

VAC137
L021

VAC138
L022

VAC139
L223

VAC140
L224

VAC141
L227

VAC142
L228

VAC143
L239

VAC144
L244

VAC145
L245



VAC146
L246

VAC147
K020

VAC148
K021

PER:
FOR:

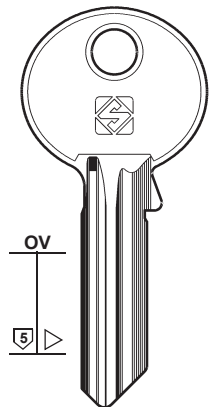
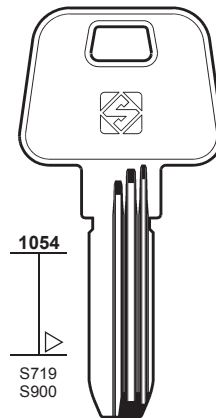
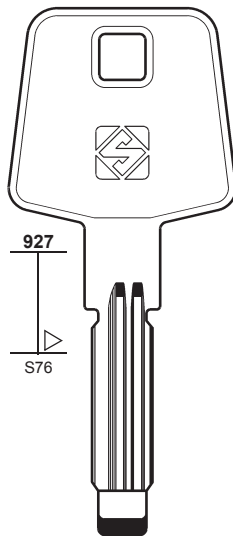
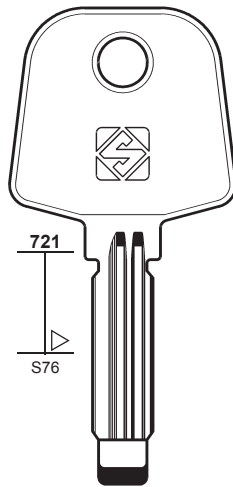
VACHETTE



VAC91



VAC103



VAC104



VAC105



VAC150
V6



VAC151



RADIAL



RADIAL



LAPERCHE

PER:
FOR:

VACHETTE

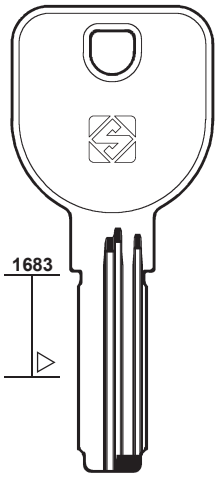

1683



VAC152

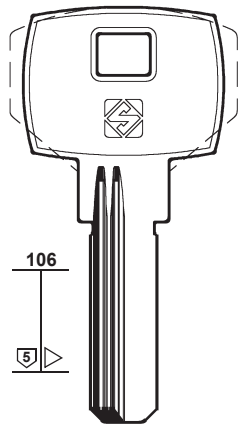

106



VAC153R



VALE

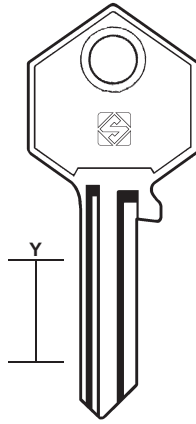

Y



VAL1

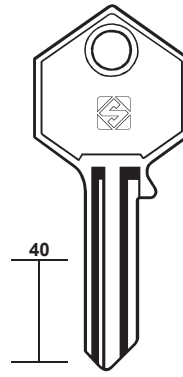

40



VAL2



203

PER / FOR

- VACHETTE (FR)
- + ISEO (108)
- + KWIKSET (119)
- + TITAN (183)
- + TOK-WINKHAUS (186)
- + VEGA (204)

- VADETO (DE)
- + BLASER (36)

- VALE (TW)

- VANGUARD (AR)

- VAN VAULT (GB)

- VARIO (DE)
- + DOM (70)

- VARIOS (ES)

- VASAR (RU)

- VAUGHN (GB)
- + HTV (103)

PER:
FOR:

VANGUARD

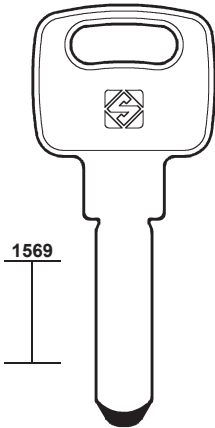

1569



VGD1



VAN VAULT

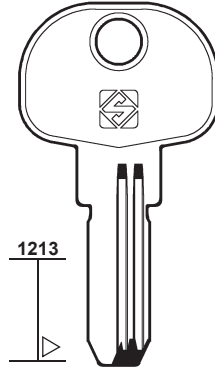

1213



VAV1



VARIOS

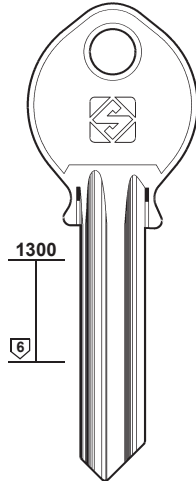

1300

6



VAR1

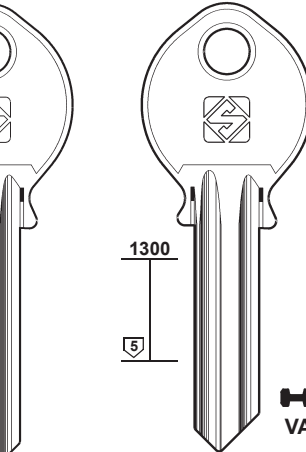

1300

5



VAR1R



VAR2



VAR2R



VAR5

PER:
FOR:

VARIOS

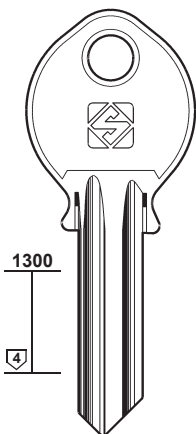

1300

4



VAR3



VAR3R

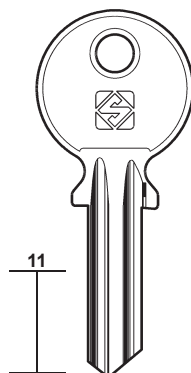

11



VAR4



VAR4R

VASAR

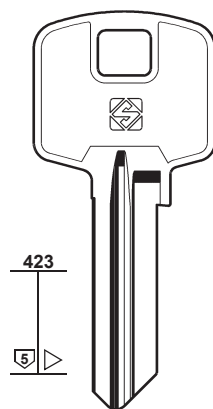

423

5



VSR1R

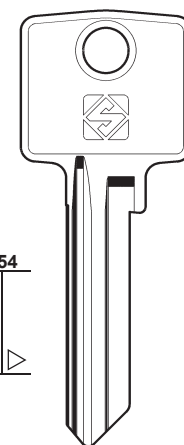

454

6



VSR2



VSR2R



204

PER / FOR

VBH (DE)

- + FCV (87)
- + WILKA (210)

VDO (DE)

- + KIENZLE (117)

VECO (ES)

VEGA (FR)

VACHETTE

- + ANTAR (18)
- + RONIS (161)

VELO (TW)

- + YETI (218-219)

VENLOCK (VE)

- + WILSON BOHANNON (211)

VERA (CO)

- + SATURN (165)

VEROFER (RO)

VERSCO (DE)

- + CORBIN (60)

V.G.F. VILLATORE (IT)

- + P.C. CORTELLEZZI (154)

VIDMAR (CH)

- + SEA (166)

VIKI (DE)

- + DOM (70)

PER:
FOR:

VBH

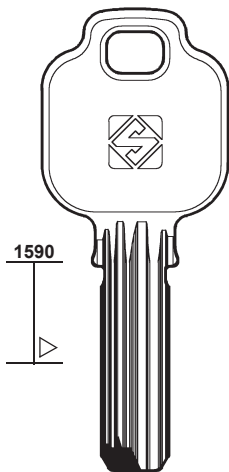

VBH1R



VECO

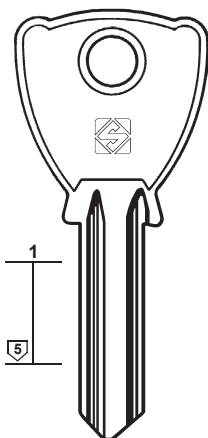

VC1



VC1R

VEGA

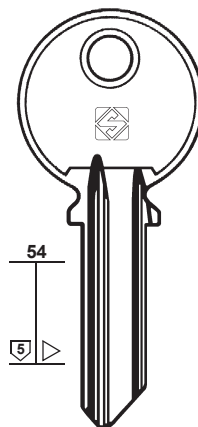

VEG1

VACHETTE

PER:
FOR:

VERA

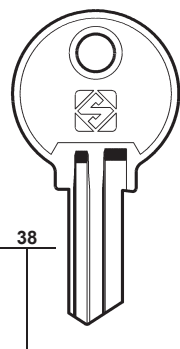

VR1

VEROFER

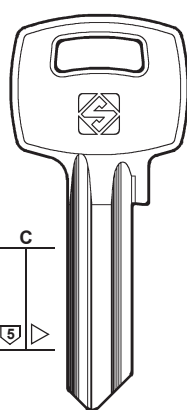

VRF3

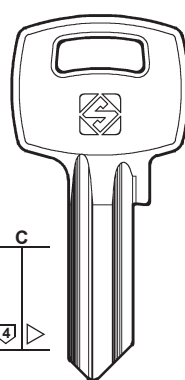

VRF4

V.G.F. VILLATORE

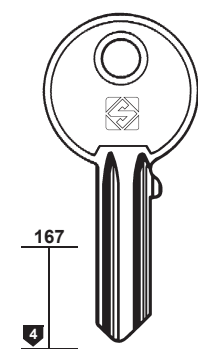

VL4



VL4R

PER:
FOR:

V.G.F. VILLATORE

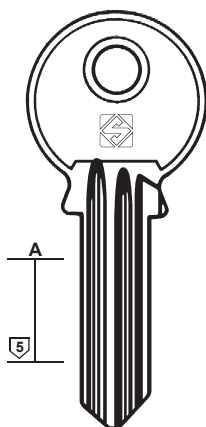

VL3



VL3R

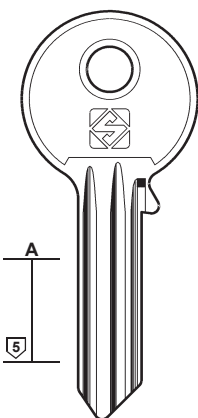

VL2



VL2R

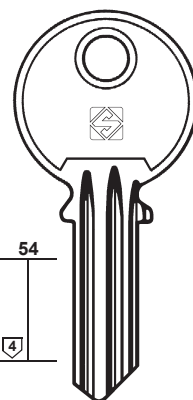

VL1



VL1R

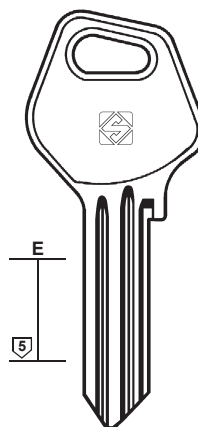

VL5E



VL5RE

PER:
FOR:

VINCO

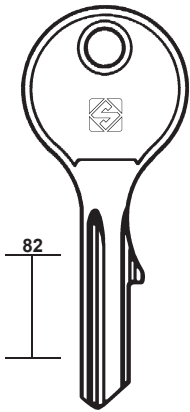

KARDEX

VING

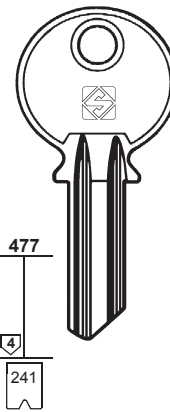
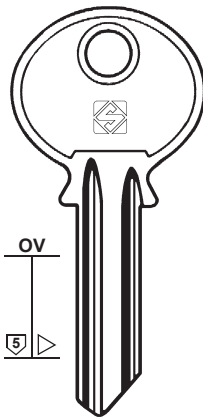
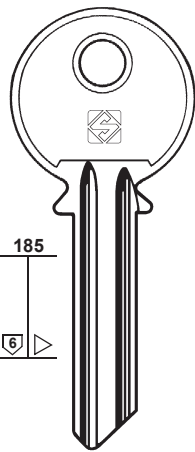

L. 5401-5650

NOBO



205

PER / FOR

VINCO (DE)
KARDEX
+ VACHETTE (198)

VING (NO)
NOBO

VIOMETAL (FR)
 EURO LOCKS (79)

VIP (FR)
 CITY (58)

VIRO (IT)
FEB
KÖNIG
+ ABLOY (5)
+ ELCA (76)
+ FAI (85)
+ TESA (182)

PER:
FOR:

VIRO

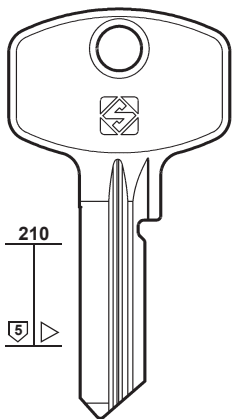

VI15R

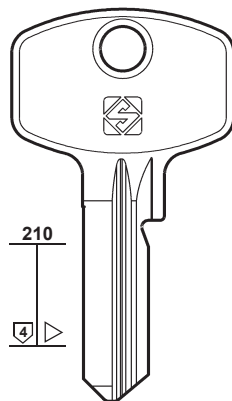

VI16R

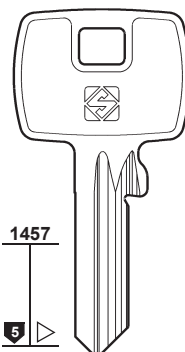

VI18R

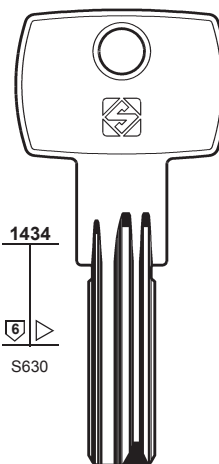

VI19
EURO-PRO



FEB

KÖNIG

PER:
FOR:

VIRO

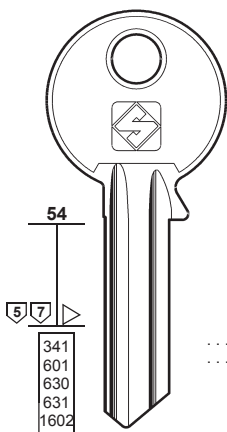

54
5 7
341
601
630
631
1602

VI8
 VI8R
K
 VI3
..... 012345
..... 6543210
 VI3R
..... 012345
..... 6543210

..... 012345
..... 01234567
..... 012345

VI5
..... 012345
..... 01234567
 VI5R
TS

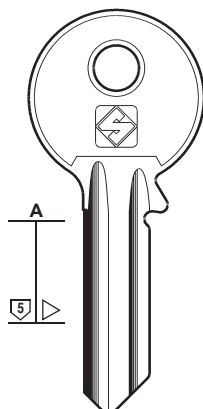

A
5

VI1
SPECIAL
 VI11R
 VI6
 VI12

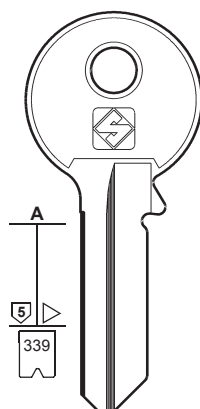

A
5
339

VI13
 VI23

VI080

VI081

VI9

VI9R

.....
0-1-2-3-4-5-6



206

PER / FOR

VIRO (IT)

- ABT
- ABUS
- BERAM
- BURG
- FAI
- ROYAL
- WEISSENFELS
- + ABLOY (5)
- + ELCA (76)
- + FAI (85)
- + TESA (182)

VIS (IT)

VISO (TW)

- FORT (90)
- YETI (218-219)

VISONIC (TW)

- ALPHA (16)

VJATKA (RU)

VÖGEL (CH)

- BAAL (28)

VOKO (DE)

- CES (47)
- DOM (70)
- JOWIL (110)

VOLGOGRAD (RU)

VOLKOVYSK (RU)

PER:
FOR:

VIRO

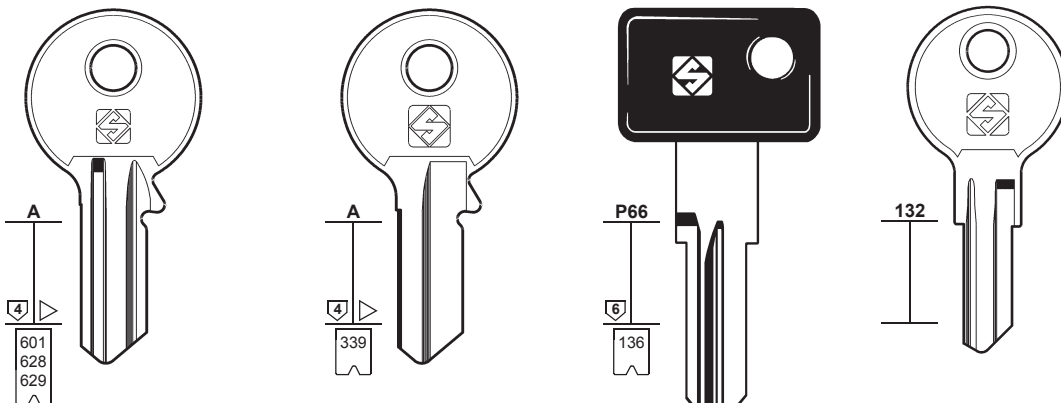

VI2



VI2R

0-1-2-3-4-5-6



VI10

0-1-2-3-4-5-6

0-1-2-3-4-5



VI10R

0-1-2-3-4-5



VI082



VI083

0-1-2-3-4-5-6



ZD10P

2001-3554
8001-9554



VI14

ABT

ABT



FAI

PER:
FOR:

VIRO

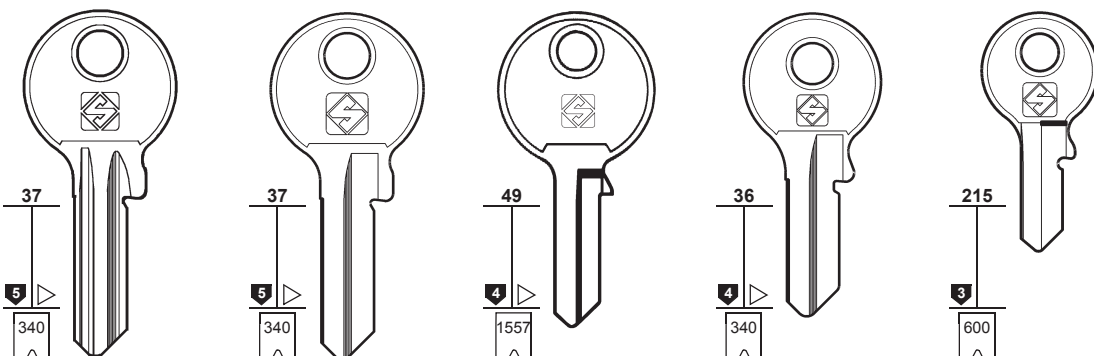

VI7

0-1-2-3-4-5



VI7R



VI086



VI087

0-1-2-3-4-5



VI4



VI4R

1-2-3-4-5



VI084



VI085

0-1-2-3-4-5



VI088



VI089

1-2-3



BERAM - ROYAL
WEISSENFELS



BERAM - ROYAL



ABUS - ROYAL



ABUS - BURG
mm 20

PER:
FOR:

VIS

VJATKA

VOLGOGRAD

VOLKOVYSK

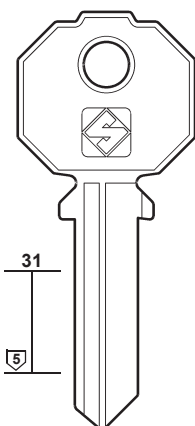

VS090V

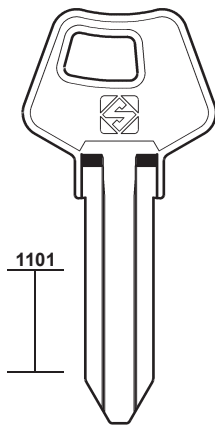

VK1

VK2

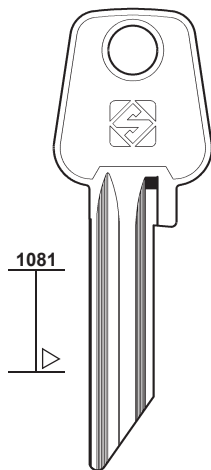

VLG1

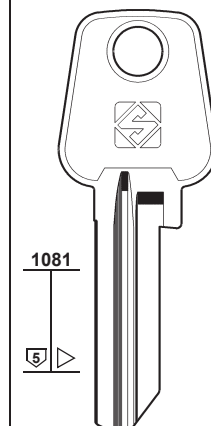

VLK1R

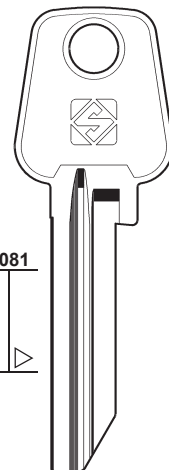

VLK2R

PER:
FOR: **VOUGA**

WALLY

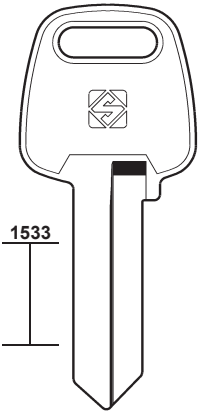

VOG1

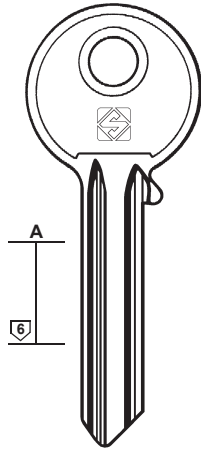
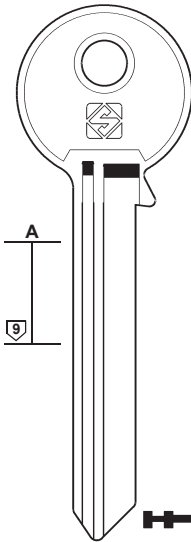

KK1

WA6

WA6R

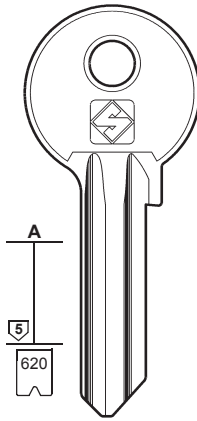

WA1

WA1R

1-2-3-4-5-6-7-8

MOREAUX

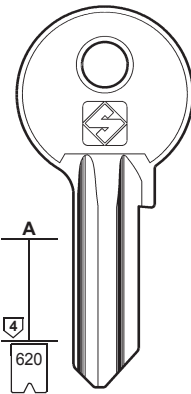

WA2

WA2R

1-2-3-4-5-6-7-8



207

PER / FOR

VOUGA (BR)

VS (DE)

JUNIE (111)

WALE (TW)

YALE (214)

WALLY (IT)

AKKA

MOREAUX

WANGGUAN (TW)

WANJIN (CN)

HOOPLY

WASA-IVANA (PL)

WASO (DE)

CES (47)

TRELOCK (188)

PER:
FOR:

WALLY

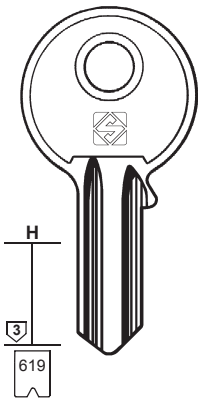

WA7

WA7R

1-2-3-4-5-6-7-8

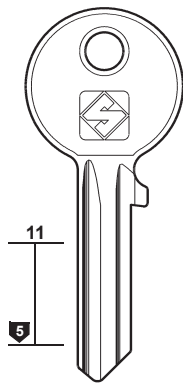

WA3

WA3R

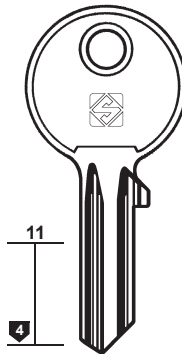

WA4

WA4R

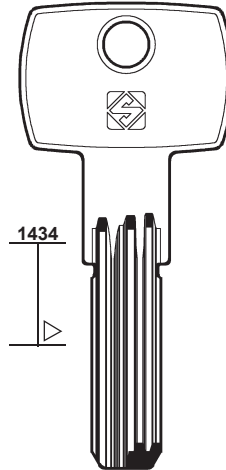

WA8



PER:
FOR:

WANGGUAN

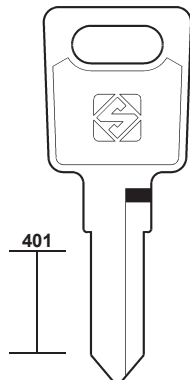

WGU1

WANJIN

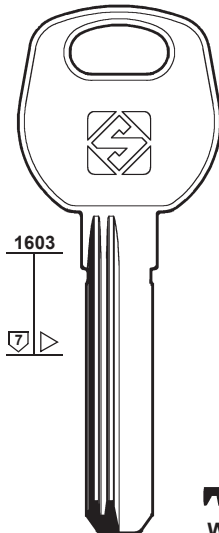

WJ1R



HOOPLY

WASA-IVANA

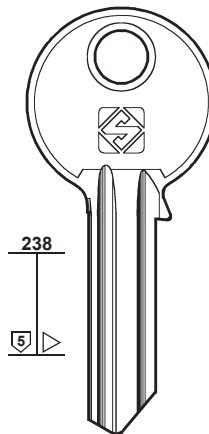

WSA1



208

PER / FOR

WAUS (PT)

WB (FR)

KKL (118)

WEBER (DE)

WECO

WEBSTER (GB)

WECO (DE)

CES (47)

WEBER (208)

YALE (213)

WEISER (US) (GB) (BE)

FALCON

FICHET

IDEAL-SECURITY

KAWE

+ FALCON (85)

WEISSENFELS (DE)

VIRO (206)

WELKA (IT)

+ YALE (212)

PER: **WAUS**

FOR:

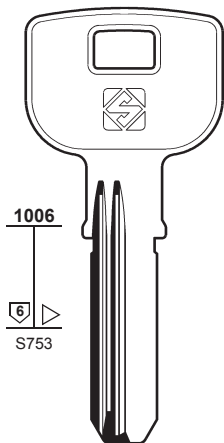

WU1R



PER: **WEBER**

FOR:

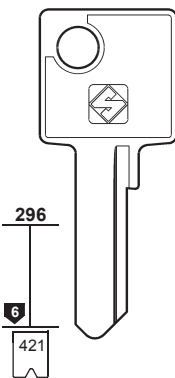

WEB1
... 1-594
A... 1-594

WEB3

WEB5

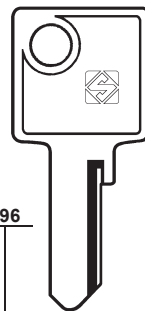

WEB2
... 1-594
A... 1-594

WEB4



PER: **WEBSTER**

FOR:

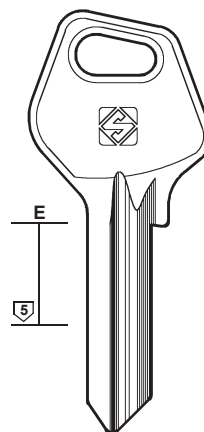

WTR1R

PER:

FOR:

WEISER

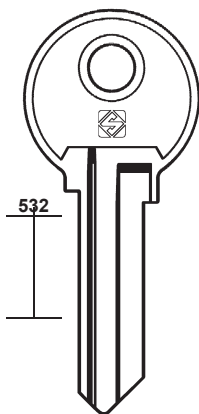

WEI3

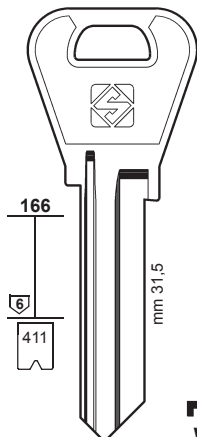

WEI9
..... 0-1-2-3-4-5-6-7-8-9
E..... 0-1-2-3-4-5-6-7-8-9

WEI2
..... 0-1-2-3-4-5-6-7-8-9
E..... 0-1-2-3-4-5-6-7-8-9

FICHET

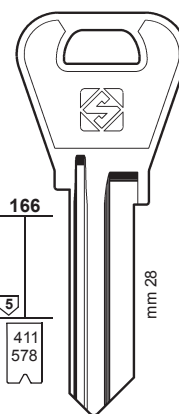

WEI8
E..... 0-1-2-3-4-5-6-7-8-9
E..... 0-1-2-3-4-5-6-7-8-9

WEI1
E..... 0-1-2-3-4-5-6-7-8-9
E..... 1-2-3-4-5-6-7-8-9
..... 0-1-2-3-4-5-6-7-8-9

KAWE

PER:

FOR:

WEISER

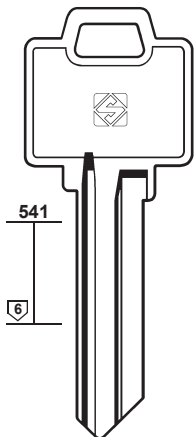

WEI4

FALCON

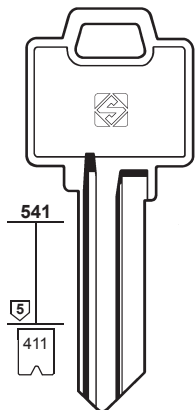

WEI5
E..... 0-1-2-3-4-5-6-7-8-9
..... 0-1-2-3-4-5-6-7-8-9

IDEAL-SECURITY

WELKA

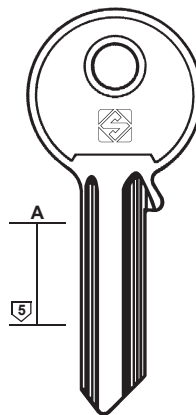

WE5 **WE5R**

WE16 **WE16R**

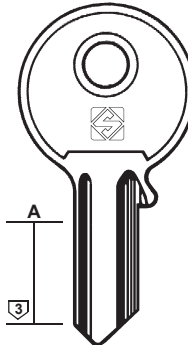

WE6 **WE6R**

WE1 **WE1R**

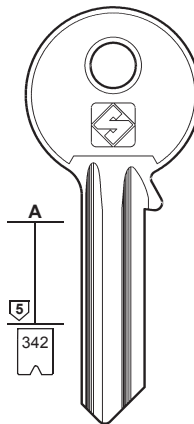

..... 12345 012345

WE16 **WE16R**

PER:
FOR:

WELKA

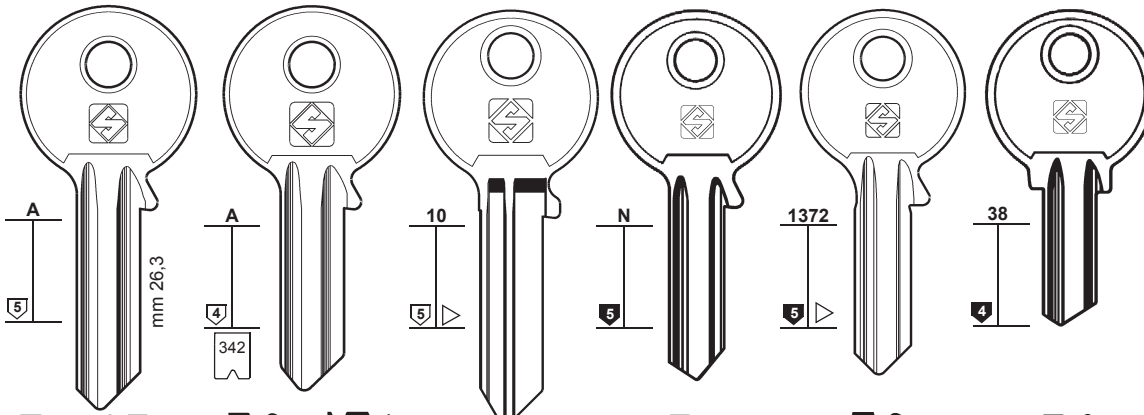

WE7 WE7R

WE2 WE2R
... 012345

WE3

WE12

WE4

WE14 WE14R

WE15 WE15

WE8

WE3R

WE12R

WE4R

WE13 WE13R



209

PER / FOR

WELKA (IT)
+ YALE (212)

WEPA (DE)
JOWIL (110)

WESCO (DE)
KIFERM (117)
LAS (121)

WESLOCK (US)

WEST (JP)

WFE (DE)

WHALE (IT)
GLOBE (97)

PER:
FOR:

WESLOCK

WEST

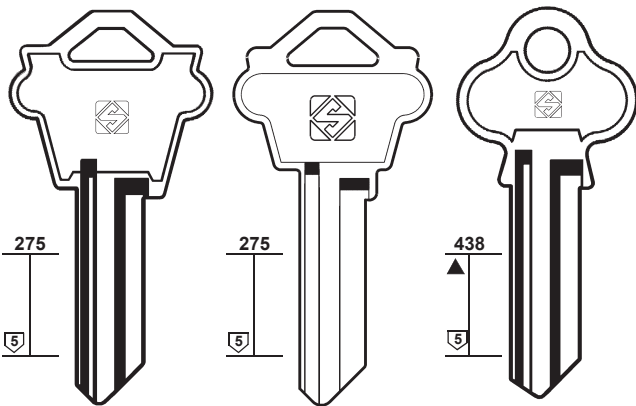

WS1

WS2

WS3

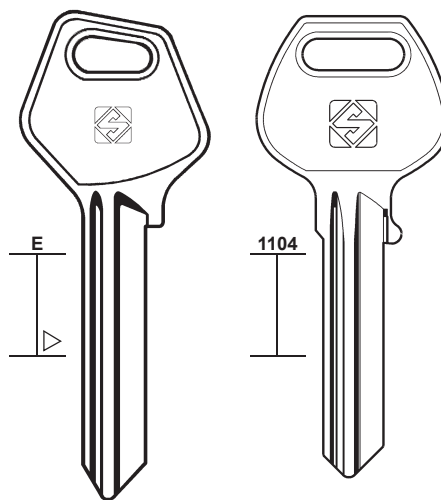

WST1

WST4

PER:
FOR:

WEST

WFE

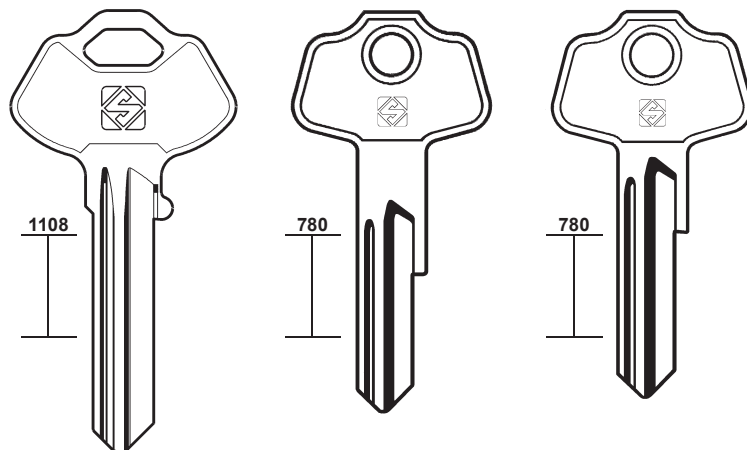

WST5

WST2

WST3

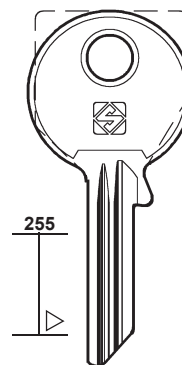

WFE1

WFE1R



210

PER / FOR

WHITCO (AU)

WIGRO (DE)

WILKA (210)

WILKA (DE)

CFP
DIERRE
DORMA
EMKA
GBS
JORE
TOP
VBH
WIGRO
+ BLASER (36)

PER:
FOR:

WHITCO

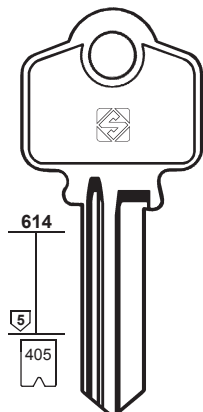

..... 0123456789A



WC1

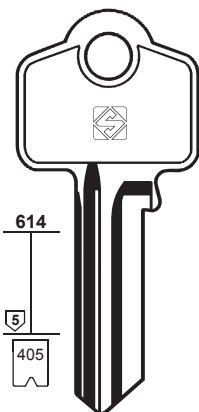

..... 0123456789A



WC2

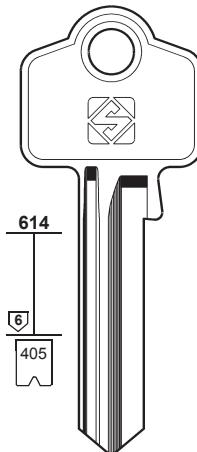

..... 0123456789A



WC3

PER:
FOR:

WILKA

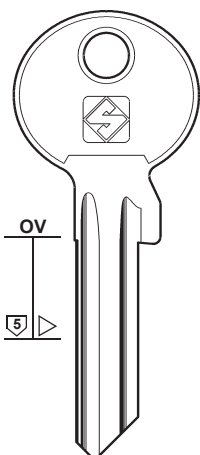

WK1X

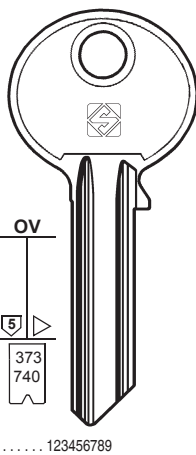

..... 123456789
..... 400001-430000



WK1

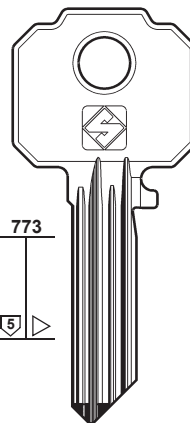

WK59R



WK49R



WK60R



WK50R



WK63R



WK51R

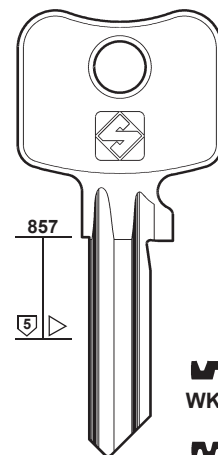

WK91R



WK69



WK68R

JORE - TOP - WIGRO

EMKA - DIERRE - DORMA - VBH

PER:
FOR:

WILKA

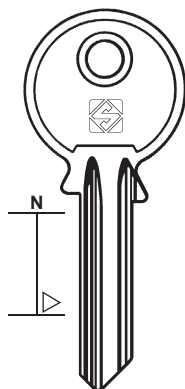

WK3

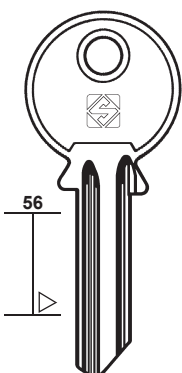

WK8



WK8R

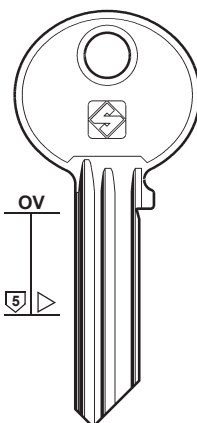

WK7



WK26



WK31



WK36



WK18



WK16



WK27



WK32



WK37



WK19



WK46



WK28



WK33



WK38



WK20



WK48



WK29



WK34



WK39



WK21



WK57



WK30



WK35



WK40



WK22



WK5

CFP - GBS

PER:
FOR:

WILKA

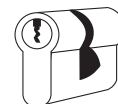
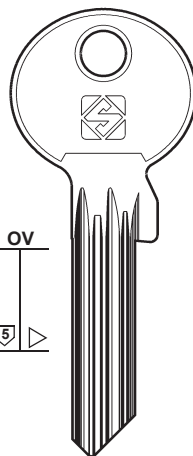
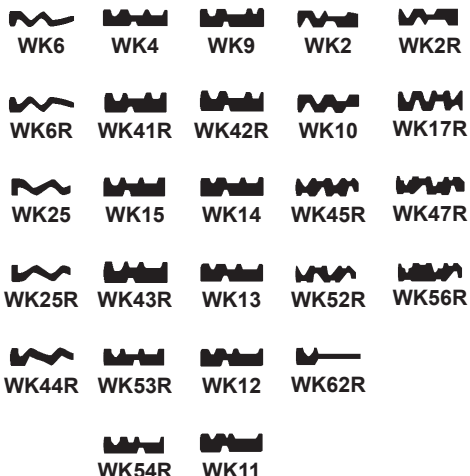
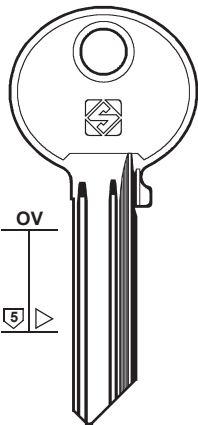

211

PER / FOR

WILKA (DE)
+ **BLASER** (36)

WILLACH (DE)
 HUWIL (104)

WILLENHALL (GB)
 GIBBONS (96)

WILSON BOHANNON (US)
VENLOCK

WINFIELD (TW)
 YETI (218-219)

WINFOR (GB)
 MERONI (137)

WINKHAUS (DE)
 TOK-WINKHAUS
(184-185-186-187)

WINLOCK (GB)

WINNER (FR)
 GABON (93)

WIREROPE (HK)

W.M.S. (GB)
I.R.
TITUS
+ **AVOCET** (26)

WOC (FR)
 YALE (212)

PER:
FOR:

WILKA

WILSON BOHANNON

WINLOCK

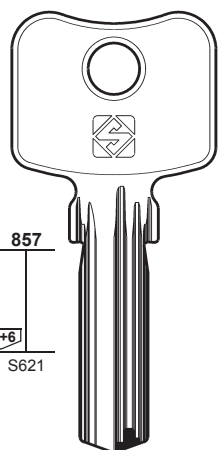

WK70
.....
10001-43000

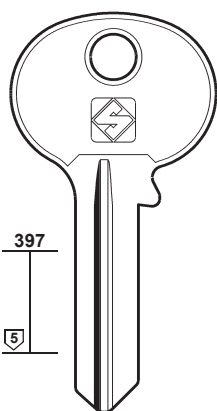

WH1

VENLOCK

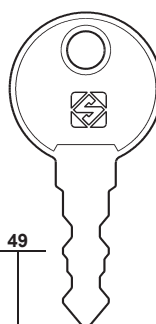

WLC1



PER:
FOR:

WIREROPE

W.M.S.

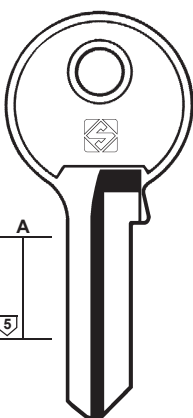

WR1

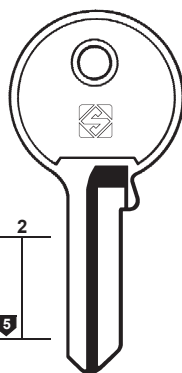

WR2

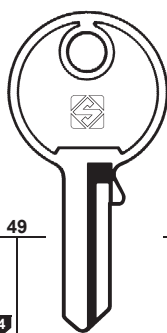

WR3

WR4

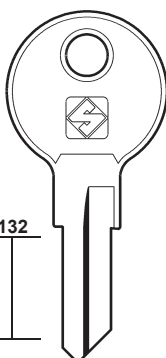

WR5R

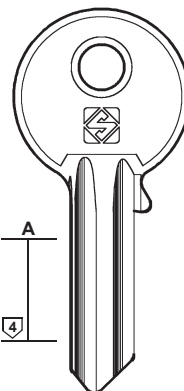

WMS1

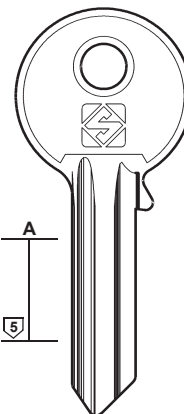

WMS2



I.R. - TITUS



212

PER / FOR

WS (DE)

WÜRTH (DE)

✪ CORBIN (60)

✪ HUWIL (104)

XIEHE (CN)

YAC (FR)

✪ RONIS (161)

YALE (DE) (GB) (US)

BIRD

BKS

CARAT

CKS

KALE

LAREDO

PRIVE

ROC

UMF

WELKA

WOC

+ ✪ BKS (34-35)

+ ✪ HTV (103)

+ ✪ URBIS (197)

PER: WS

FOR:

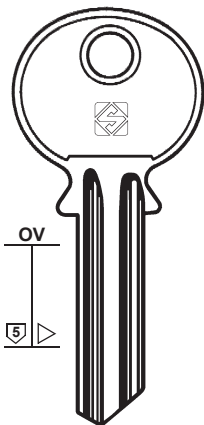

PER: XIEHE

FOR:

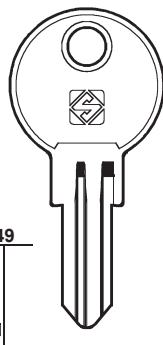

PER: YALE

FOR:

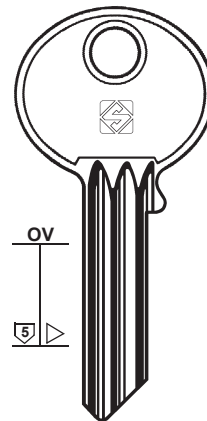
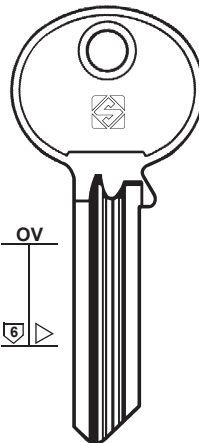

DE GB

DE GB

PER: YALE

FOR:

PER: YALE

FOR:

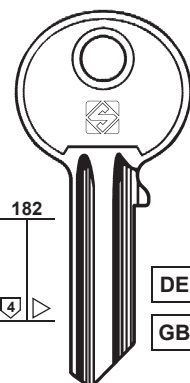
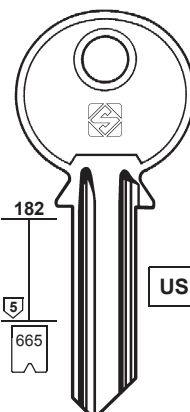
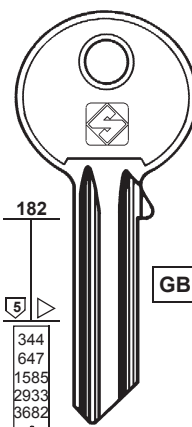
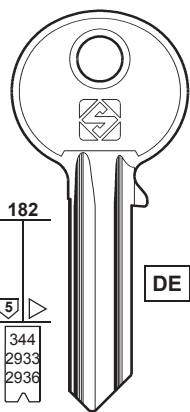
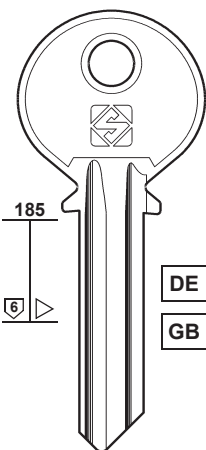

..... 01234567
..... 0123456789
..... 01234567890ABCDEFGHIJL

..... 01234567
..... 0123456789
..... 01234567890ABCDEFGHIJL

..... 01234567

BIRD - BKS - CARAT
CKS - KALE - LAREDO
ROC - WELKA - WOC

PRIVE

UMF

PER: YALE

FOR:

PER: YALE

FOR:

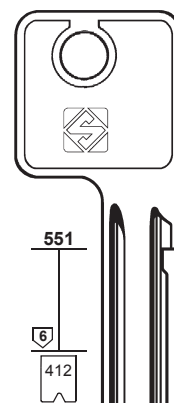
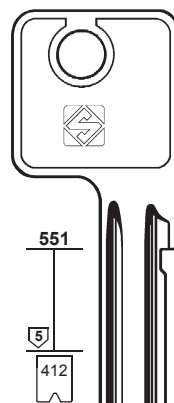
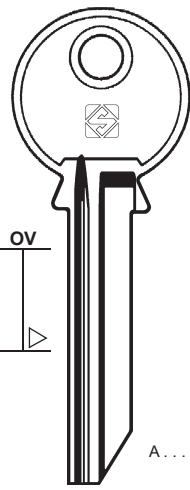
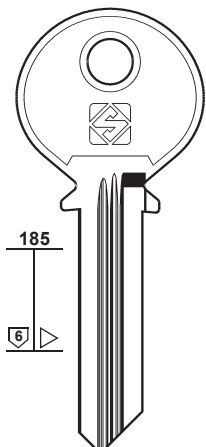
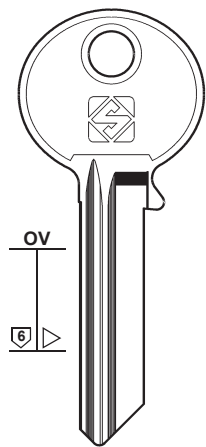

A 0123456789
..... 0123456789
..... 0123456789

..... 0123456789
A 0123456789
..... 0123456789
..... 0123456789



..... 0123456789
A 0123456789

US

PER:
FOR:

YALE

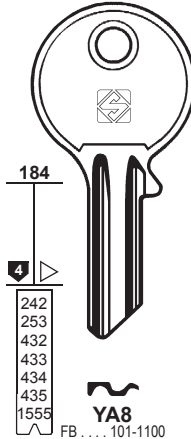
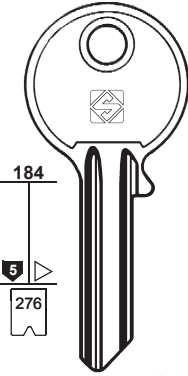
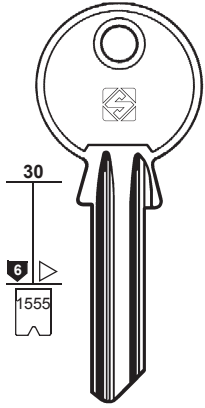

YA8E
 BM...1-1000
 KA...1-1000
 KB...1-1024
 AT...1-1040
 A...1-1100
 DB...1-1100
 ...1-1600
 B...1-1600
 BS...1-1600
 D...1-1600
 E...1-1600
 F...1-1600
 IC...1-1600
 J...1-1600
 JA...1-1600
 JB...1-1600
 JD...1-1600
 KV...1-20025
 KD...1-4950
 ABS...1-6000
 D...1-750
 R...10-101
 KA...1001-2000
 FB...101-1100
 FP...101-1100
 R...101-160
 MC...101-850

YA21
 TBS ... (AB) 401-450
 SC ... (AB) 101-150

YA24
 TBS ... (BC) 551-600

YA22
 SC ... 1-50
 TBS ... (AC) 451-500

YA25
 SC ... (BC) 201-250
 TBS ... (BD) 601-650

YA23
 SC ... (AD) 51-100
 TBS ... (AD) 501-500

YA26
 SC ... (CD) 151-200
 TBS ... (CD) 651-700

YA15
 SX ... 1-1000
 VR ... 1-4000
 BX ... 1-500
 VW ... 1-4000

YA15R

YA8ER
 DE GB BKS - WECO

YA30
 ABS ...
 7537-8336

YA30R

YA8
 FB ... 101-1100
 FP ... 101-1100
 R ... 101-160
 MC ... 101-850

YA8R
 SUREX

RP ... 1001-3400

YA32 **YA32R**

YA3 **YA3R**



213

PER / FOR

YALE (DE) (GB) (US)
 ABUS
 BENDIX
 BKS
 CAB
 CHICAGO
 COLE-HERSEE
 HUDSON
 SOUTHC
 SUREX
 WECO
 + BKS (34-35)
 + HTV (103)
 + URBIS (197)

PER:
FOR:

YALE

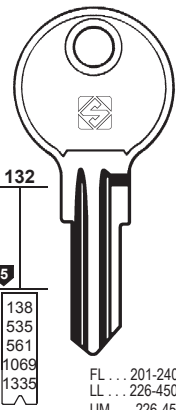
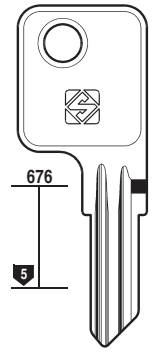
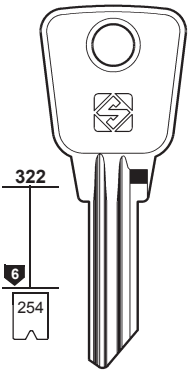
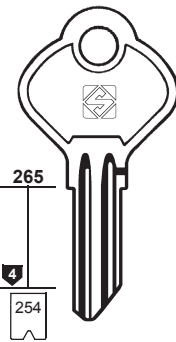

YA66 **YA66R**
 ... F8 1001-2500
 ... F9 1001-2500

YA68 **YA68R**

YA69 **YA69R**

YA20 **YA20R**

YA19 **YA19R**
 LT ... 1-100
 LC ... 1-100

YA65 **YA65R**

FL ... 201-240
 LL ... 226-450
 UM ... 226-450
 ... 500-550
 ... 600-650

YA18 **YA18R**
 SOUTHCO

YA17 **YA17R**

DC ... 551-952
 TOK ... 1-99
 RS ... T 1-99

YA4 **YA4R**
 HC ... 001-202
 KC ... 251-500
 CH ... 251-750



ABUS - BENDIX - CAB - CHICAGO
 COLE-HERSEE - HUDSON

PER:
FOR:

YALE

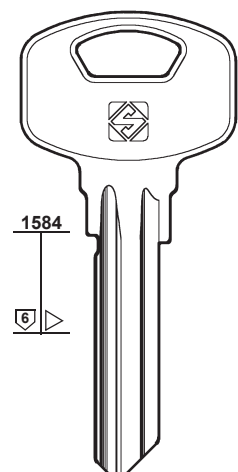
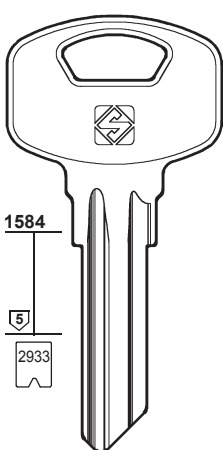
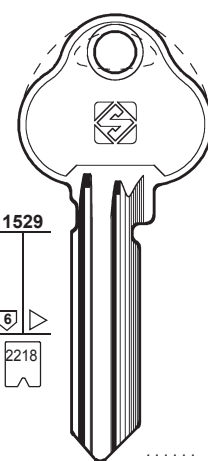
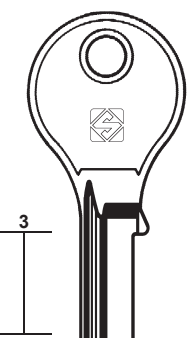
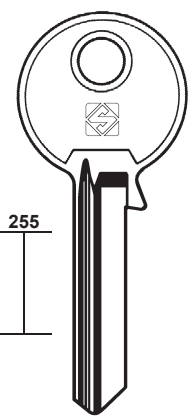

YA16L **YA16RL**

YA16 **YA16R**

YA88
 X5

YA89

YA91





214

PER / FOR

YALE (IT) (GB)
FERCO
WALE

- + BKS (34-35)
- + HTV (103)
- + URBIS (197)

PER:
FOR:

YALE

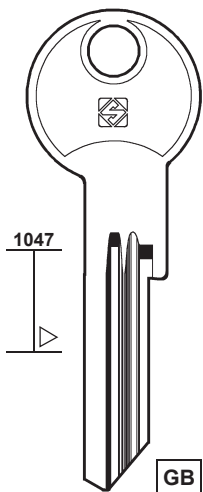

YA98R

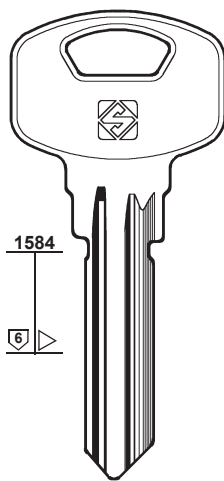

YA93

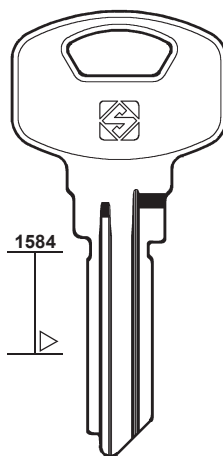

YA87
KTM

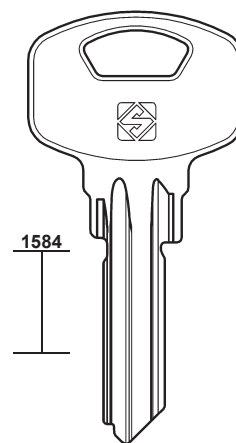

YA100

PER:
FOR:

YALE

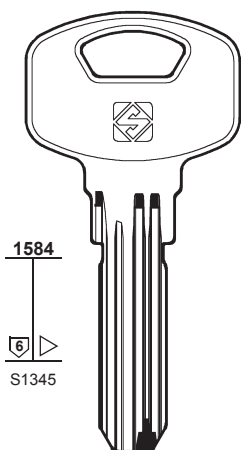

YA94
"1000 Series"

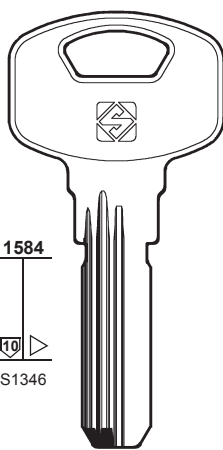

YA95R
"2000 Series"

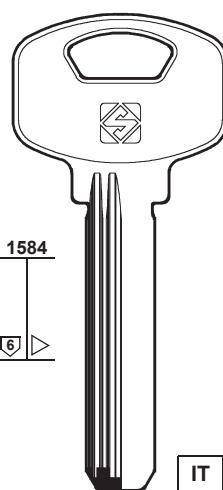

YA99R

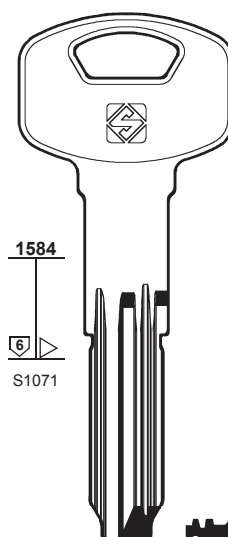

YA90

PER:
FOR:

YALE (IT)

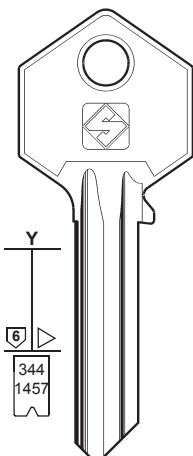

YA31 YA31R

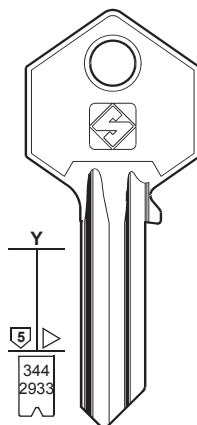

YA63
YA226 YA227

- YA42 12
- YA43 13
- YA44 14
- YA45 15
- YA46 16
- YA47 17
- YA48 18
- YA49 19
- YA50 20
- YA51 21

- 22 YA52
- 23 YA53
- 24 YA54
- 25 YA55
- 26 YA56
- 27 YA57
- 28 YA58
- 29 YA59
- 30 YA60
- 31 YA61
- 32 YA62



..... 0123456789
..... 01234567890ABCDEFGHIJL

FERCO - WALE

Copyright by Silca S.p.A. 2018 - All Rights Reserved

PER:
FOR:

YALE (IT)



215

PER / FOR

YALE (IT) (US)
SOS
WALE
+ BKS (34-35)
+ HTV (103)
+ URBIS (197)

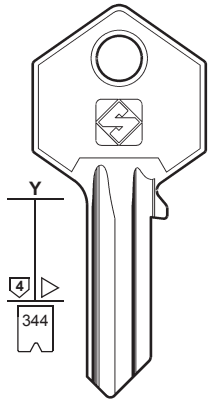

..... 0-1-2-3-4-5-6-7-8-9



YA6R



YA6

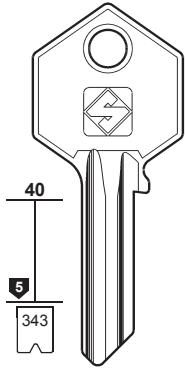

..... 1-2-3-4-5-6-7-8



YA7



YA7R



SOS - WALE

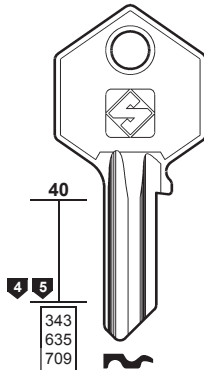

..... 1-2-3-4-5-6-7-8

YA13

..... 1-2-3-4
..... 0-1-2-3-4-5



YA13R

..... 0-1-2-3-4-5-6-7-8



WALE

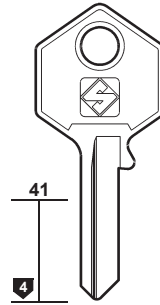

YA14 YA14R



MIGNON

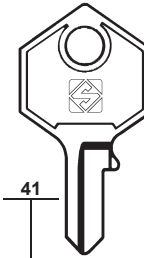

YA33 YA33R



MIGNON

PER:
FOR:

YALE (IT)

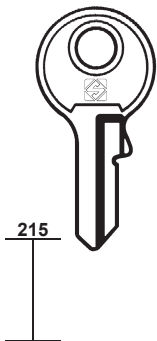

YA74

YA74R



MIGNON

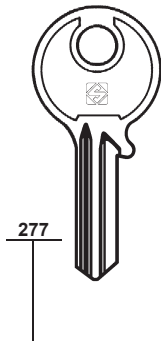

CS28

CS28R

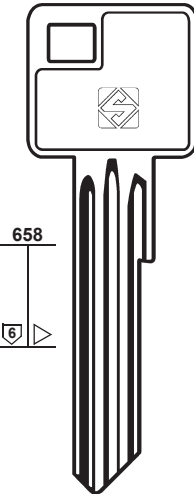

YA39

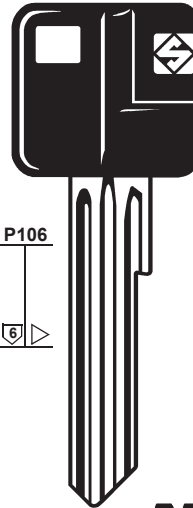

YA39P

PER:
FOR:

YALE

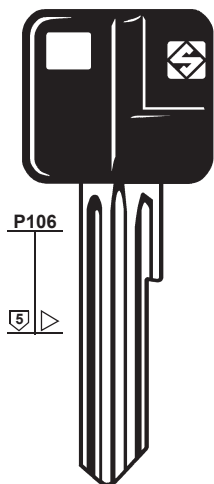

YA40P

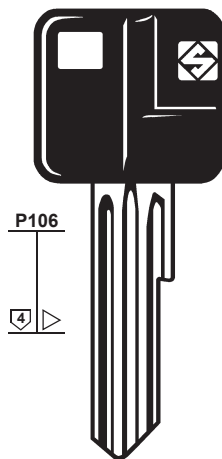

YA73P

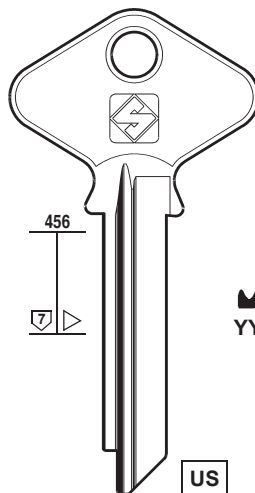

YYP7R

US

YYA7

YYB7

YYC7

YYD7

YYE7

YYF7

YYG7

YYH7

YYK7



216

PER / FOR

YALE (DE) (GB) (US)
+ BKS (34-35)
+ HTV (103)
+ URBIS (197)

PER:
FOR:

YALE (US)

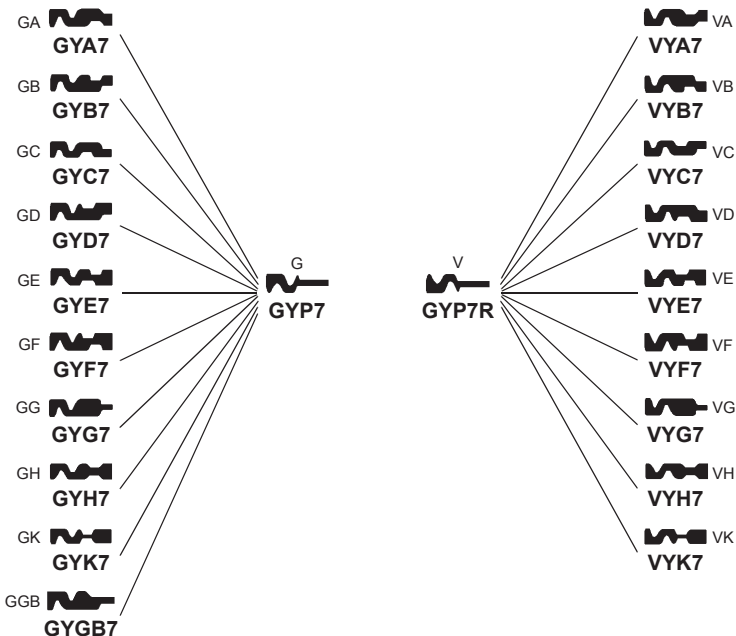
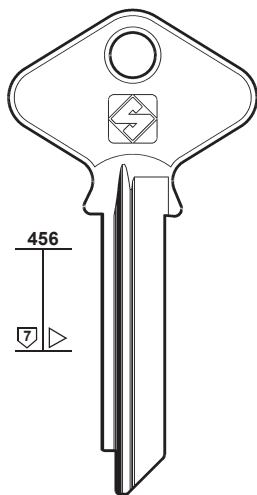

PER:
FOR:

YALE (US)

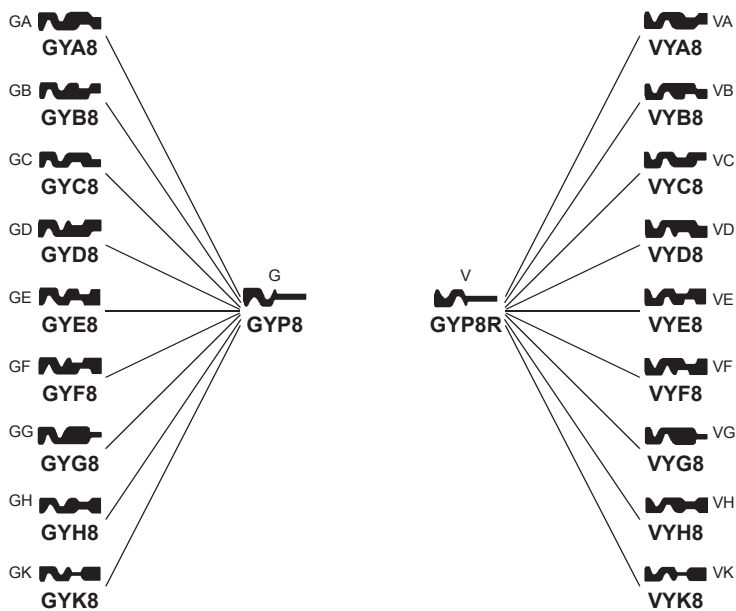
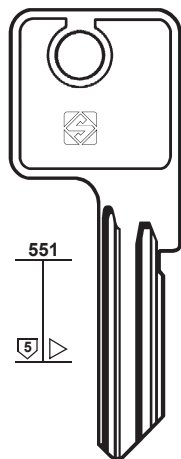

PER:
FOR:

YALE (DE) (GB)

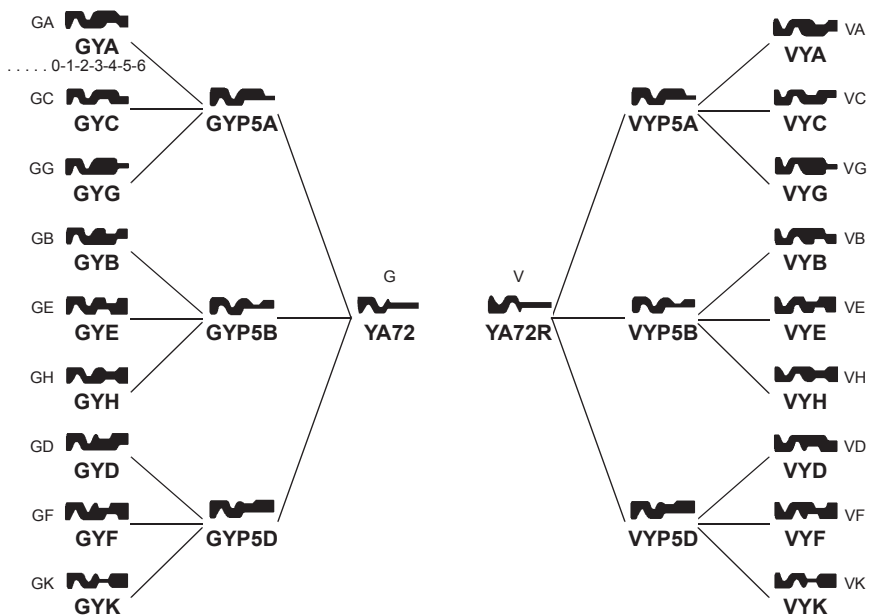
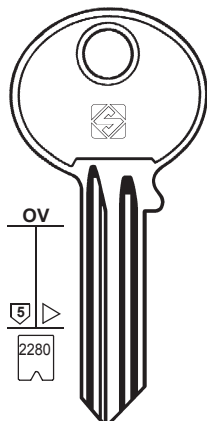

PER:
FOR:

YALE (DE) (GB)



217

PER / FOR

YALE (DE) (GB)
+ BKS (34-35)
+ HTV (103)
+ URBIS (197)

YALTRES (AR)
+ FTH (92)

YANEDIS (GB)
+ ETAS (78)

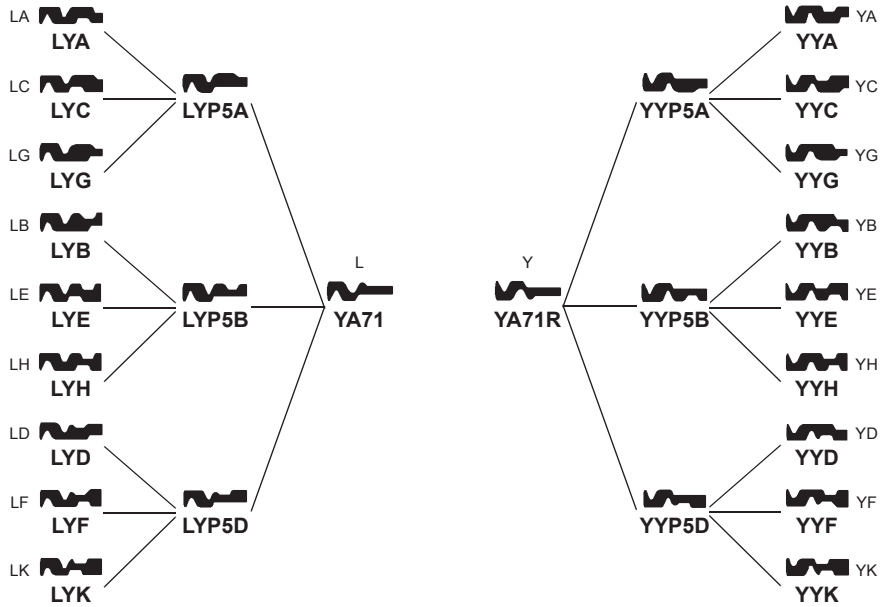
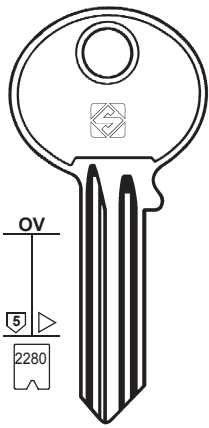

PER:
FOR:

YALE (DE) (GB)

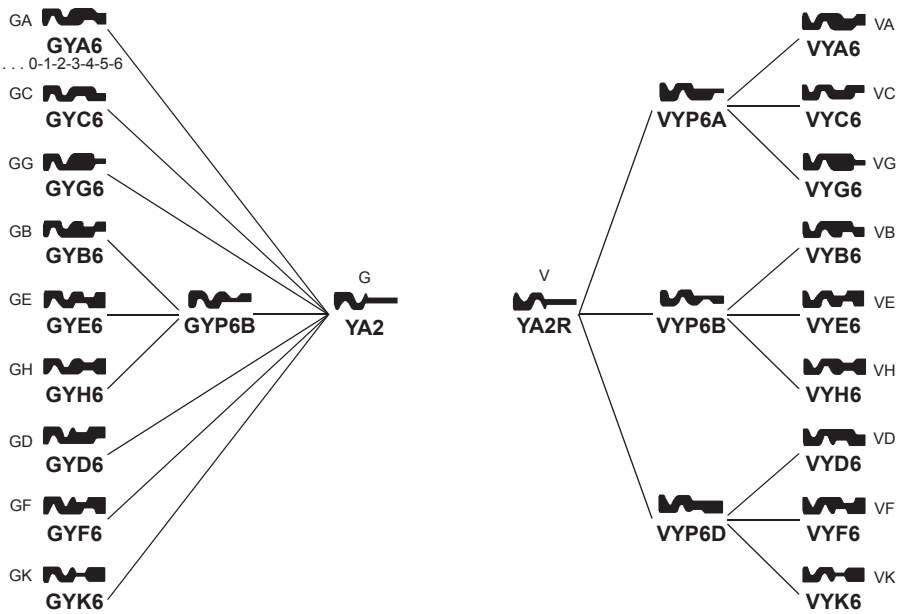
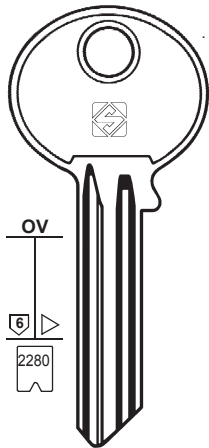

PER:
FOR:

YALE (DE) (GB)

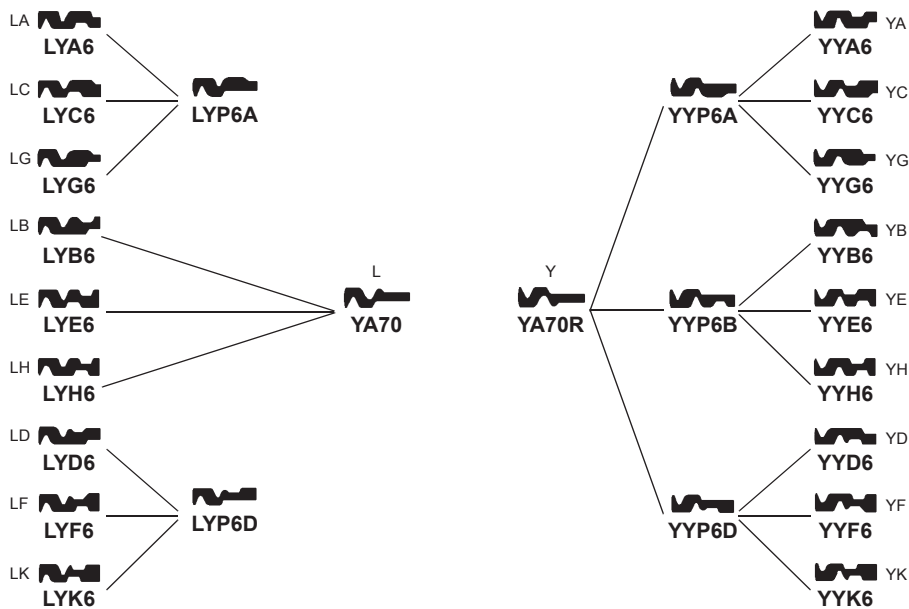
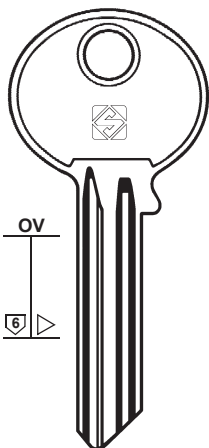



218

PER / FOR

YANMAR (JP)

YARDENI (IL)

YEMAR (ES)

UCEM (192)

YETI (PL)

FAB (82)

LOB (126)

MCM (134)

YETI (TW)

AKIRA
 ASIA
 BEDI
 BELL
 DEHA
 FOUR-CIRCLE
 HAIDE
 HEAD
 HEMY
 HERMES
 LOTUS
 RAM
 ROYAL
 SANCHUN
 SEZAN
 SWAN
 VELO
 VISO
 WINFIELD

PER: YANMAR

FOR: YANMAR

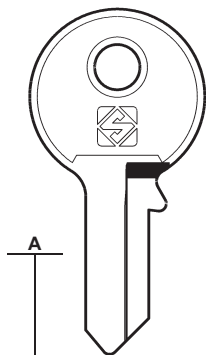

YAR1

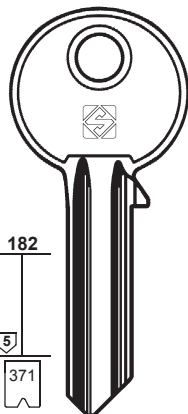

YD1



YD12



YD1R

..... 0-1-2-3-4-5-6-7-8-9

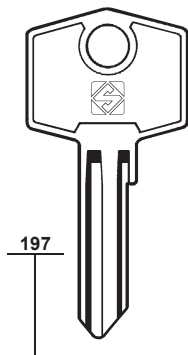

YD2



YD2R

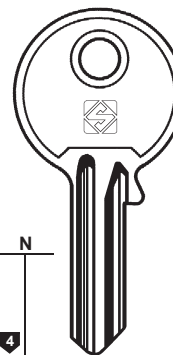

YD4



YD4R

..... 1-2-3-4-5-6

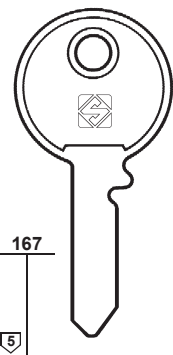

YD5R



PER: YARDENI

FOR: YARDENI

YARDENI

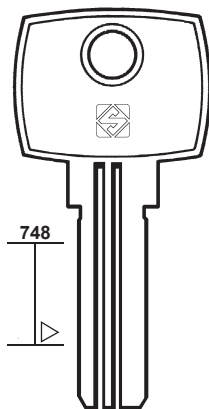

YD3R

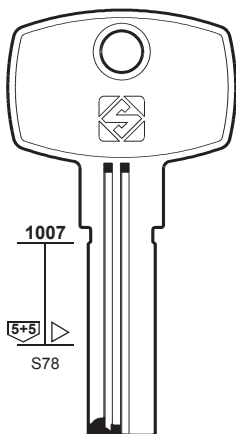

YD6R

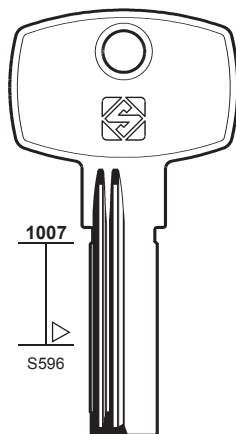

YD7R

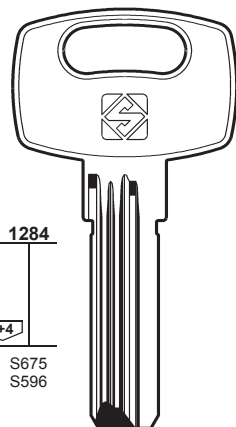

YD13R

XL



YD14R

6

PER: YETI

FOR: YETI

YETI

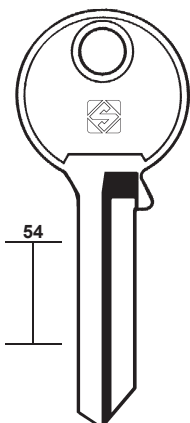

YT6



YT6R

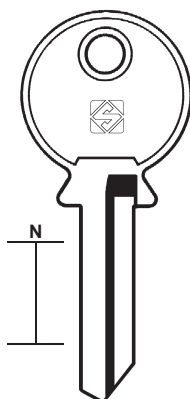

YT7



YT7R

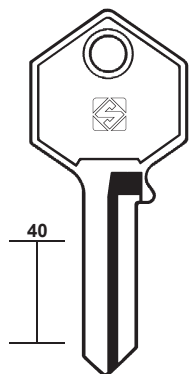

YT8



YT8R

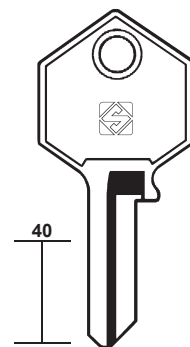

YT1



YT1R



YT12



YT12R



YT13



YT13R



YT14



YT14R



YT3



YT3R

AKIRA - ASIA - BEDI - BELL - DEHA
 FOUR-CIRCLE - HAIDE - HEMY - HERMES
 HEAD - LOTUS - RAM - ROYAL - SANCHUN
 SEZAN - SWAN - VELO - VISO - WINFIELD



mm 40

PER:
FOR:

YETI

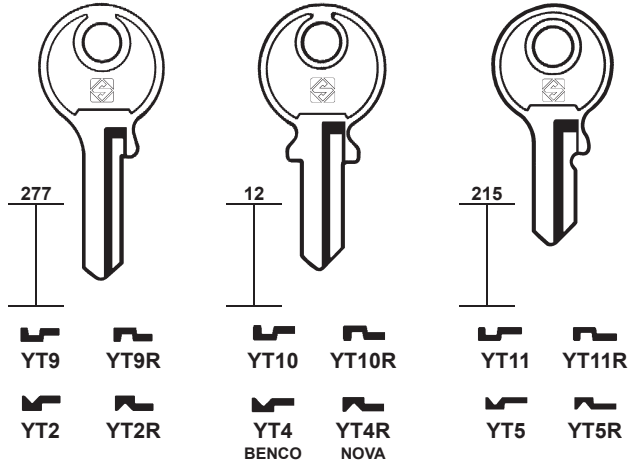

AKIRA - ASIA - BEDI - BELL - DEHA - FOUR-CIRCLE
HAIDE - HEMY - HERMES - HEAD - LOTUS - RAM - ROYAL
SANCHUN - SEZAN - SWAN - VELO - VISO - WINFIELD

YUN HUAN

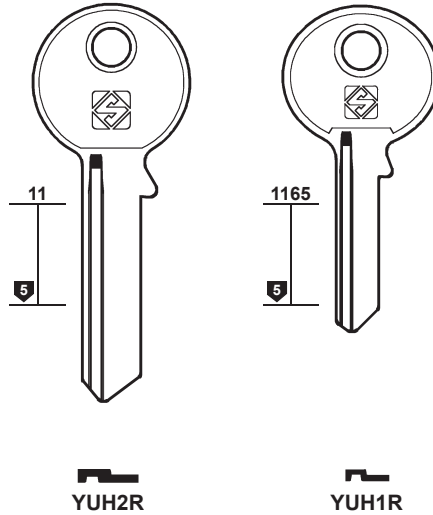

219

PER / FOR

YETI (TW)
AKIRA
ASIA
BEDI
BELL
BENCO
DEHA
FOUR-CIRCLE
HAIDE
HEAD
HEMY
HERMES
LOTUS
NOVA
RAM
ROYAL
SANCHUN
SEZAN
SWAN
VELO
VISO
WINFIELD

YONGTAI (TW)
TRI-CIRCLE (190)

YUN HUAN (CN)

YVEL (FR)
RICOUARD (160)

ZADI (IT)
BRETER (38)

PER:
FOR:

ZADI (IT)

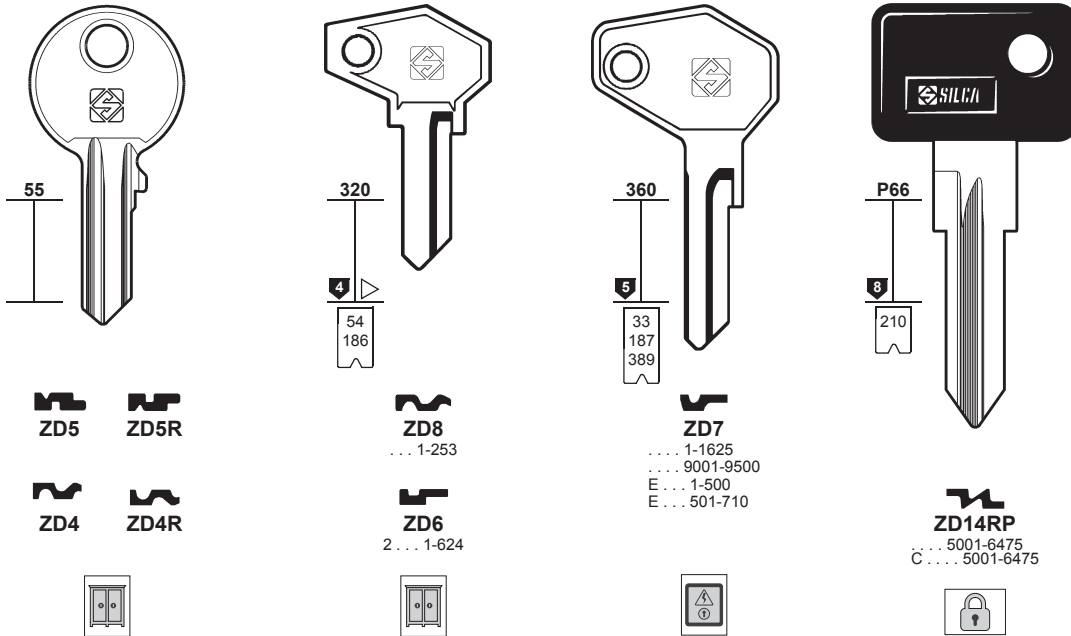

PER:
FOR:

ZADI (IT)

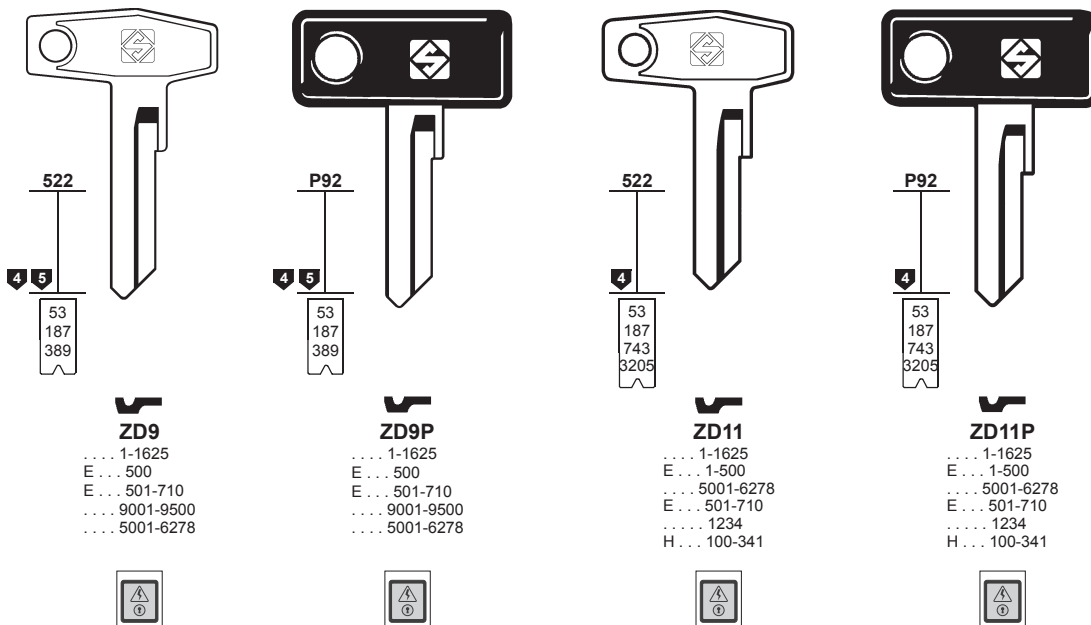



220

PER / FOR

ZADI (IT)
BULLOCK
+ BRETER (38)

ZANETTI A. (IT)
GHIDINI
OB
ROLEX
TAUB
TOR

ZANI (IT)
BALLY
FIC
SINA
ZETA
+ ICSA (105)
+ MORI E. (142)

ŽEČE (HR)
 CORBIN (60)

ZEISS IKON (DE)
BRUMME
OTIS
+ BAB (28)
+ CORONA (63)

PER: ZADI

FOR:

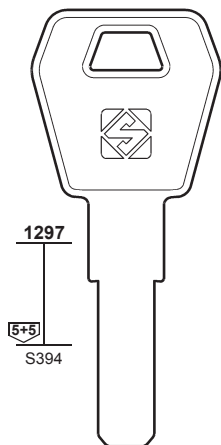

1297
5+5
S394



ZD25



BULLOCK

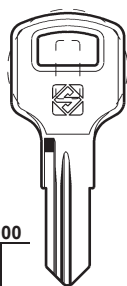

1000



ZD26R

ZANETTI ANGELO

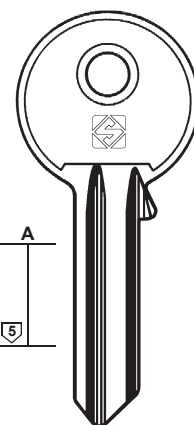

A
5



ZA2R

GHIDINI - OB - ROLEX - TAUB - TOR

PER: ZANI

FOR:

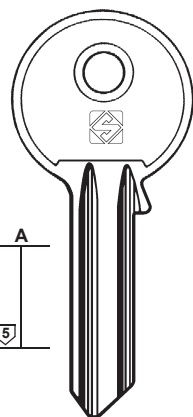

A
5



ZI1



ZI1R

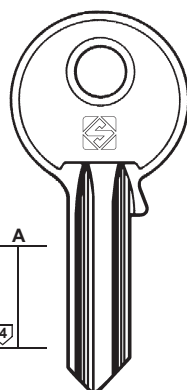

A
4



ZI2



ZI2R

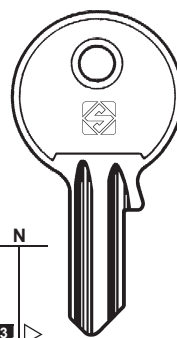

N
3



ZI3



ZI3R

BALLY - FIC - SINA - ZETA

BALLY

ZEISS IKON

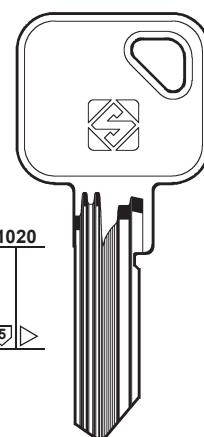

1020
5



ZE45

PER: ZEISS IKON

FOR:

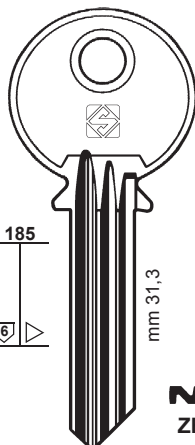

185
6

mm 31,3



ZE42



ZE14
ZC



ZE14R
ZA



ZE11
ZD



ZE11R
ZB

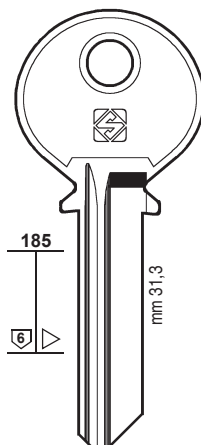

185
6

mm 31,3



ZE46



ZE46R

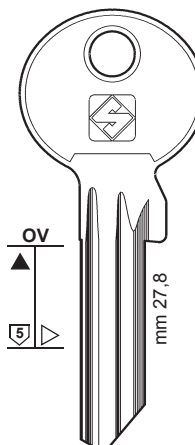

OV
5

mm 27,8



ZE34X
SN1



ZE34RX
SN2



ZE39X
SN3



ZE39RX
SN4



ZE40X
SN5



ZE1X
N1



ZE1RX
N2



BRUMME - OTIS

PER:
FOR:

ZEISS IKON



221

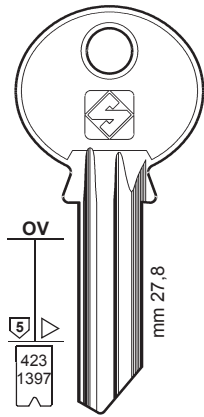

- | | |
|----------------------|----------------------|
| ZE15
Z 461 | ZE16
Z 484 |
| ZE13
ZC | ZE13R
ZA |
| ZE10
ZD | ZE10R
ZB |
| ZE34
SN1 | ZE34R
SN2 |
| ZE39
SN3 | ZE39R
SN4 |
| ZE1
N1 | ZE1R
N2 |
- (TK5)
1-2-3-4-5-6-7-8-9-0
A-B-C-D-E-F-G-H-I-L
- (TK6)
1-2-3-4-5-6-7-8-9-0
A-B-C-D-E-F-G-H-I-L

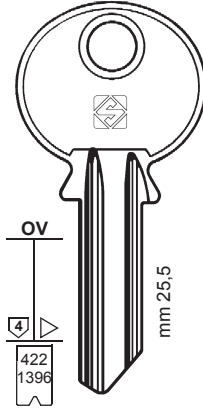

- ZE2**
N 11
- (SK5)
1-2-3-4-5-6-7-8-9-0
A-B-C-D-E-F-G-H-I-L

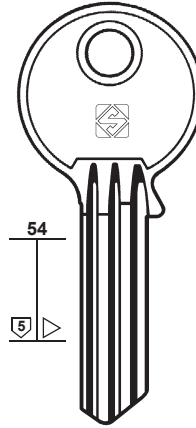

- ZE12**
M

BRUMME - OTIS

BURG

PER / FOR

- ZEISS IKON (DE)**
BRUMME
BURG
CORONA
FORTSCHRITT
OTIS
+ BAB (28)
+ CORONA (63)

PER:
FOR:

ZEISS IKON

ZENI (GB)

ZENICA (FR)

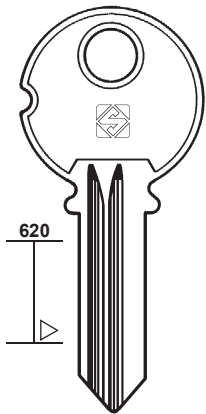

- ZE30**
DS2
- ZE30R**
DS1

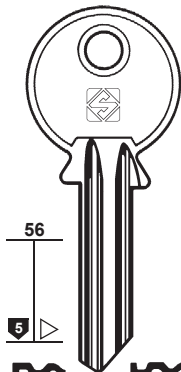

- ZE5**
K5
- ZE4**
K3
- ZE3**
K1
- ZE5R**
K60
- ZE3R**
K2

CORONA
FORTSCHRITT

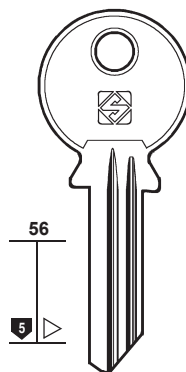

- ZE58**

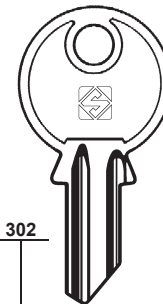

- ZE7**



PER:
FOR:

ZENI

ZENICA

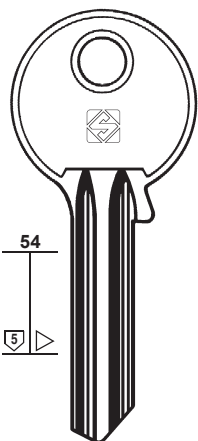

- ZN1**

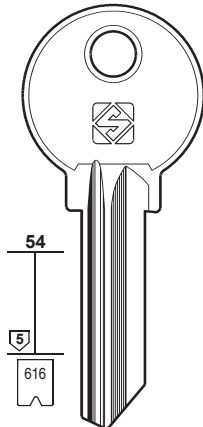

- CA14**
- CA8**
.....
170000-176310
..... 0123456

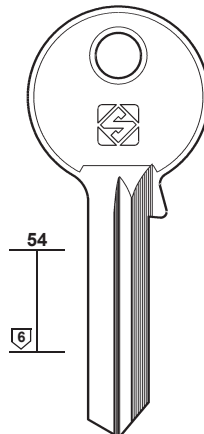

- CA13**

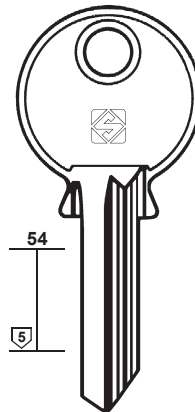

- CA12**

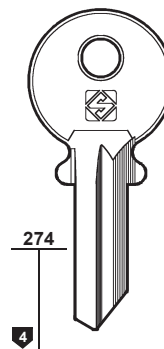

- CA6**



222

PER / FOR

ZENITH (FR) (IT)
 ARNOV
 AUBERT
 FO
 MONOBLOC
 QCP
 SIAM
 SICMA
 + CITY (58)
 + SIS (170)

ZETA (IT)
 ZANI (220)

ZHONGHENG (TW)

ZOO (GB)

PER:
 FOR:

ZENITH (FR)

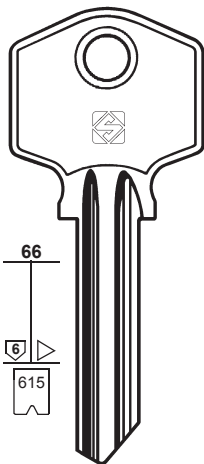

CA11

..... 0123456

..... 400001-435886

AUBERT - FO

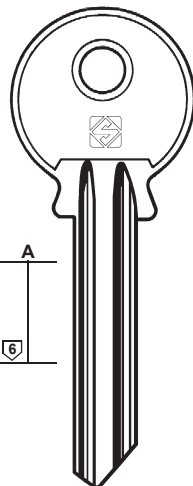

CA11R



CA10



CA10R

ARNOV
FO - MONOBLOC

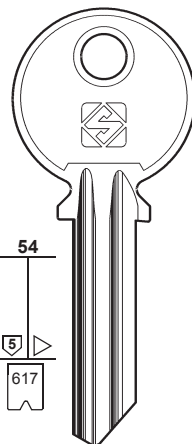

CA15

..... 81000-88179

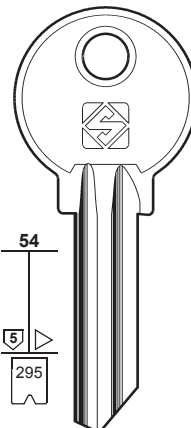

CA2R



CA2

160 ... 000-999

16 ... 1000-6288

QCP - SIAM

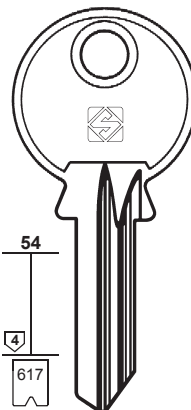

CA7

..... 0-1-2-3-4-5-6

..... 12500-15949

SICMA

PER:
 FOR:

ZHONGHENG

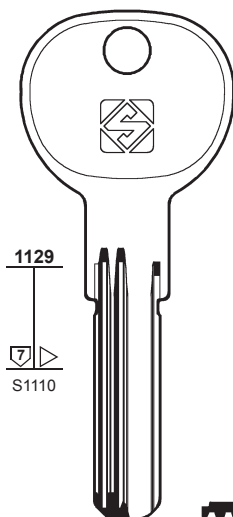

ZH1R



ZOO

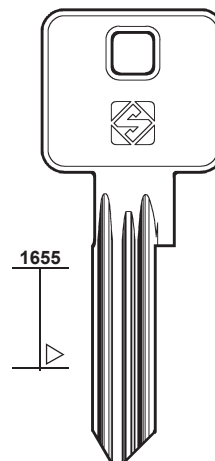

ZO1

PER:
 FOR:



Dimple keys
Chiavi punzonate
Bohrmuldenschlüssel
Clés à points
Llaves de seguridad
Chaves de pontos

PER:
FOR: **3M**

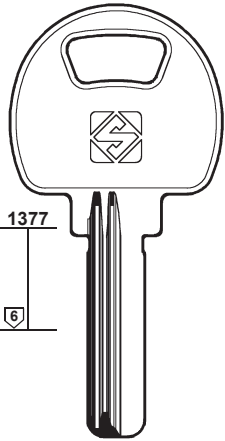

TRM1R

ABUS

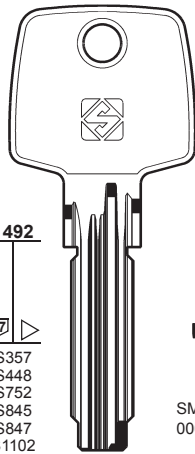

6+7

S357
S448
S752
S845
S847
S1102



AB84

EC550

SM
00001-30000

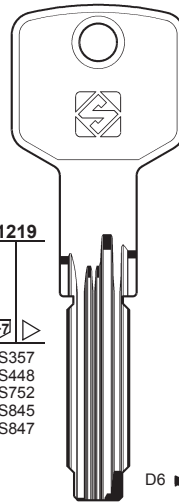

1219

6+7

S357
S448
S752
S845
S847



AB48

..... 00001-38832
..... 0001-4800
..... (XN005710)1-38832
..... 000001-168000



AB74

..... 00001-38832
..... 0001-4800
..... (XN005710)1-38832
..... 000001-168000



AB77

NEW ASTRAL

PER:
FOR: **ABUS**

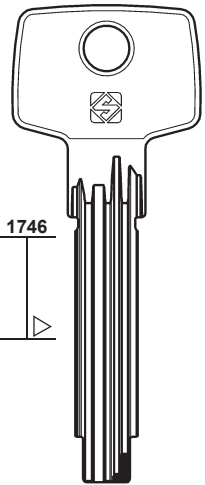

1746

AB109

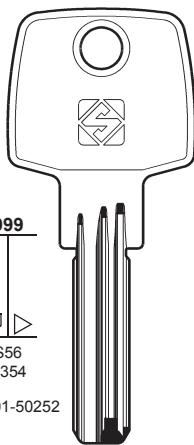

999

10

S56
S354

- 00001-50252

AB40

AAL

EXTRA-CLASSE

CISA - BRICARD

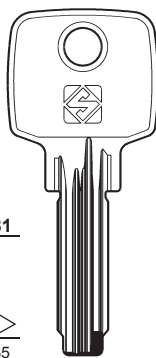

1481

5

S635
S846

..... 00001-10000
D8 0000-9999

AB62

EC75

mm 30-40-50

AGA

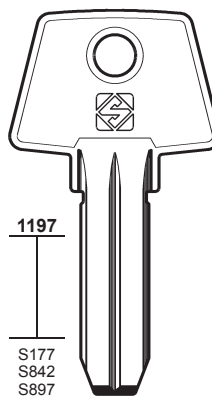

1197

S177
S842
S897
S898
S972

..... 1-2-3-4-5

AGA7

COLOMENCA - FB
SERRALLER - TERCA

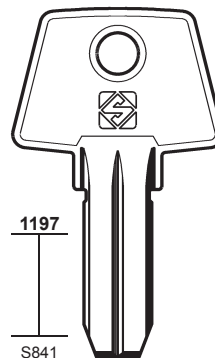

1197

S841
S895
S896

AGA9

CASAS

PER:
FOR: **AGB**

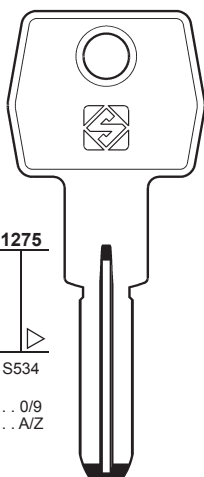

1275

9

S534

..... 0/9
..... A/Z

AGB5

SCUDO 9000

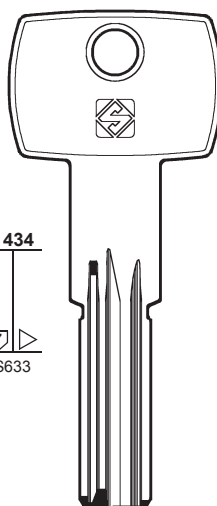

1434

7

S633

AGB8

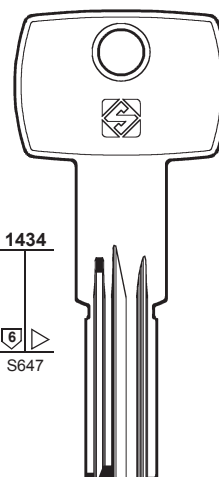

1434

6

S647

AGB9



225

PER / FOR

3M (CN)

ABUS (DE)

BRICARD

CISA

+ CISA (229)

AGA (ES)

CASAS

COLOMENCA

FB

SERRALLER

TERCA

AGB (IT)



226

PER / FOR

AGB (IT)

AGENT (JP)

ALA (IT)

KESO (238)

AL AHRAM (EG)

ALPHA (IT)

AMIG (ES)

APEKS (RU)

ATRA (IT)

ISEO (237)

PER: **AGB**
FOR:

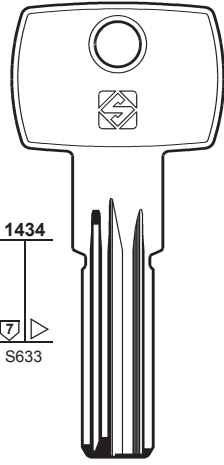

AGB6
SCUDO 7000

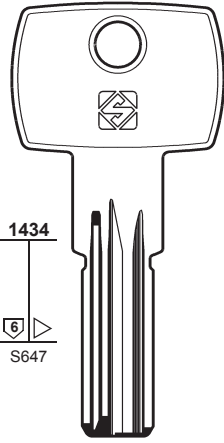

AGB7
SCUDO 5000

SCUDO

PER: **AGENT**
FOR:

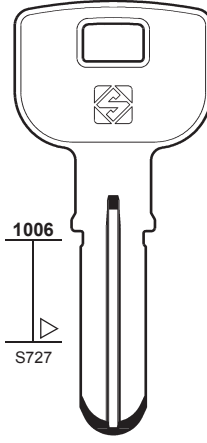

AGN1

PER: **AL AHRAM**
FOR:

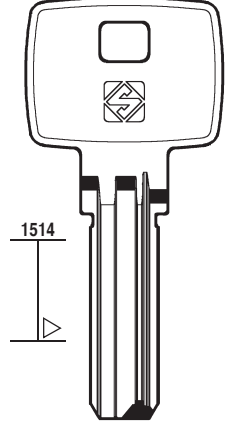

AHR2

PER: **ALPHA**
FOR:

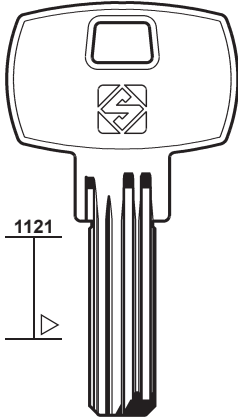

ALP16

PER: **AMIG**
FOR:

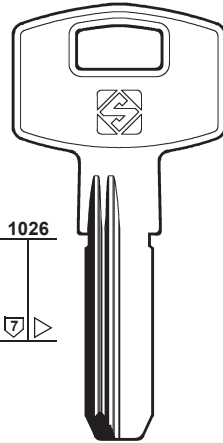

AMG1R

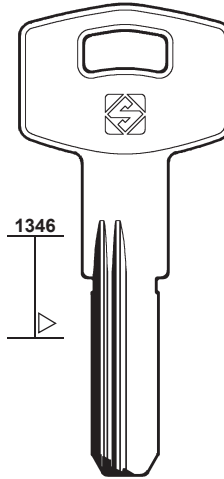

AMG2R

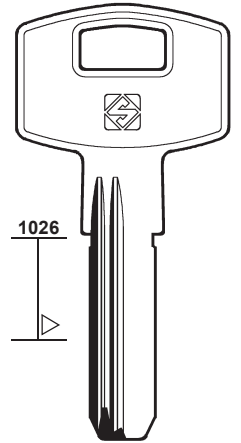

AMG3R

PER: **APEKS**
FOR:

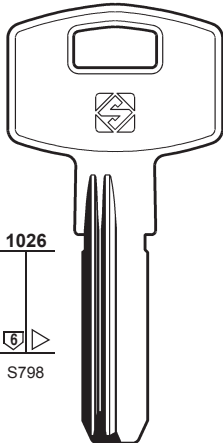

APK2R

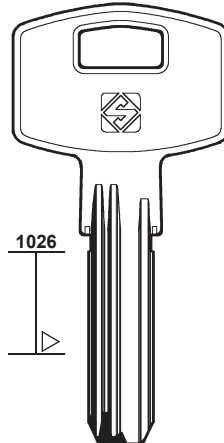

APK3R

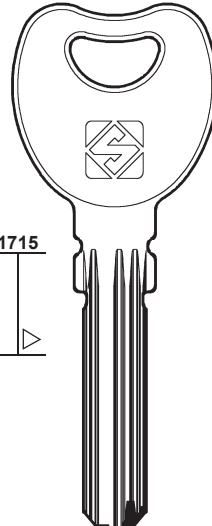

APK4

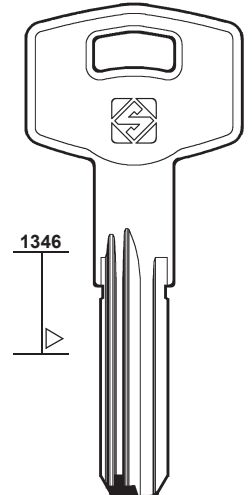

APK5R

PER:
FOR: **AXA**

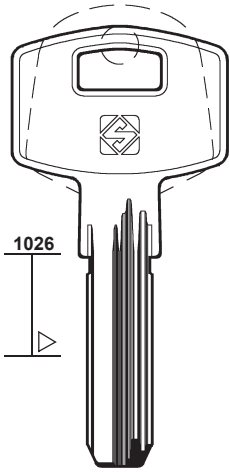

1026



AX12

AZBE

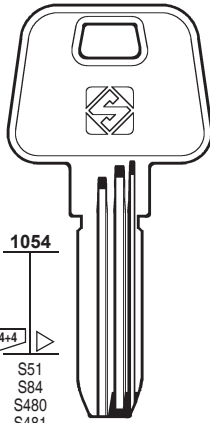

1054

5+4+4
S51
S84
S480
S481



AZ6
HS-4



AZ6R

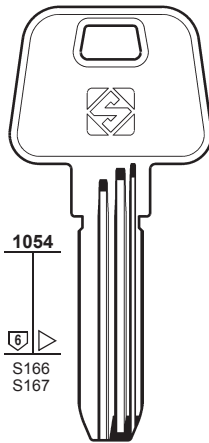

1054

6
S166
S167



AZ7
HS-6

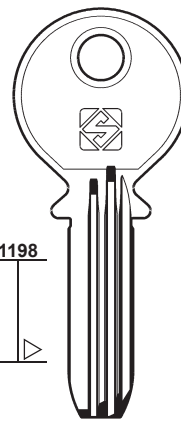

1198



AZ8

CAVERS



227

PER / FOR

AXA (NL)

AZBE (ES)
CAVERS

BAODEAN (CN)
+ CINA (229)

BASI (DE)
 SATURN (244)

BASSI (IT)
 GEVY (235)

BEY (TR)

BKS (DE)

BLINKY (CN)

BÖRKEY (DE)
 KABA (237)

PER:
FOR: **BAODEAN**

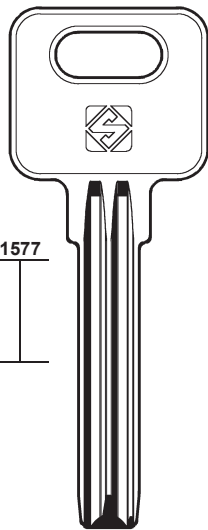

1577



BAE1

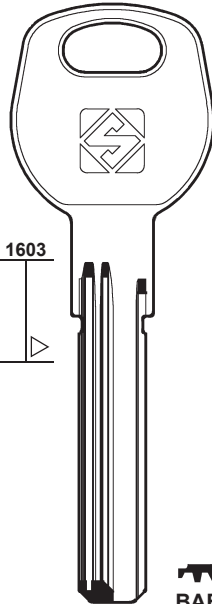

1603



BAE2R

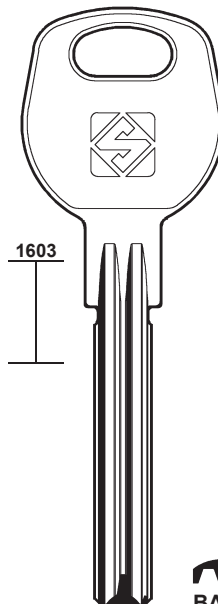

1603



BAE3

PER:
FOR: **BEY**

BEY

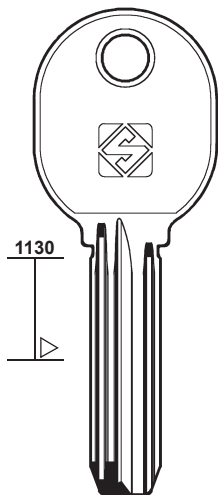

1130



BEY1R

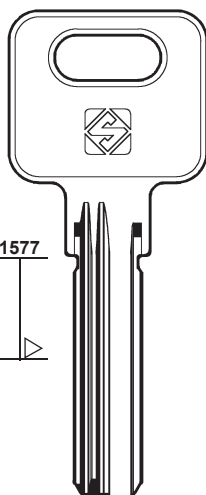

1577



BEY2R

BKS

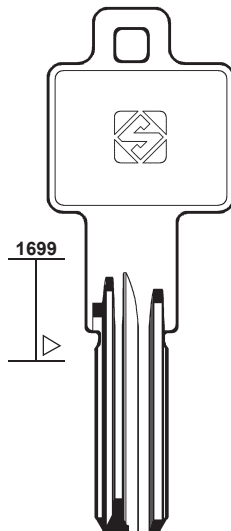

1699



BK61

BLINKY

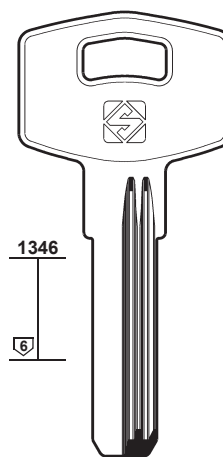

1346

6



BNK1



228

PER / FOR

BRICARD (FR)
 + ABUS (225)
 + CISA (229)

BRISANT (GB)
 HUGO

BSS (RS)
 URBIS (247)

BULAT (CN)

BULLOCK (IT)
 ZADI (249)

BURG (DE)

CASAS (ES)
 AGA (225)

CAS-CISMA (IT)
 MERONI
 SOBINCO

CAVERS (FR)
 AZBE (227)
 SPIDER (245)

CAYS (ES)

CES (DE)

CIERRA SOLA (AR)

BRICARD				BRISANT

BULAT	BURG		CAS-CISMA

CAS-CISMA	CAYS	CES	CIERRA SOLA

PER:
FOR:

CINA

1684
1684
1684
1624

RC10R
RC8R
RC9R
RC15R
RC16R

RC11R
RC11
RC9R

BAODEAN - HOOPLY
MASTER LOCK - MSM



229

PER / FOR

CINA (CN)
BAODEAN
HOOPLY
MASTER LOCK
MSM

CISA (IT)
ABUS
BRICARD
+ ABUS (225)

PER:
FOR:

CINA

CISA

1603
1603
999
A

RC17R
RC14R
CS48
CS70
(W60)

S87
S1043
S616

A/Z A/Z A/Z
000001-030198

ABUS - BRICARD
ASIX

PER:
FOR:

CISA

1456
1331
1219

CS146
CS144
CS139

CS62 (W08)
..... (XN008710) 1-11808
..... (XN005710) 1-38832
..... 900001-944826

CS115 (W05)
BRICARD

CS141 (W70)
..... (XN008710) 1-11808
..... (XN005710) 1-38832

CS140 (W72)
..... (XN008710) 1-11808
..... (XN005710) 1-38832

ASIX
NEW ASTRAL



230

PER / FOR

CISA (IT)
+ ABUS (225)

CITY (FR)
+ ISEO (236-237)

CODEM (FR)
+ FTH (234)

CODKEY (IL)
+ SPIDER (245)

COLOMENCA (ES)
+ AGA (225)

CORBIN (IT)
+ DOM (231-232)

CVL (ES)

DAF (TR)

DECAYEUX (FR)
+ PICARDIE (243)

DEFEND LOCK (CZ)

PER:
FOR:

CISA

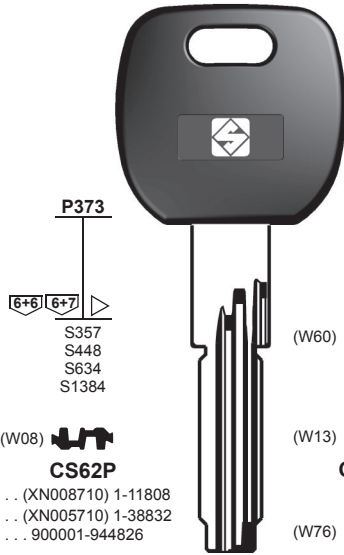

P373



S357
S448
S634
S1384

(W08) **CS62P**

..... (XN008710) 1-11808
..... (XN005710) 1-38832
..... 900001-944826

(W60) **CS70P ASIX**

(W13) **CS116P**

(W76) **CS139P**

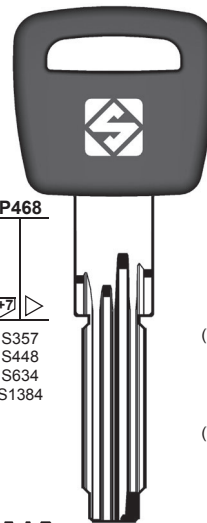

P468



S357
S448
S634
S1384

(W08) **CS62AP**

..... 900001-944826
..... (XN008710) 1-11808
..... (XN005710) 1-38832

CS155AP

CS154AP

(W76) **CS139AP**

(W13) **CS116AP**

(W60) **CS70AP**

CS159AP

CS158AP

CS157AP

CS156AP

PER:
FOR:

CORBIN

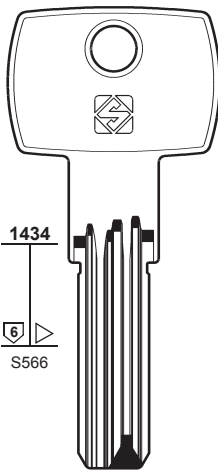

1434



S566

CB87

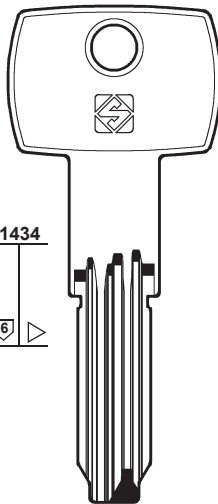

1434



CB97

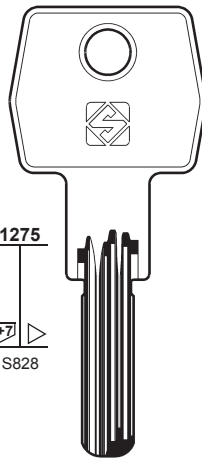

1275



S828

CB98

EURO STAR PLUS

CVL

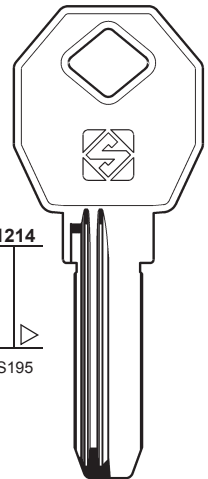

1214



S195

CVL5R
..... IC 8-7-6-5-4-3

PER:
FOR:

DAF

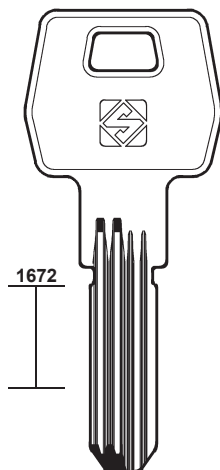

1672

DF4R

DEFEND LOCK

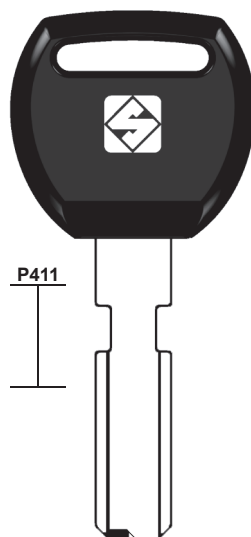

P411

DFE1RP

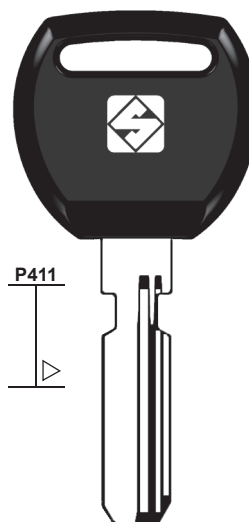

P411

DFE2P

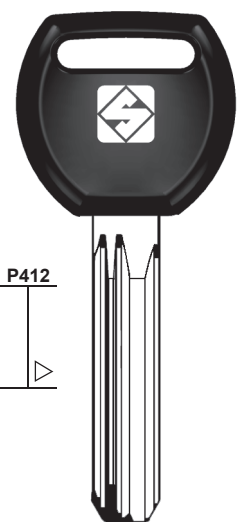

P412

DFE3RAP

PER:
FOR:

DEKABA

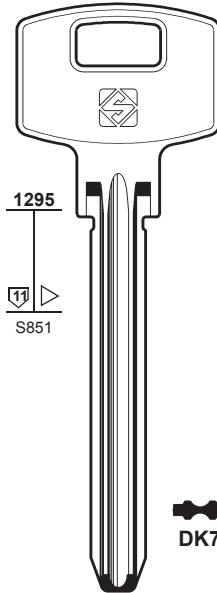
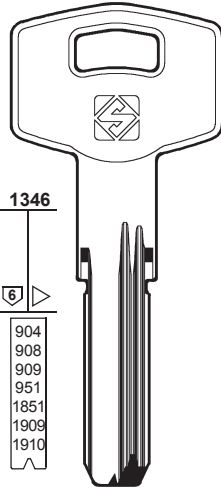
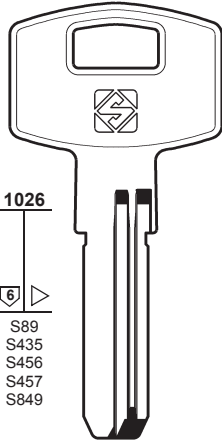
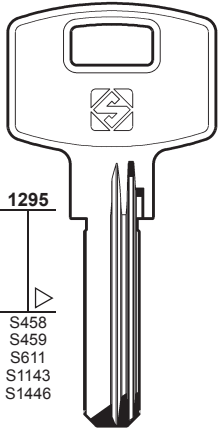

DK1

..... 00001-85798
..... 000001-028000



DK3

E2



DK6

E2



DK6X

..... 00016-280006



DK7

MAUER

MAUER



231

PER / FOR

DEKABA (BG)
MAUER

DELCA (GR)
GEVY

DIAM (FR)
LAPERCHÉ (239)

DIERRE (IT)

DOM (DE)
CORBIN
EMHART
IR
LAPERCHÉ

PER:
FOR:

DELCA

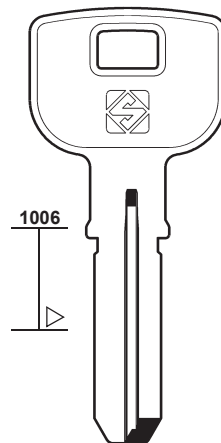
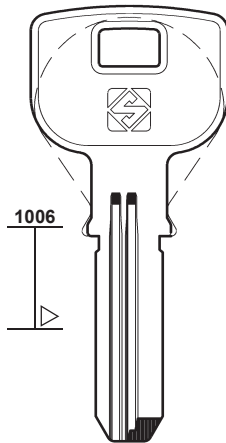
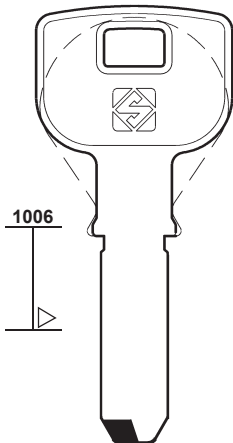
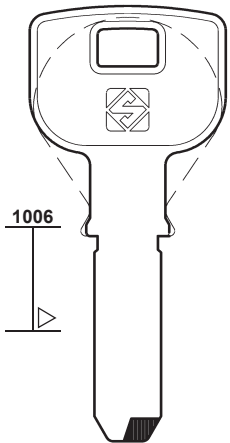

DLC1

DLC1R

DLC2R

DLC3

GEVY

GEVY

PER:
FOR:

DIERRE

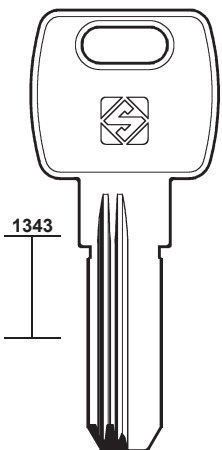

DIR1R

DOM

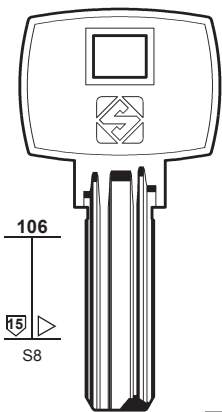

DM64

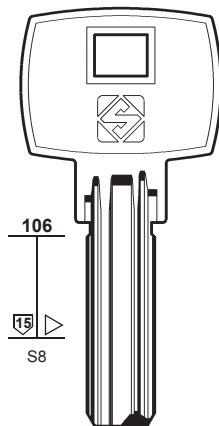

DM120

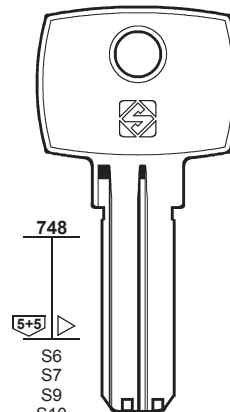

DM49

DM53

DM118

DM24
IX5

DM122

CORBIN - EMHART
IR - LAPERCHÉ

CORBIN



232

PER / FOR

DOM (DE)
CORBIN
EMHART
MOREAUX
STS

DOMUS (GR)

DORSET (IN)
KABA (237)

ELCA (DE)
STS
TESA
VIRO

ELZETT (HU)

PER:
FOR:

DOM

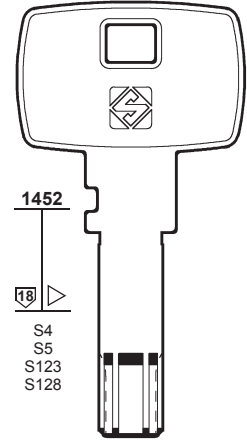
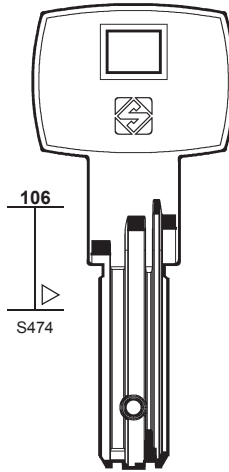
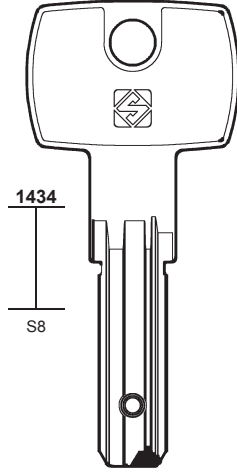

PER:
FOR:

DOM

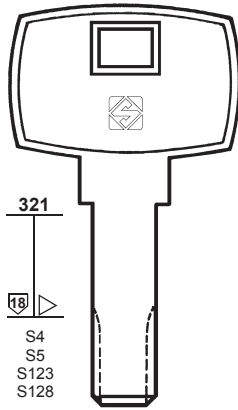

CORBIN - EMHART

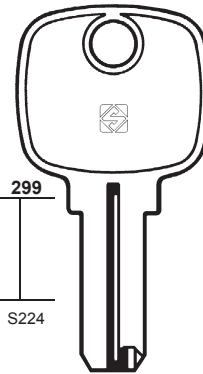

MOREAUX

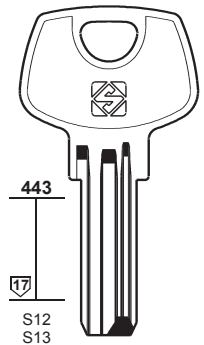

ALARM

PER:
FOR:

DOM

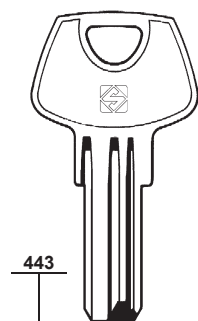

ALARM

DOMUS (GR)

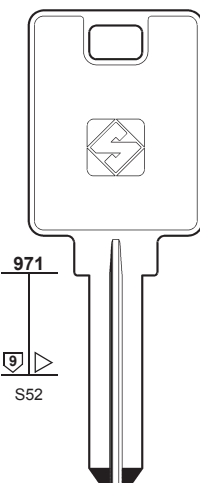

ELCA

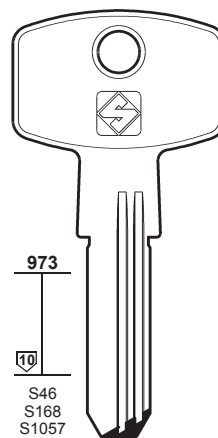

STS - TESA - VIRO

ELZETT

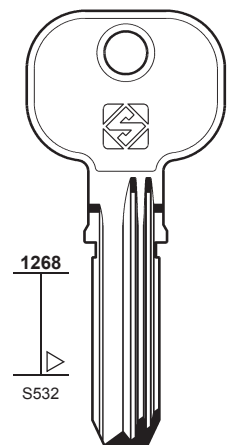

0-1-2-3-4



PER: **EURO LOCKS**
FOR:

EVVA

EZCURRA

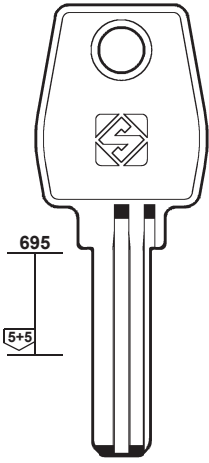

EU17

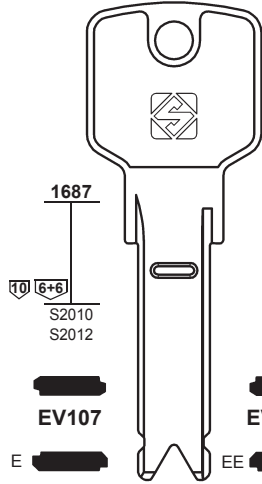

EV107
EV106
EV122

EV107R
EV106R
EV122R

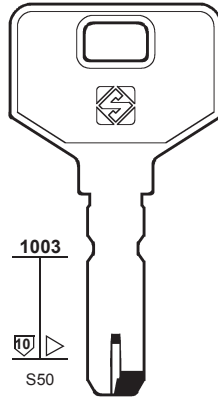

EZ3
DS10

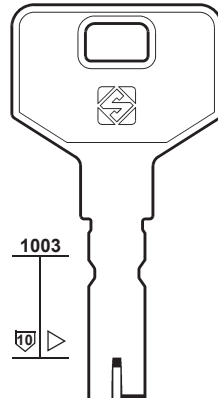

EZ3X
DS10



233

PER / FOR

EVVA (AT)

EMHART (US)
👁️ **DOM (231-232)**

ESAFE (ES)
👁️ **UCEM (247)**

EURO LOCKS (BE)

EZCURRA (ES)
+ 👁️ **SEA (244)**

FAC (ES)

PER:
FOR:

EZCURRA

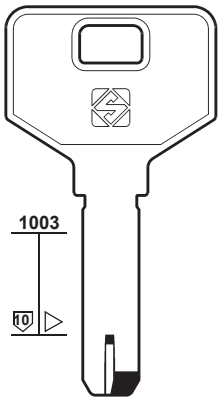

EZ6
DS15

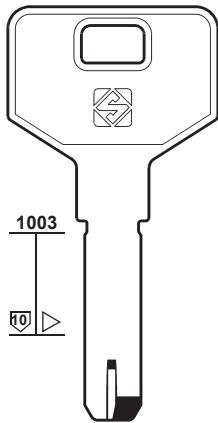

EZ6X
DS15

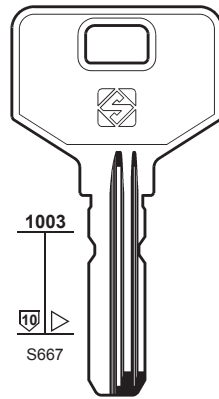

EZ4
DS10-E

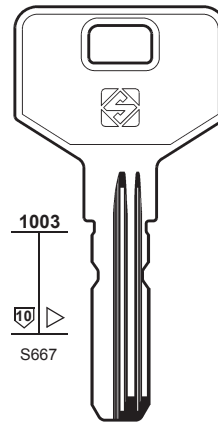

EZ4X
DS10

PER:
FOR:

EZCURRA

FAC

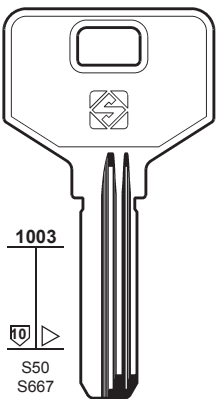

EZ5
DS15-E

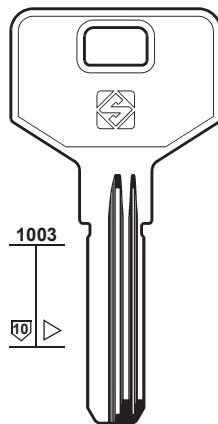

EZ5X
DS15

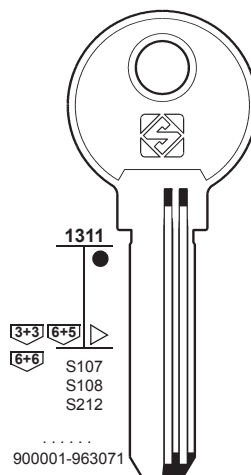

FAC15

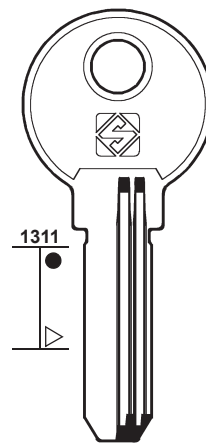

FAC31



234

PER / FOR

FAC (ES)

FAVOUR (DZ)

FAYN (TR)

FB (ES)
👁️ AGA (225)

FCV (DE)
KFV
VBH

FEB (IT)
👁️ VIRO (248)

F.F. (IT)

FIAM (IT)
+ 👁️ KESO (238)

FTH (FR)
CODEM
GOTTA
IFAM
ITO
KARO
SP
TOVER
YALTRES

PER: FAC

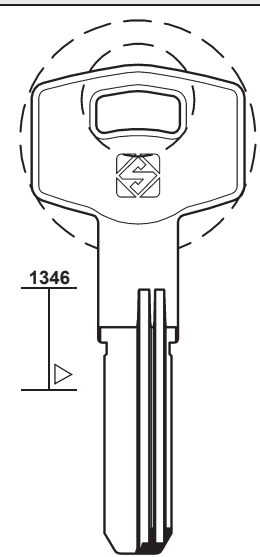

FAC32

PER: FAVOUR

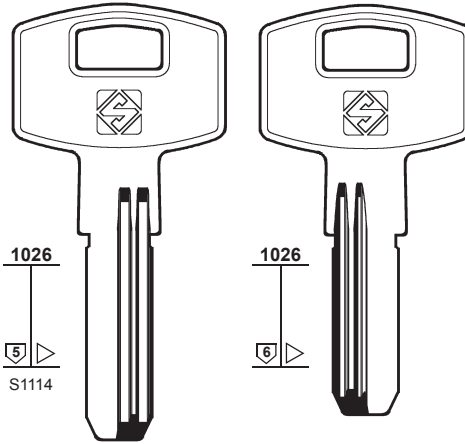

FVR1 FVR2R FVR4R FVR3

PER: FAYN

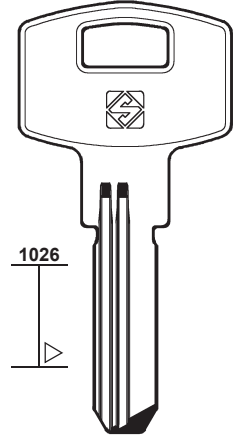

FY1R

PER: FCV

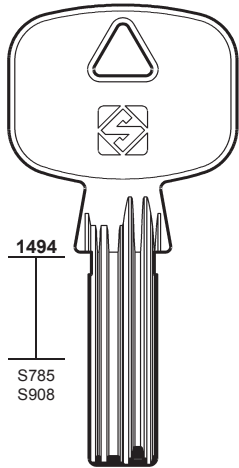

FV4

KFV - VBH

PER: F.F.

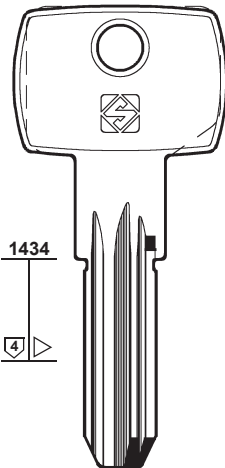

FF19

PER: FIAM

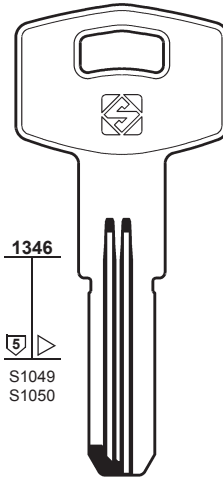

FI3R

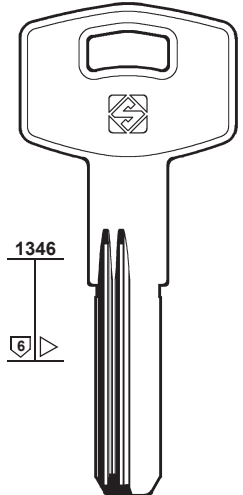

FI4R

PER: FTH

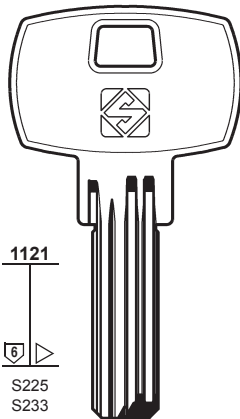

FH12

CODEM - GOTTA - ITO
TOVER - YALTRES

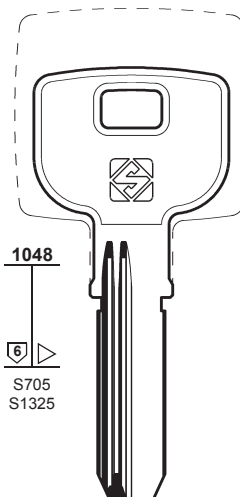

FH17R FH37R
..... 1-2-3-4-5

IFAM
KARO

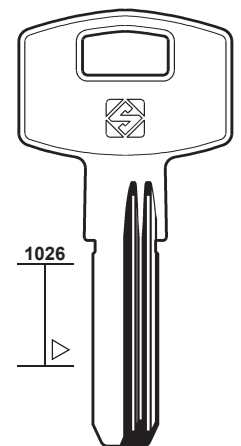

FH32

SP

PER:
FOR:

FTH

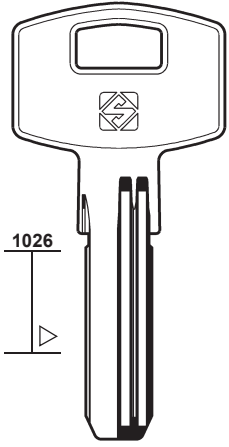

1026



FH33

SP

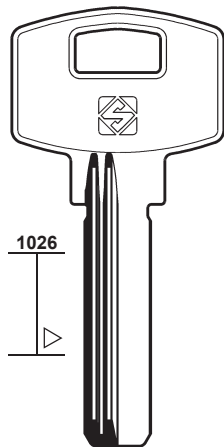

1026



FH34R

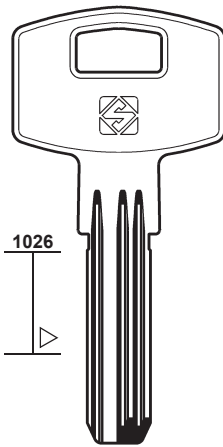

1026



FH35

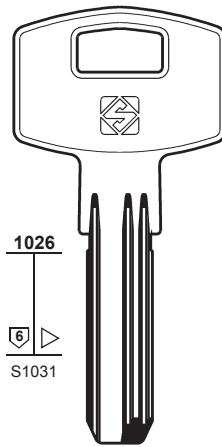

1026

6
S1031



FH36



235

PER / FOR

FTH (FR)

SP

GATEMATE (GB)

GARRISON (GB)

MUL.T.LOCK (242)

GEGE (AT)

GERDA (PL)

MCM (240)

GEVY (GR)

BASSI

MOTTURA

STUV

+ DELCA (231)

GIUSSANI (IT)

GOAL (JP)

GOTTA (DE)

FTH (234)

GP (IT)

PER:
FOR:

GATEMATE

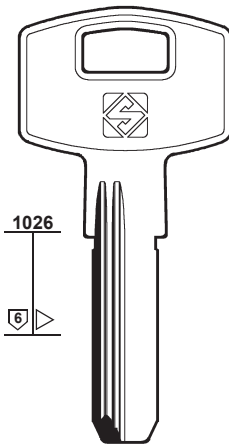

1026

6



GAT1R

GEGE

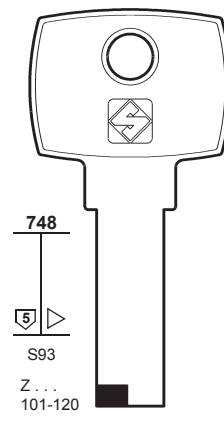

748

5

S93
Z...
101-120



GE57

GEVY

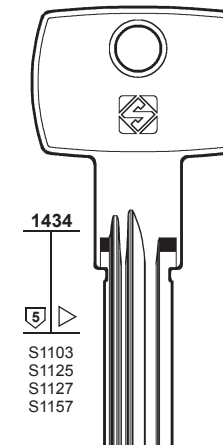

1434

5

S1103
S1125
S1127
S1157



GVY1R

..... 600001-613040
..... 900001-902780

BASSI - MOTTURA - STUV

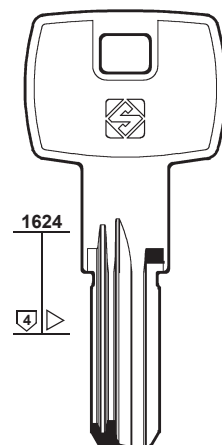

1624

4



GVY2R

BASSI

PER:
FOR:

GIUSSANI

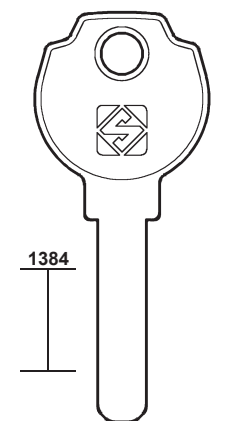

1384



GS17

GOAL

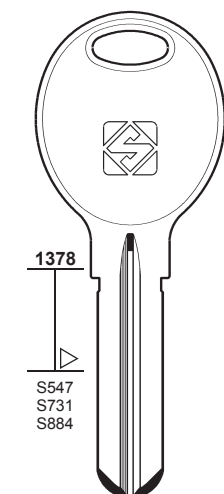

1378

S547
S731
S884



GO6

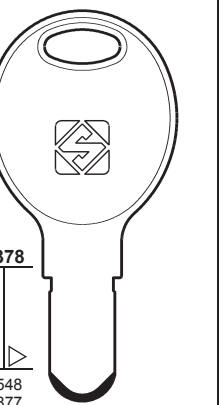

1378

3
S548
S877



GO7

GP

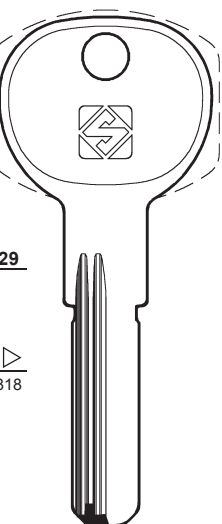

1129

7
S1818



GPI1



236

PER / FOR

GRIFO (TW)

HASLER (DE)

👁️ SEA (244)

HB (IT)

👁️ LEGALLAIS (239)

HOK (TR)

HOOPLY (TW)

👁️ CINA (229)

👁️ WANJIN (248)

HTEC (ES)

HUGO (DE)

+ 👁️ BRISANT (228)

IBFM (IT)

ICSA (IT)

👁️ LINCE (239)

IFAM (ES)

👁️ FTH (234)

I.R. (FR)

+ 👁️ DOM (231)

ISEO (IT)

CITY

VACHETTE

+ 👁️ UCEM (247)

PER: FOR:	GRIFO	HOK	HTEC	HUGO
	 1346 6 S906	 1434 6 S1850	 1049 11 S872	 1219 11 S872
	 GF1	 HOK1R HOK2R	 HTE1	 HGO1R

PER: FOR:	IBFM	IFAM	I.R.
	 1549 5 6 S1521 S1933 S1934	 1657 11 S872	 1434 11 S872
	 IBF2R	 IBF3R	 IF14

PER: FOR:	ISEO	
	 1129 5 S725 S726 S916 S965	 1130 5+6+6 S100 S723 S963 S964
	 IE30	 IE14 R11 IE15 R6

CITY - VACHETTE

PER:
FOR:

ISEO

Blue head
Testa blu

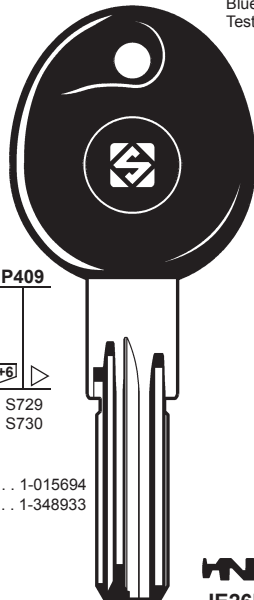
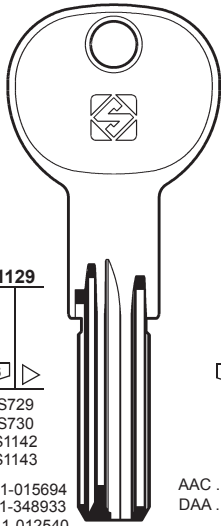

S729
S730
S1142
S1143

S729
S730

AAC 1-015694
DAA 1-348933
AMB 1-012540
AMB 100001-112540

AAC 1-015694
DAA 1-348933



IE26



IE26P

ATRA - CITY

ITO

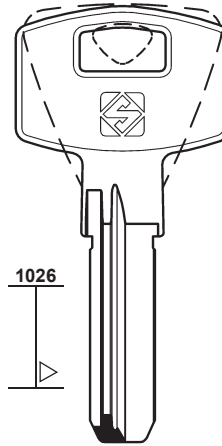
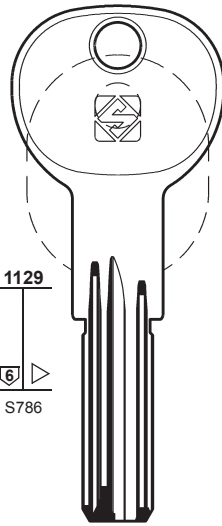

S786



IO1



IO2R



237

PER / FOR

ISEO (IT)
ATRA
CITY
+ UCEM (247)

ITO (TR)
+ FTH (234)

JPM (FR)
+ KESO (238)

KABA (CH)
BÖRKEY
DORSET
LÄSBOLAGET
PICARD

KAIXI (CN)

PER:
FOR:

KABA

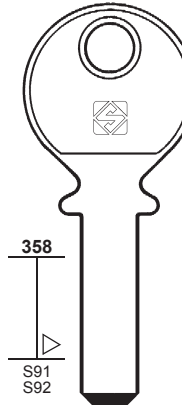
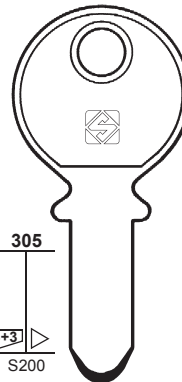
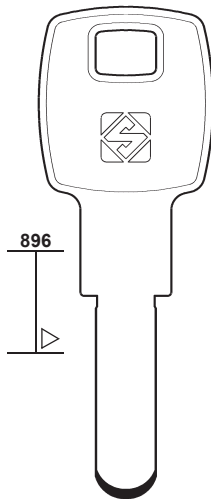
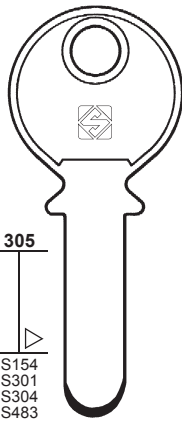
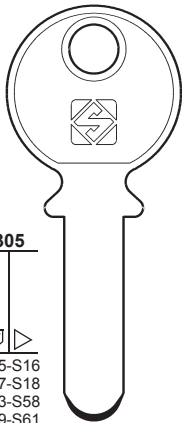

S15-S16
S17-S18
S53-S58
S59-S61
S114
PH
0001-9000
. . . 1-200

S154
S301
S304
S483

S200

S91
S92

mm 2
KA1
8

mm 2,5
KA2
20

mm 2,5
KA7

KA6

KA3
MINI KABA

LÄSBOLAGET

PICARD

BÖRKEY

PER:
FOR:

KABA

KAIXI

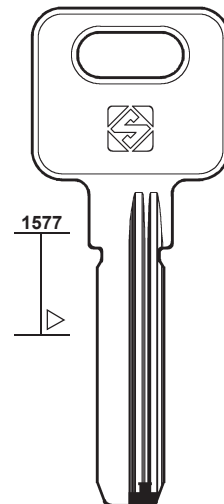
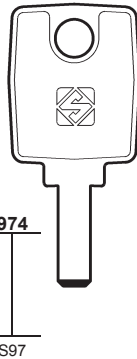
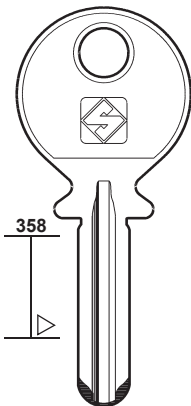
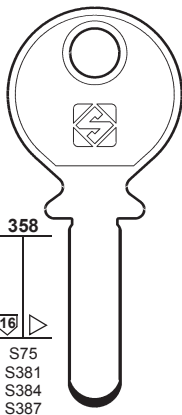
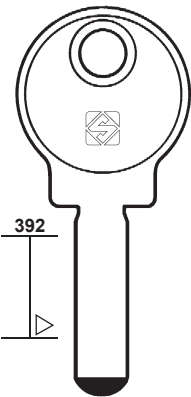

KA4

KA5

KA9

KA8
MICRO KABA



KAX1



KAX1R

GEMINI
DORSET





238

PER / FOR

KAKEN (KR)

KALE (TR)
+ TESA (246)

KARO (ES)
 FTH (234)

KESO (CH)
ALA
FIAM
JPM
LIPS
SARGENT

PER: **KAKEN**

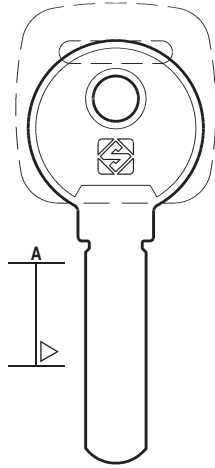

A

KAK1



FOR: **KALE**

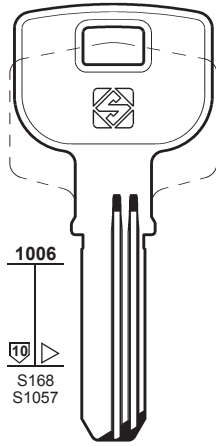

1006

S168
S1057

KLE1



KLE4

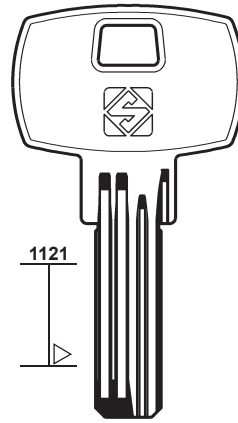

1121

KLE2R

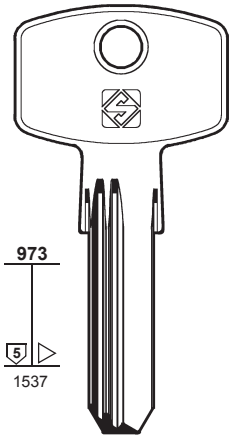

973

1537

KLE8R



PER: **KALE**

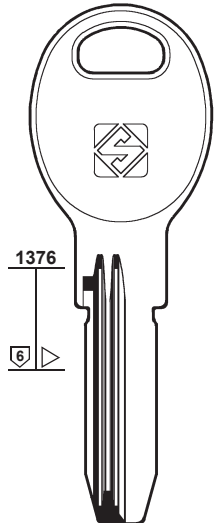

1376

S1643



KLE9R

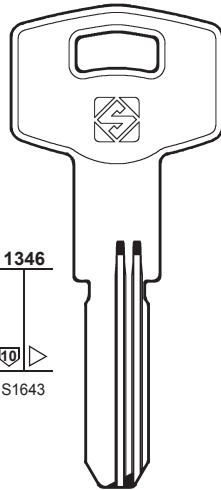

1346

S1643



KLE10R



KLE11

FOR: **KESO**

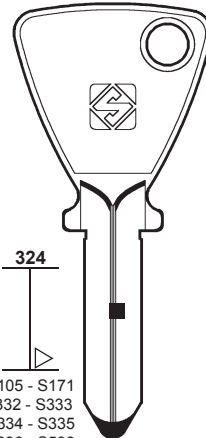

324

S105 - S171
S332 - S333
S334 - S335
S336 - S598
S599 - S600
S601 - S678
S807

KE1

JPM

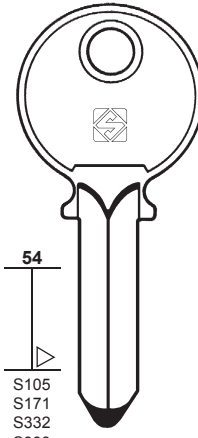

54

S105
S171
S332
S333
S334
S335
S336
S598
S599
S600
S601

KE2

JPM

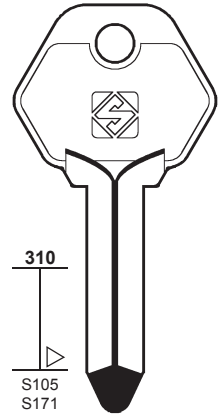

310

S105
S171
S332
S333
S334
S335
S336
S598
S599
S600
S601

KE4

SARGENT

PER: **KESO**

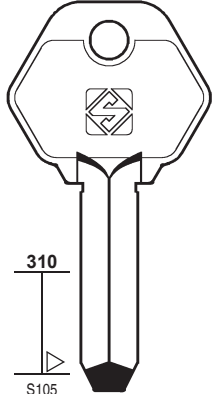

310

S105

LP11

LIPS

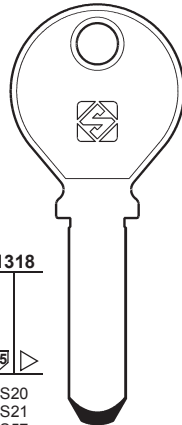

1318

S20
S21
S57
S267
S273
S277
S359
S1298

KE3

ALA

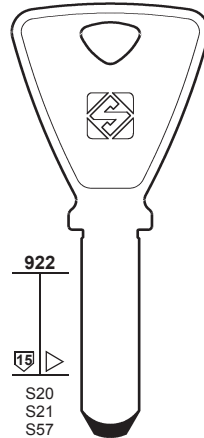

922

S20
S21
S57
S267
S273
S277
S359
S663
S1298

KE9

JPM

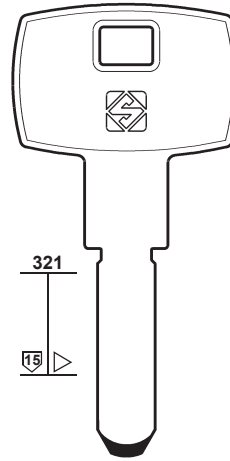

321

S2000

KE11

FIAM

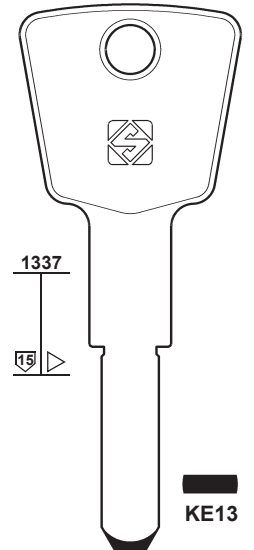

1337

KE13

FIAM

PER:
FOR: **KESO**

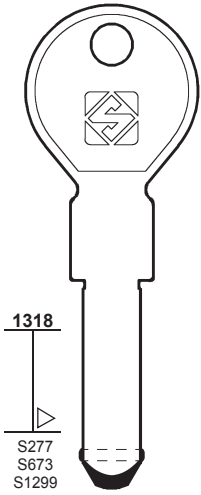

KE19

2000 S Omega
2000 S (STEP-DRILLING)

LAPERCHE

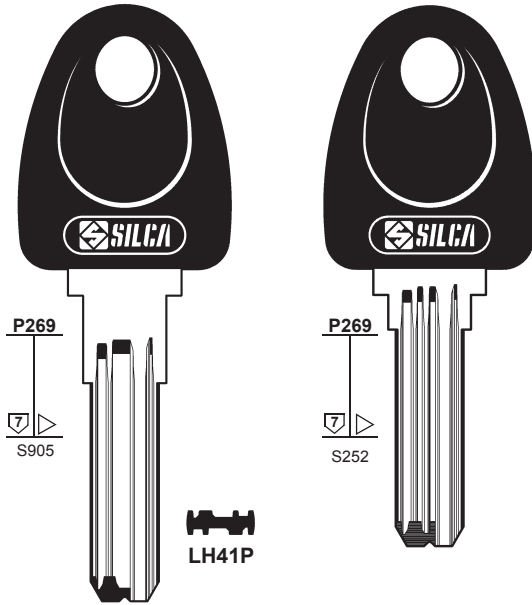

LH41P

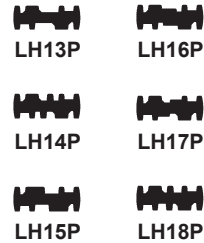

DIAM

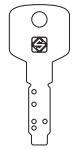

239

PER / FOR

KESO (CH)

KFV (DE)

👁️ **FCV** (234)

KYR (IT)

👁️ **SECURITAL** (244)

IMSI (IT)

👁️ **PERINO PG** (243)

JPM (FR)

👁️ **KESO** (238)

LAPERCHE (FR)

DIAM

+ 👁️ **DOM** (231)

LÅSBOLAGET (SE)

👁️ **KABA** (237)

LEGALLAIS (FR)

HB

LINCE (ES)

ICSA

LIPS (NL)

+ 👁️ **KESO** (238)

LOB (PL)

👁️ **MCM** (240)

LOCKSYS (BG)

PER:
FOR: **LEGALLAIS**

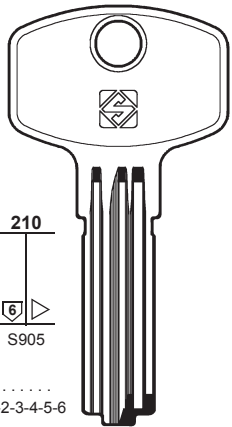

LEA1

HB

LEHMANN

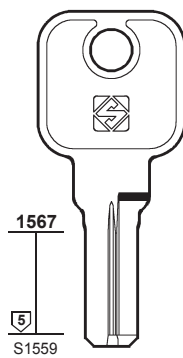

MLM9

MLM

LINCE

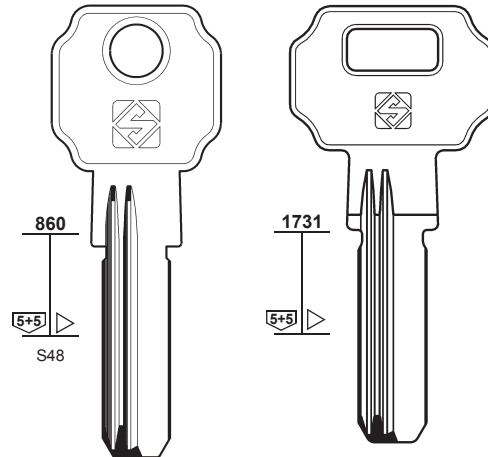

LC14R
X

ICSA

LC26R

PER:
FOR: **LIPS**

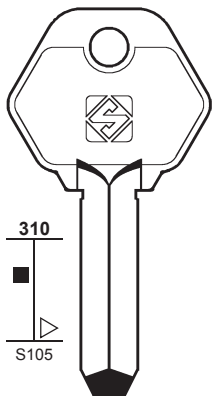

LP11

LOCKSYS

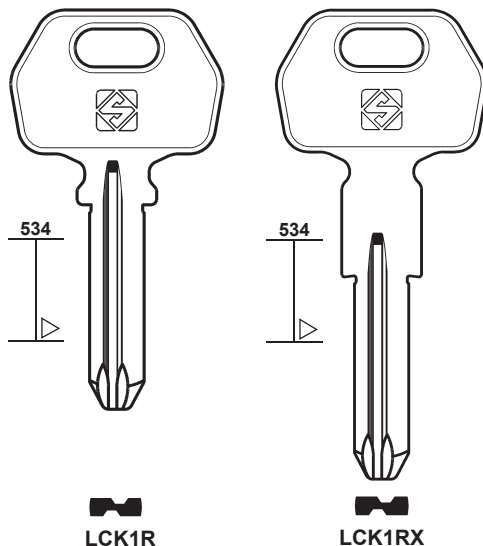

LCK1R

LCK1RX

LOK 2000

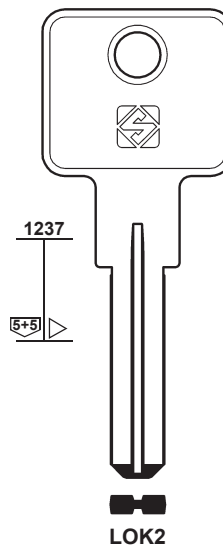

LOK2



mm 70



240

PER / FOR

MAGNUM (GB)

MASTER (US)

+ TOVER (246)

MASTER LOCK (CN)

+ CINA (229)

MAUER LOCKS (BG)

DEKABA (231)

MCM (ES)

GERDA
LOB
TROMER
YETI

PER: MAGNUM

FOR:

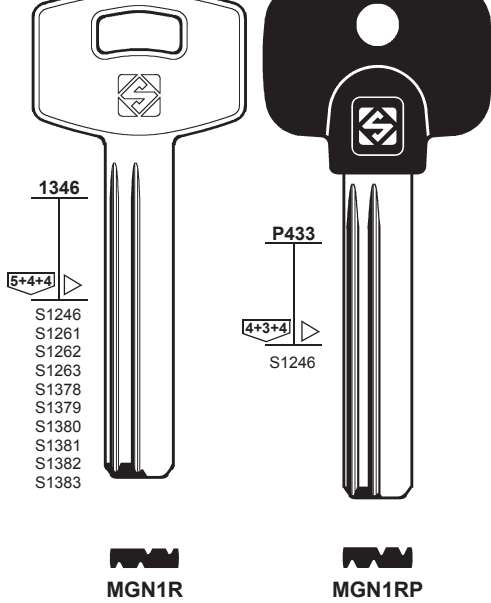

PER: MASTER

FOR:

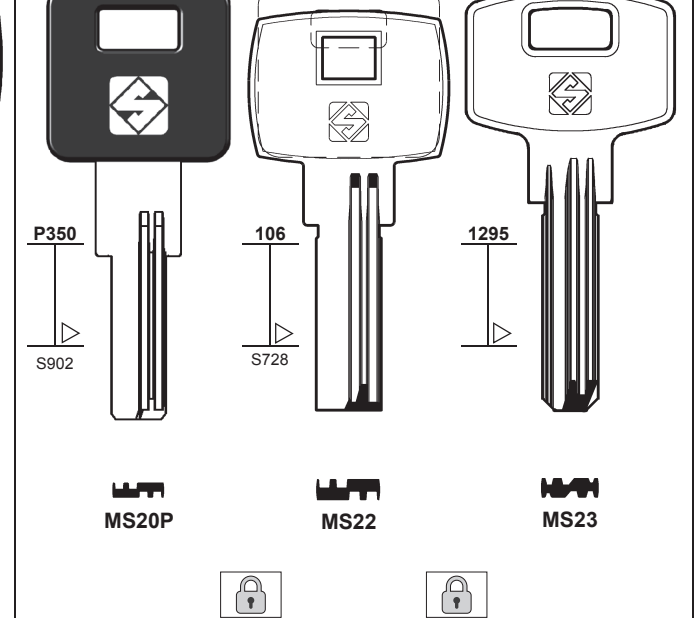

PER: MASTER LOCK

FOR:

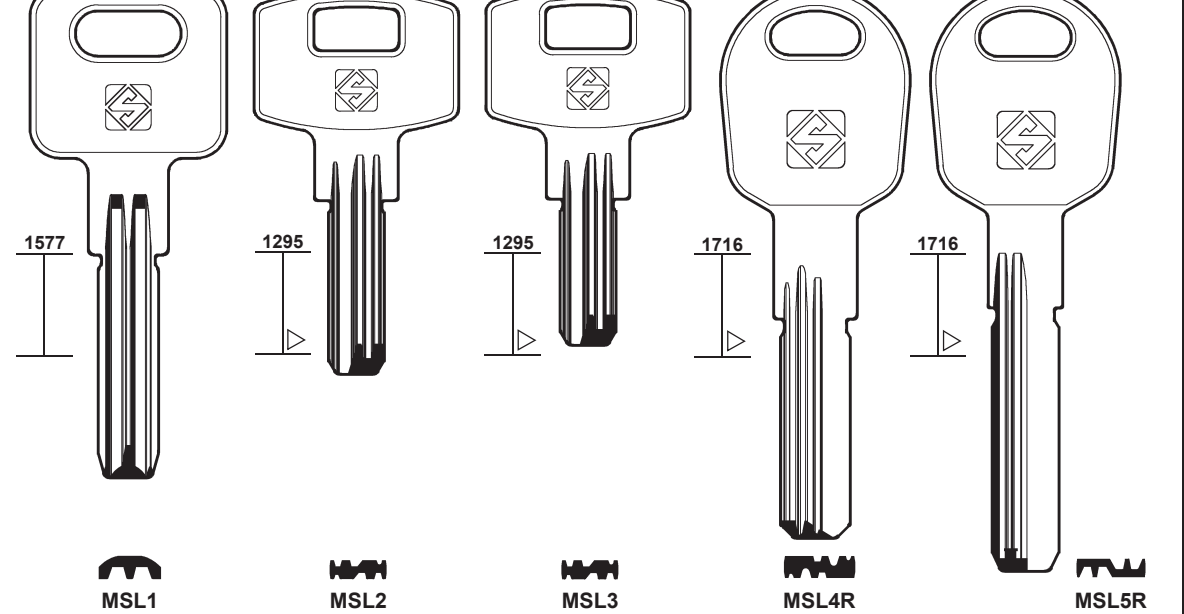

PER: MCM

FOR:

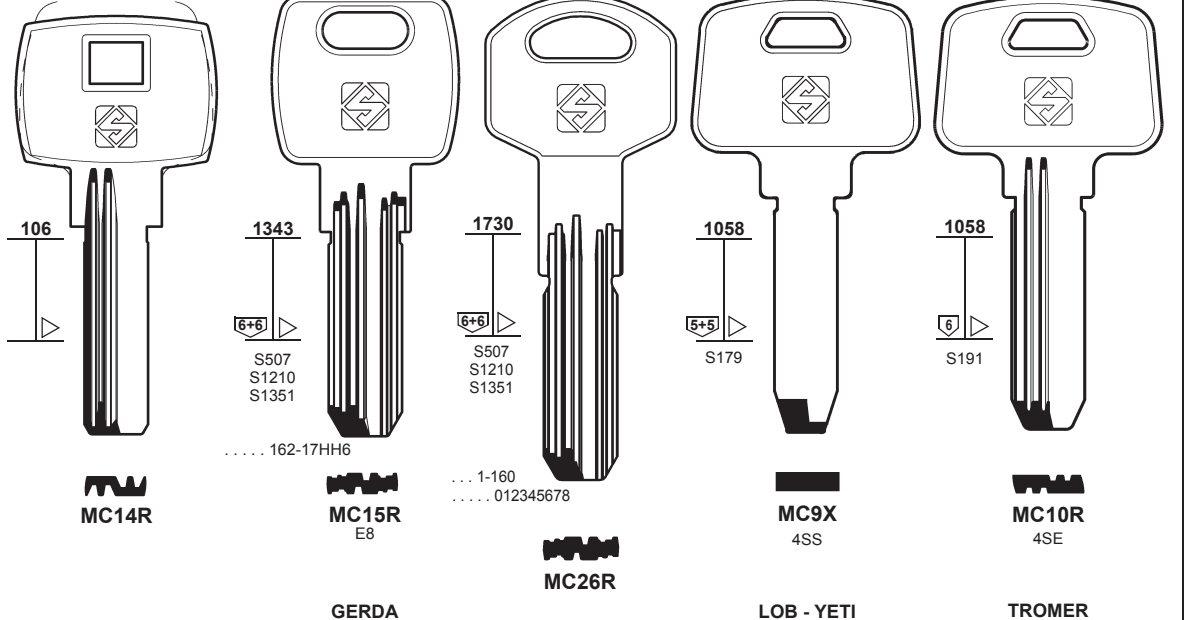

PER:
FOR: **MEGA**

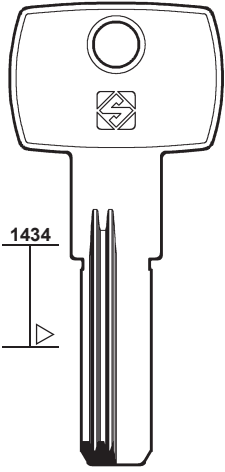

1434



MEG1R

MERONI

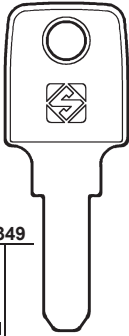

1349
S1139



MER39
WA.....

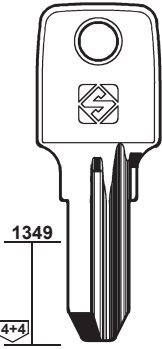

1349



MER38

METAL

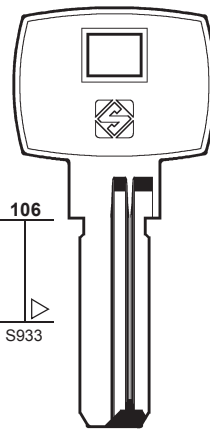

106
S933



MTA2

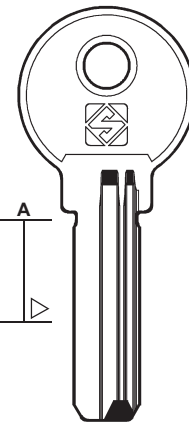

A



MTA4



241

PER / FOR

MEGA (RO)

MERONI (IT)

+ CAS-CISMA (228)

METAL (BG)

MG (MONTI) (IT)

MLM (FR)

MODA (FR)

+ PICARDIE (243)

MOREAUX (FR)

+ DOM (232)

MOTTURA (IT)

+ GEVY (235)

+ CAS-CISMA (228)

MSM (CN)

+ CINA (229)

MULT-LEI (GR)

MUL.T.LOCK (IL)

PER:
FOR: **MG (MONTI)**

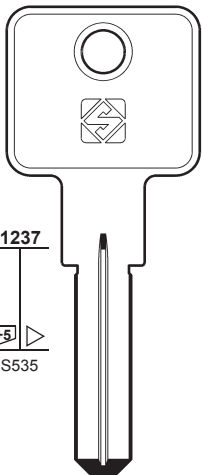

1237
S535

5+5+5



MG8
PBA

.....
001001-163000

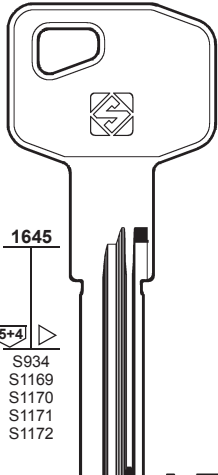

1645
S934
S1169
S1170
S1171
S1172

5+4



MG9
X8

A5 00010-28000
A6 00010-28000
A7 00010-28000
A8 00010-28000

MLM

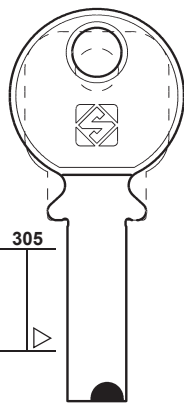

305



MLM5

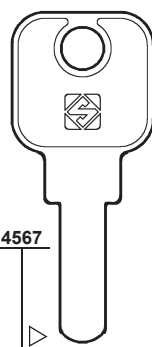

4567



MLM15

MOIA

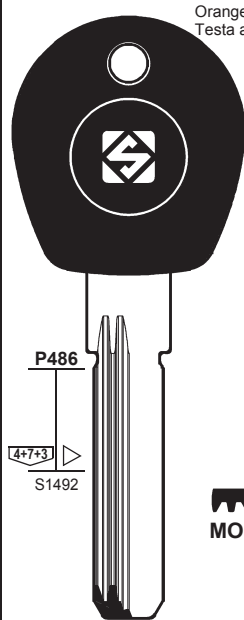

Orange head
Testa arancione

P486
S1492



MO1RP

PER:
FOR: **MULT-LEI**

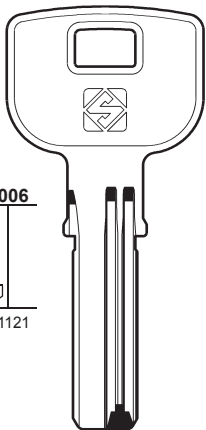

1006
S1121



MTL1

MUL.T.LOCK

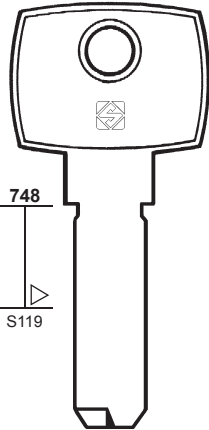

748
S119



MTK1

J.....
9001-9766

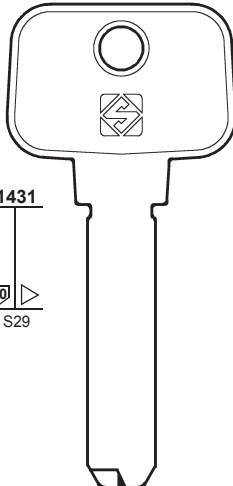

1431
S29

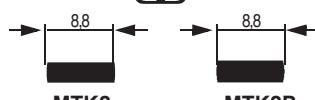

MTK2

(006)
ABCD-12345

MTK2P

(006)
ABCD-12345

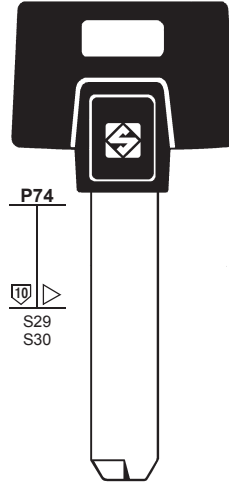

P74
S29
S30



MTK3P

(006)
ABCD-12345-01



242

PER / FOR

MUL.T.LOCK (IL)
GARRISON
SP

OJMAR (ES)

OMEC (IT)
SANTOS

PER:
FOR:

MUL.T.LOCK

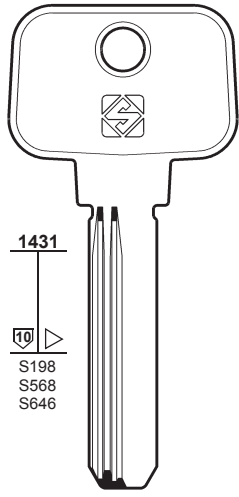

1431



S198
S568
S646

06 MTK11R

05 MTK11
(005)
ABCD-12345

MTK10R
(006)
ABCD-12345-01

64 MTK8R
(006)
ABCD-12345-01

50 MTK7R
(006)
ABCD-12345-01

GARRISON

11 MTK16

66 MTK15R

77 MTK13R

08 MTK12R
(008)
ABCD-12345

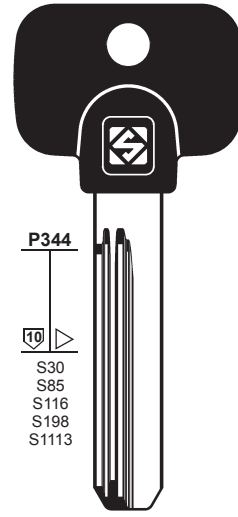

P344



S30
S85
S116
S198
S1113

MTK10RP
(006)
ABCD-12345-01

MTK9RP

64 MTK8RP
(006)
ABCD-12345-01

50 MTK7RP
(006)
ABCD-12345-01

05 MTK4P
(005)
ABCD-12345

06 MTK4RP
(006)
ABCD-12345-01

SP

PER:
FOR:

MUL.T.LOCK

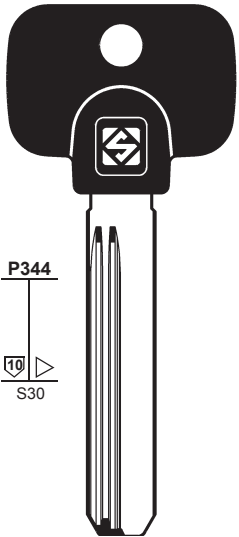

P344



S30

06 MTK4RPX

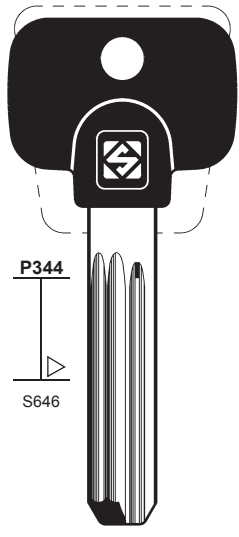

P344



S646

08 MTK12RP
(008)
ABCD-12345

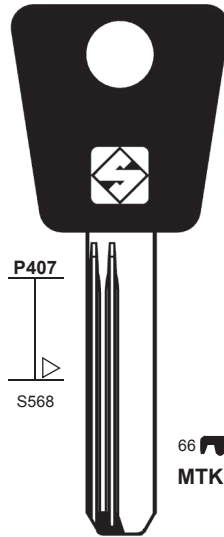

P407



S568

66 MTK15RAP

77 MTK13RAP

GARRISON

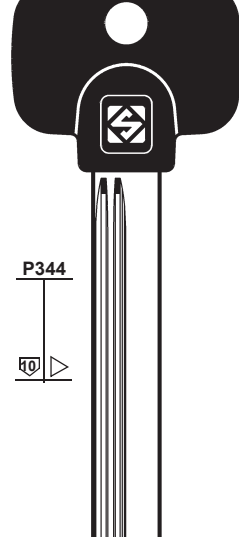

P344



MTK14RP

PER:
FOR:

OJMAR

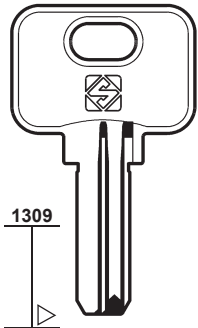

1309



OJ14

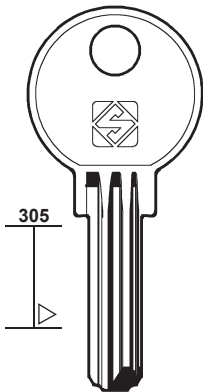

305



OJ18
5-Q4

PER:
FOR:

OMEC

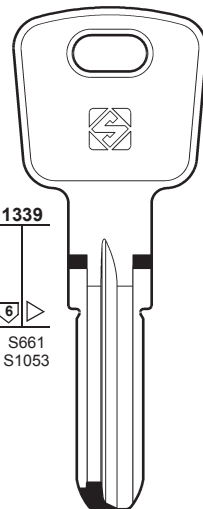

1339



S661
S1053

OC3

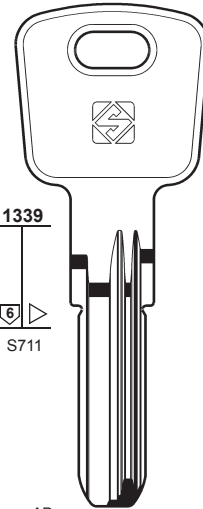

1339



S711

AB
0000001-0046656

OC4

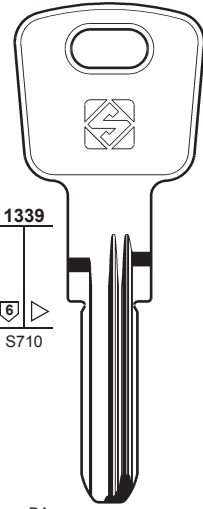

1339



S710

BA
0000001-0046656

OC6

SANTOS

PER: **PENZA** PERINO PG PICARDIE

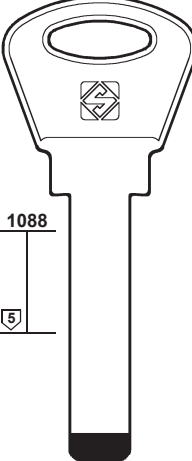
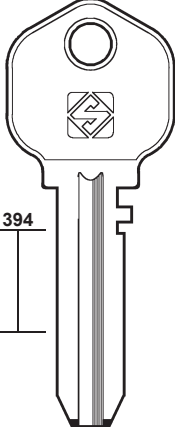
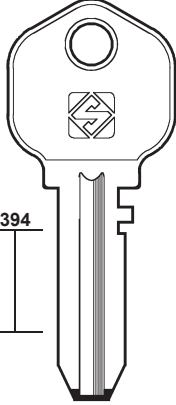
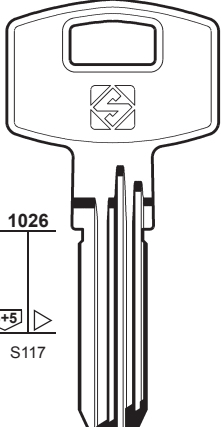
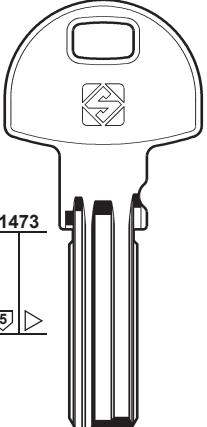
 <p>1088</p> <p>5</p> <p>BZ3</p>	 <p>394</p> <p>PN1</p>	 <p>394</p> <p>PN2</p>	 <p>1026</p> <p>6+5</p> <p>S117</p> <p>PIC1</p>	 <p>1473</p> <p>5</p> <p>PIC2</p>
	IMSI		DECAYEUX - MODA S & E - STS	



243

PER / FOR

PENZA (RU)

PERINO PG (IT)
IMSI

PICARDIE (FR)
DECAYEUX
MODA
S & E
STS

PICARD (FR)
KABA (237)



POTENT (IT)

PREFER (IT)

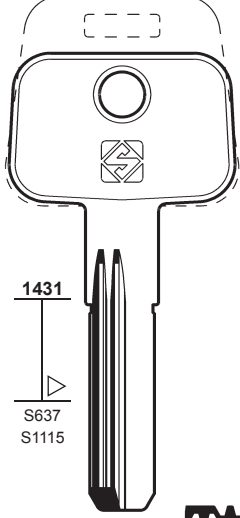
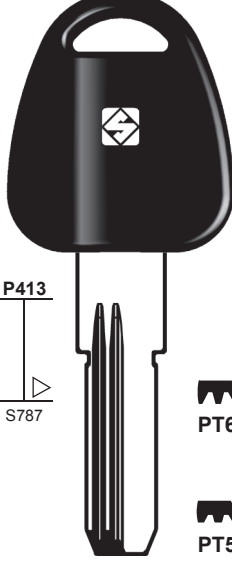
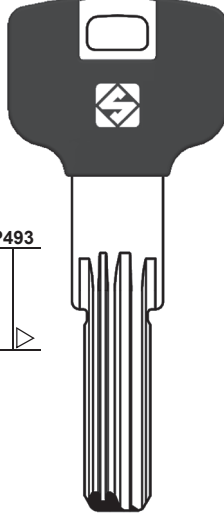
PER: **POTENT**

 <p>1431</p> <p>S637 S1115</p> <p>PT4R 1-2-3-4-5</p>	 <p>P413</p> <p>S787</p> <p>PT6RP</p>	 <p>P493</p> <p>PT7RAP</p>
	<p>PT5RP P04 1-2-3-4-5-6</p>	

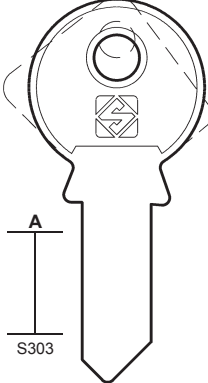
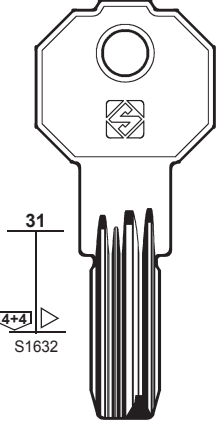
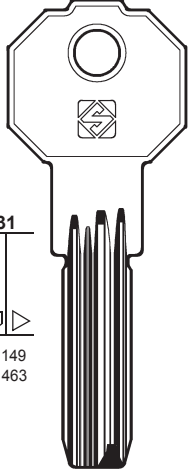
PER: **PREFER**

 <p>A</p> <p>S303</p> <p>PF18</p>	 <p>31</p> <p>4+4</p> <p>S1632</p> <p>PF22</p>	 <p>31</p> <p>5</p> <p>S1149 S1463</p> <p>PF20</p>	 <p>PF21</p>
---	--	---	--



244

PER / FOR

ROSSETTI (RO)

S-TECH (GB)

S & E (FR)
PICARDIE (243)

SANTOS (PT)
OMEC (242)

SARGENT (US)
KESO (238)

SATURN (SI)
BASI

SEA (CH)
EZCURRA
HASLER
VIDMAR

SECUREMME (IT)

SECURIT (IT)

SECURITAL (IT)
KYR

SERRALLER (ES)
AGA (225)

SOBINCO (BE)
CAS-CISMA (228)

SP (FR)
FTH (234-235)
MUL.T.LOCK (242)

PER: **ROSSETTI**

FOR:

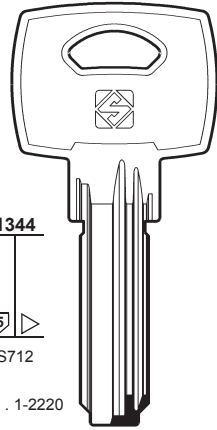

RSS3

PER: **S-TECH**

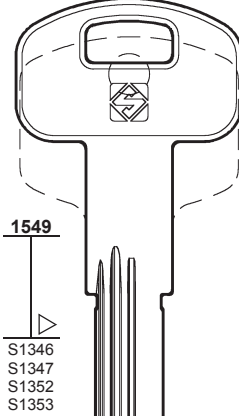

SCH1R

PER: **SARGENT**

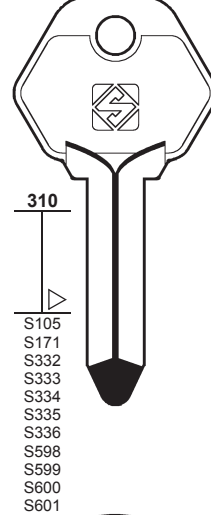

KE4

KESO

PER: **SATURN**

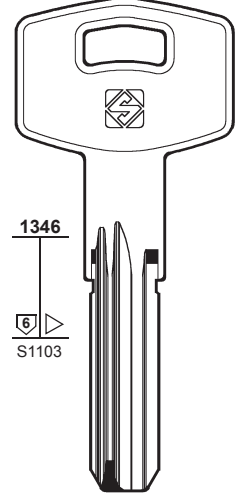

STU6R

BASI

PER: **SEA**

FOR:

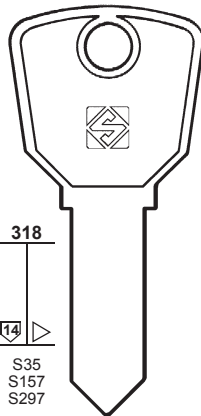

SEB1
20-23

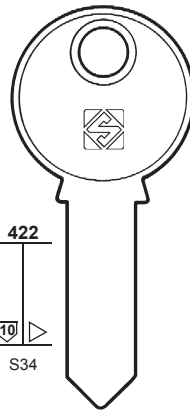

SEB2

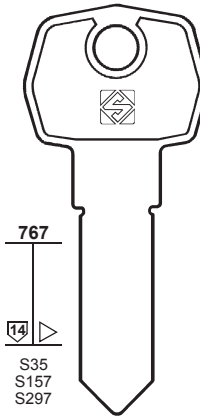

SEB3
20-23

EZCURRA - HASLER

EZCURRA - HASLER - VIDMAR

PER: **SECUREMME**

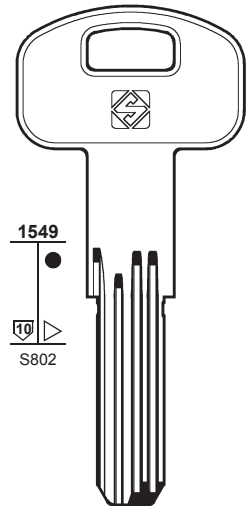

SCM1R
K2

PER: **SECUREMME**

FOR:

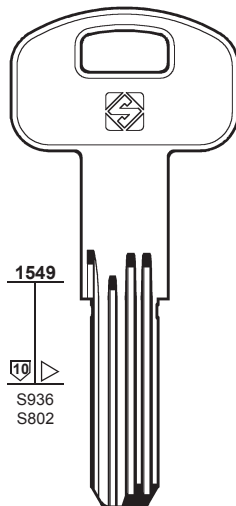

SCM2
K1

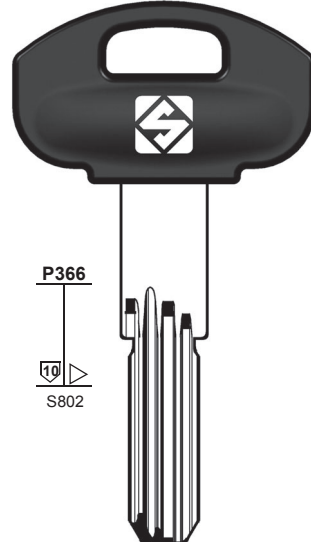

SCM3RP

PER: **SECURIT**

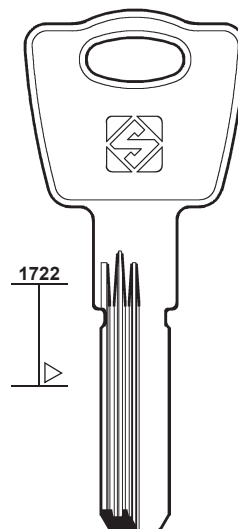

SCT1R

PER: **SECURITAL**

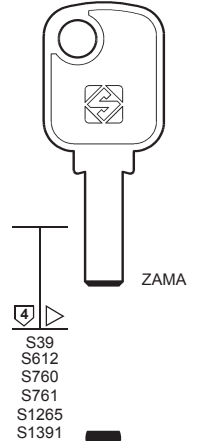

SCU1

KYR

PER:
FOR:

SPIDER

STS



245

PER / FOR

SPIDER (IL)
CAVERS
CODKEY

STS (ES)
TESA
+ DOM (232)
+ ELCA (232)
+ PICARDIE (243)
+ TESA (246)

STUV (DE)
 GEVY (235)

SÜDMETALL (DE)

TARONI (IT)

TECON (ES)

TECSESA (ES)

TEGASI (GR)

TERCA (ES)
 AGA (225)

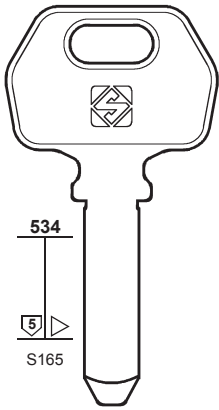

534

5

S165

SPR1

CODKEY

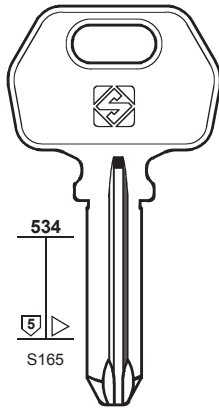

534

5

S165

SPR2

CAVERS

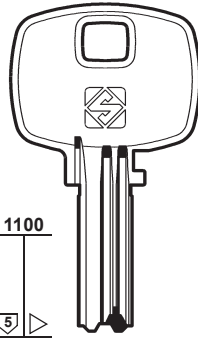

1100

5

S199

S1104

STS5

K 5001-8030

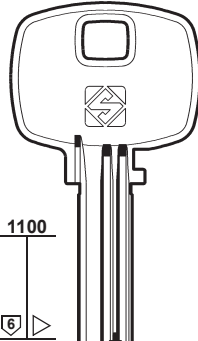

1100

6

S38

S62

S199

S436

S1104

STS6

J
K
P 5001-8030
K 5001-8030

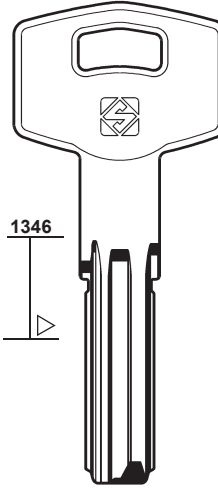

1346

STS9

PER:
FOR:

STS

SÜDMETALL

TARONI

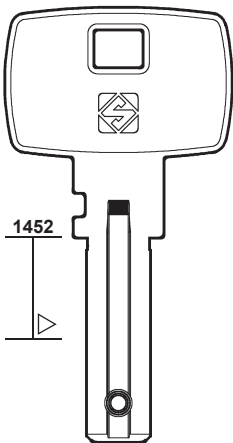

1452

STS12

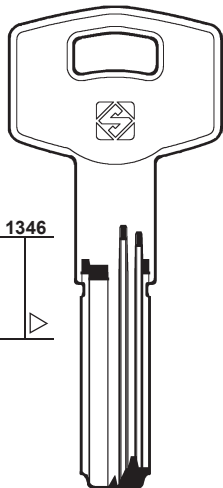

1346

STS13

TESA

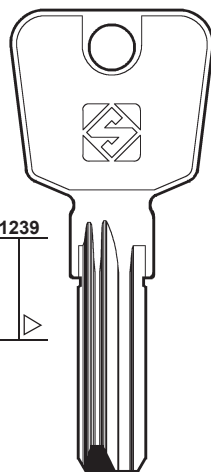

1239

SDT1R

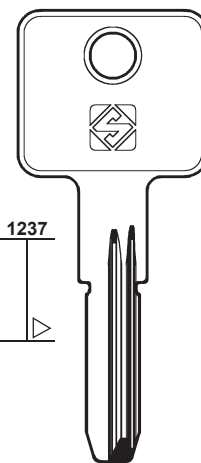

1237

TAR21

PER:
FOR:

TARONI

TECON

TECSESA

TEGASI

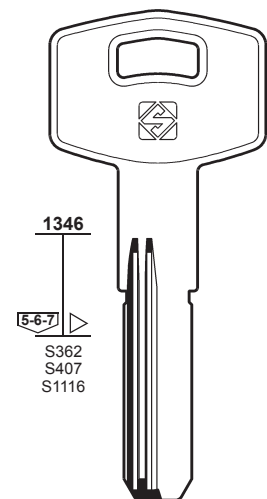

1346

5-6-7

S362

S407

S1116

TAR16

TAR16R

TARONI

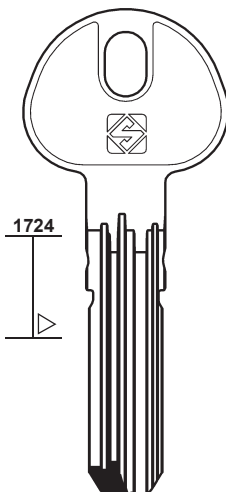

1724

TEN1

TECON

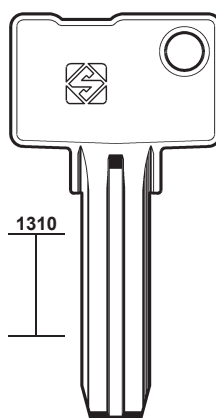

1310

TEC1

TECSESA

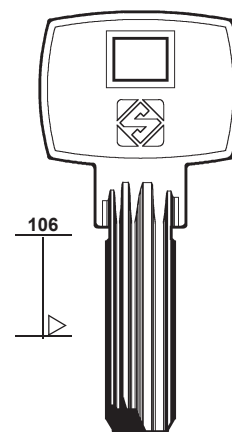

106

TGS1R

TEGASI



246

PER / FOR

TESA (ES)
KALE
STS
VIRO
+ ELCA (232)
+ STS (245)

THIRARD (FR)

TILANCO (FR)

TITAN (SI)

TOVER (ES)
MASTER
TROMER
+ FTH (234)

PER: FOR: TESA

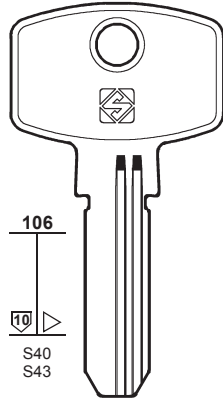

106



S40
S43



TE4

T-10



TE4R

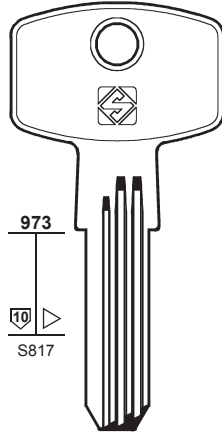

973



S817



TE16

T-10P

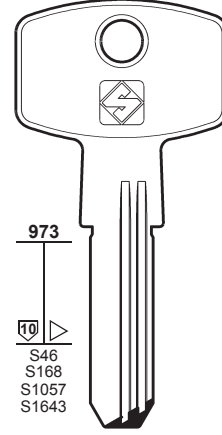

973



S46
S168
S1057
S1643



EC5

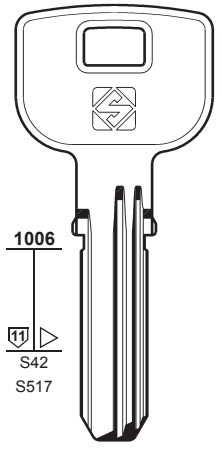

1006



S42
S517



TE5

T-80



TE9

T80/SC

STS

KALE - STS - VIRO

STS

PER: FOR: TESA

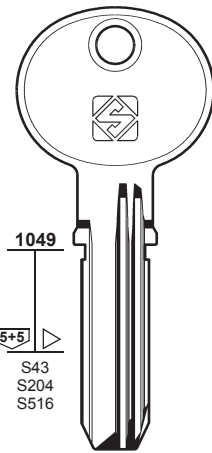

1049



S43
S204
S516



TE7

T-60

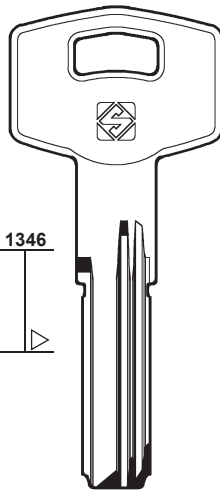

1346



TE19

STS

THIRARD

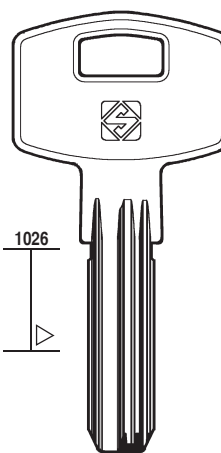

1026



THR1

TILANCO

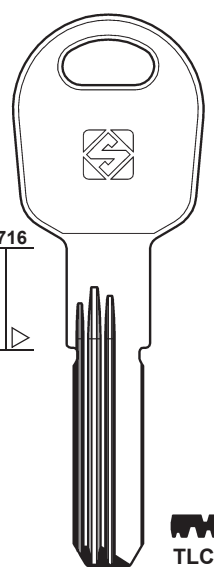

1716



TLC1R

PER: FOR: TITAN

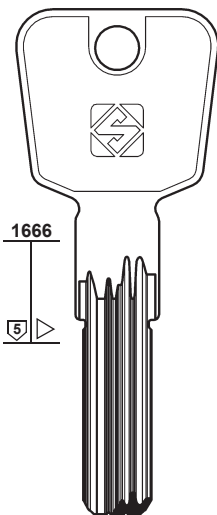

1666



TN51



TN32

TOVER

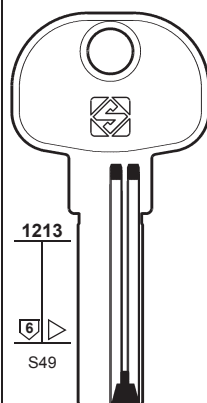

1213



S49



TV1

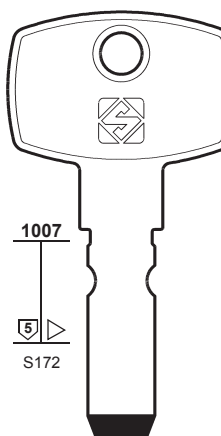

1007



S172



TV2

2F-35

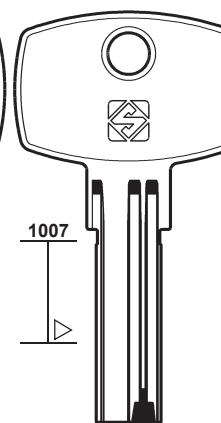

1007



TV3

2F-25

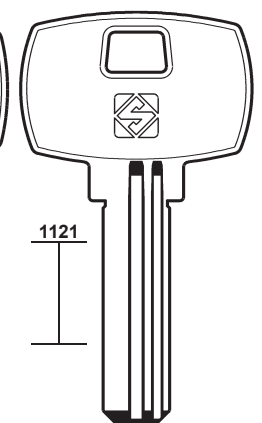

1121



TV4

MASTER

TROMER

PER:
FOR: **TRIMARK**

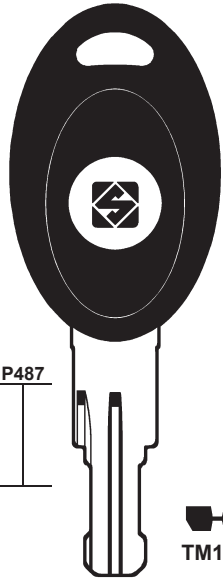

TM1RP

UCEM

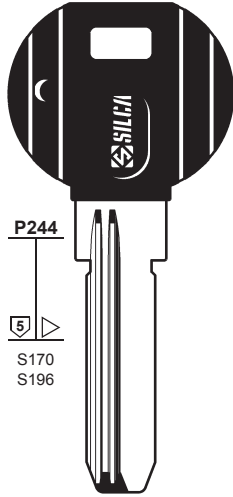

UC3RP
2000S

ESAFE - ISEO
YEMAR

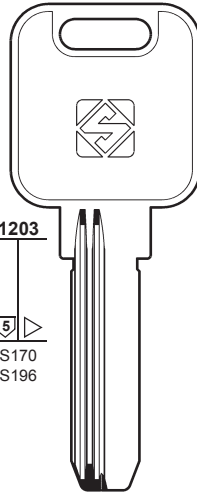

UC5R

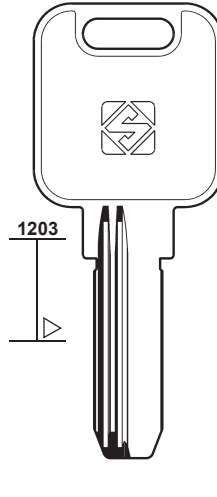

UC4R



247

PER / FOR

TRIMARK (US)

TROMER (ES)
MCM (240)
TOVER (246)

UCEM (ES)
ESAFE
ISEO
YEMAR

URBIS (RO)
BSS
YALE

VACHETTE (FR)
+ ISEO (236)

VANGUARD (AR)

PER:
FOR: **UCEM**

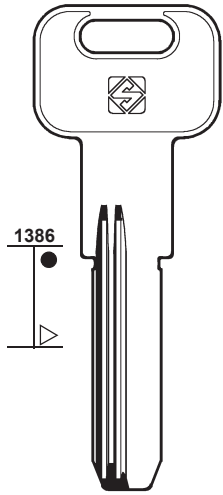

UC8R

URBIS

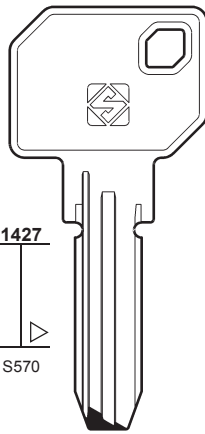

UB3

BSS - YALE

VACHETTE

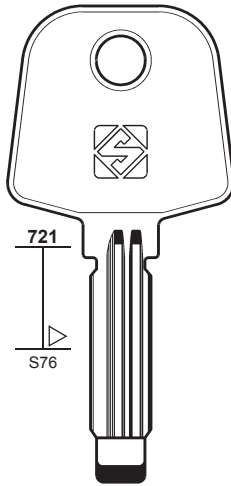

VAC91

RADIAL

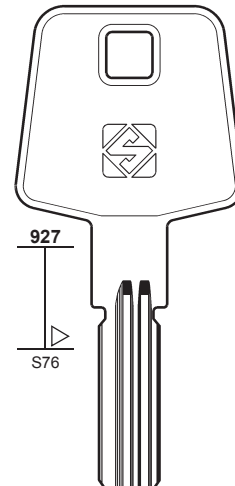

VAC103

VAC104

VAC105

RADIAL

PER:
FOR: **VACHETTE**

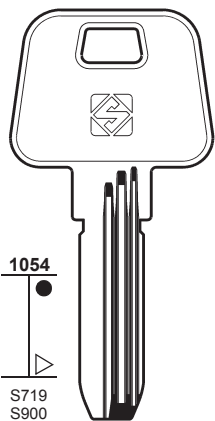

VAC150
V6

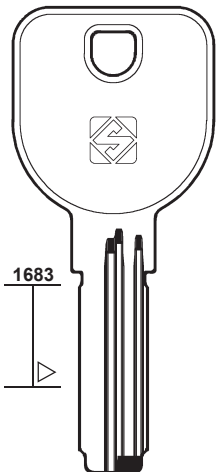

VAC152

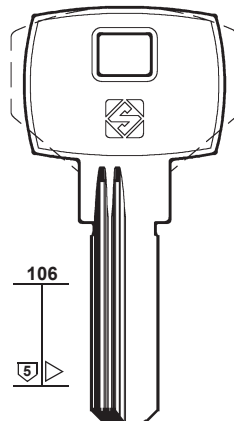

VAC153R

VANGUARD

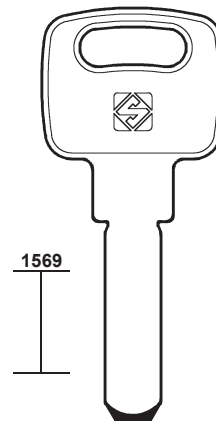

VGD1



248

PER / FOR

VBH (DE)
+ FCV (234)

VIDMAR (CH)
+ SEA (244)

VIRO (IT)
FEB
+ ELCA (232)
+ TESA (246)

WALLY (IT)

WANJIN (CN)
HOOPLY

WAUS (PL)

WILKA (DE)

YALE (GB) (IT)
+ URBIS (247)

YALTRES (AR)
+ FTH (234)

YARDENI (IL)

PER: FOR:	VBH	VIRO	WALLY	WANJIN
	 1590	 1434 6 S630	 1434	 1603 7
	 VBH1R	 VI19 EURO-PRO FEB	 WA8	 WJ1R HOOPLY

PER: FOR:	WAUS	WILKA	YALE	
	 1006 S753	 857 6+6 S621	 1584 6 S1345	 1584 10 S1346
	 WU1R	 WK70 10001-43000	 YA94 "1000 Series"	 YA95R "2000 Series"

PER: FOR:	YALE		YARDENI	
	 1584 6	 1584 6 S1071	 748	 1007 5+5 S78
	 YA99R IT	 YA90	 YD3R	 YD6R

PER:
FOR:

YARDENI

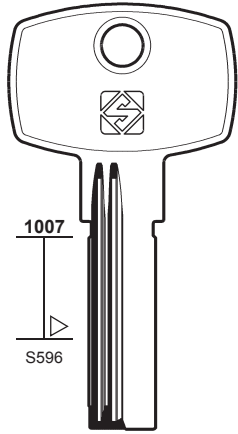

YD7R

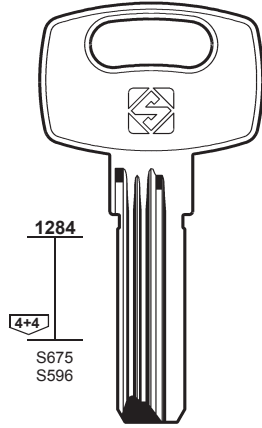

YD13R
XL
YD14R
6

ZADI

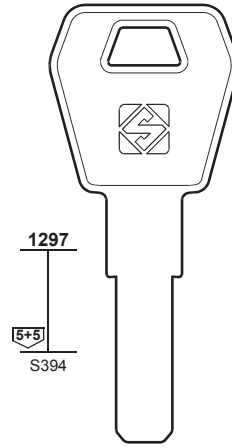

ZD25
BULLOCK

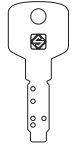

249

PER / FOR

YARDENI (IL)

YEMAR (ES)
UCEM (247)

YETI (PL)
MCM (240)

ZADI (IT)
BULLOCK

ZHONGHENG (CN)

PER:
FOR:

ZHONGHENG

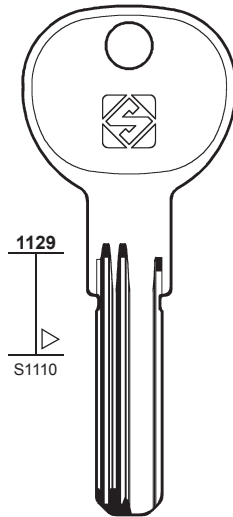

ZH1R

PER:
FOR:



Cruciform keys
Chiavi a croce
Kreuzschlüssel
Clés cruciformes
Llaves en cruz
Chaves tetra

PER:
FOR: **A.G.C.**

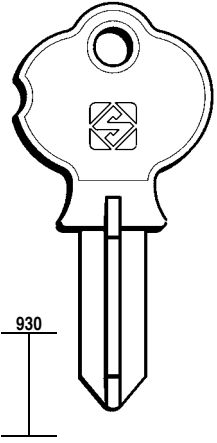

ALA

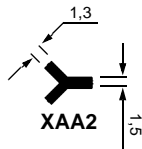
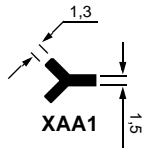
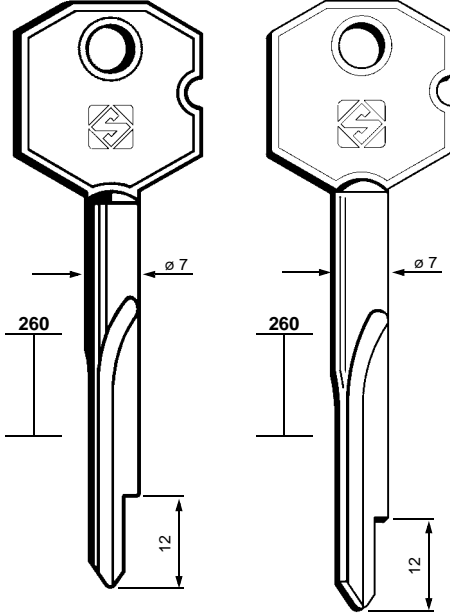

BLUMA

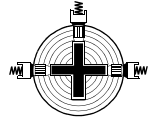
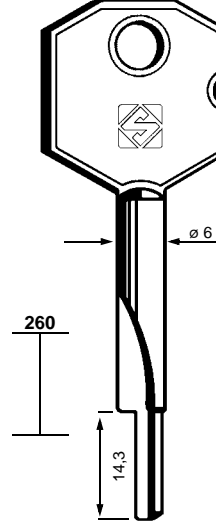

253

PER / FOR

A.G.C. (PT)

ALA (IT)

BKS (DE)

YALE (263)

BLUMA (DE)

BRASIL (BR)

BRYANSK (RU)

PER:
FOR: **BLUMA**

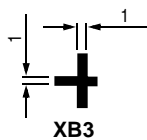
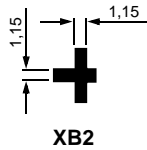
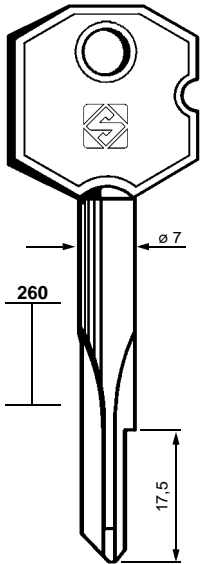

BRASIL

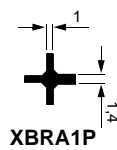
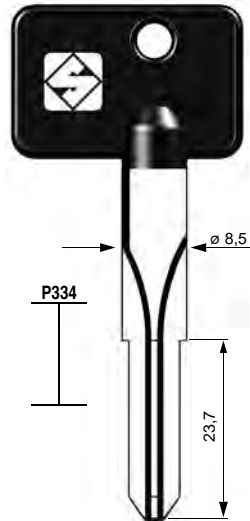

BRYANSK

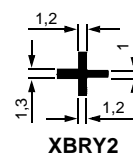
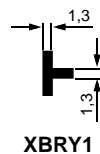
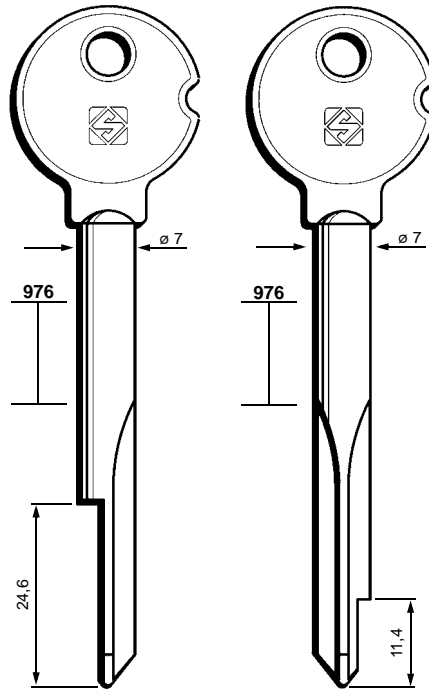

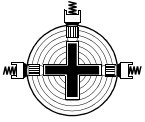

254

PER / FOR

BURG WÄCHTER (DE)
FIAM PRÄZIS
TRIOVING

PER:
FOR:

BURG WÄCHTER - Fiam Präzis

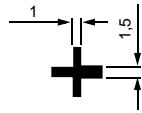
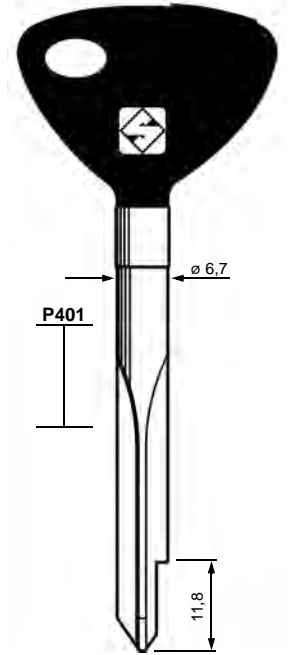
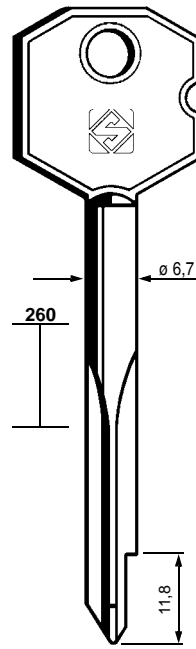
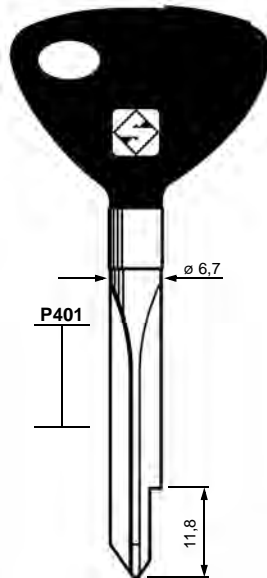
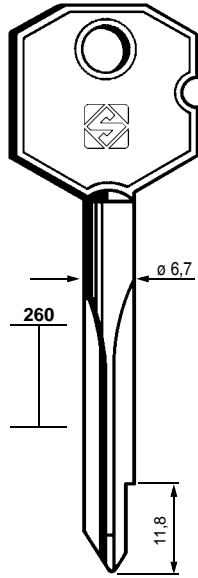

XBW1
mm 75

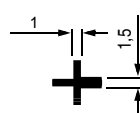

XBW1P
mm 75

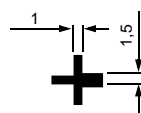

XBW2
mm 85

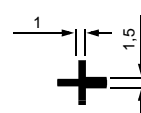

XBW2P
mm 85

TRIOVING

PER:
FOR:

BURG WÄCHTER - Fiam Präzis

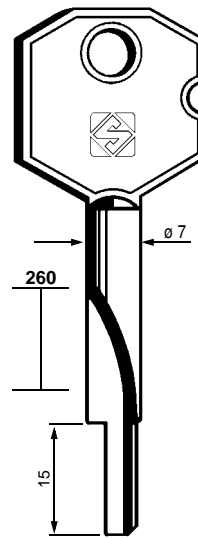
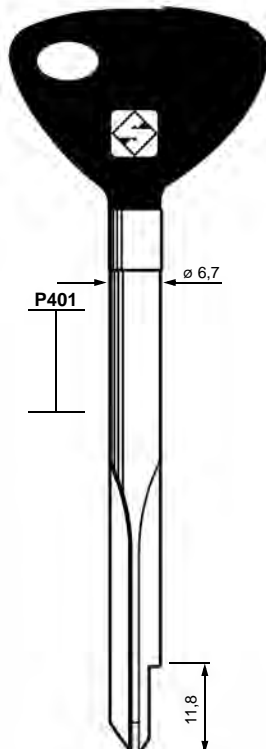
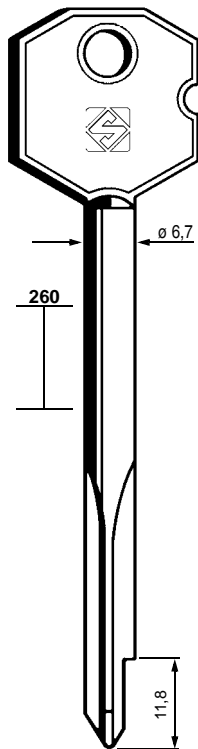

XBW4

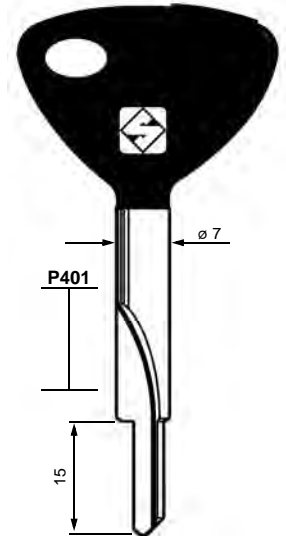

XBW4P

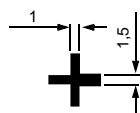

XBW3
mm 100

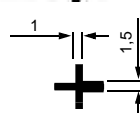

XBW3P
mm 100

PER:
FOR:

BURG WÄCHTER - Fiam Präzis

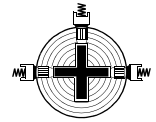

255

PER / FOR

BURG WÄCHTER (DE)
FIAM PRÄZIS

BRICARD (FR)

C.R. (IT)

YALE (263)

CCF (PT)

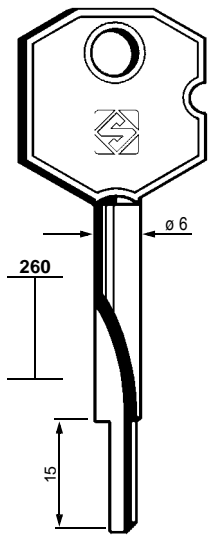

➔
XBW5

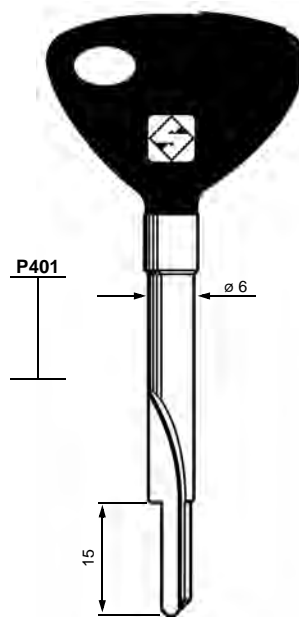

➔
XBW5P

PER:
FOR:

BRICARD

CCF

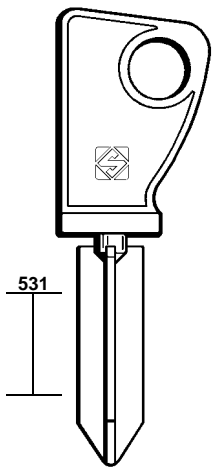

531

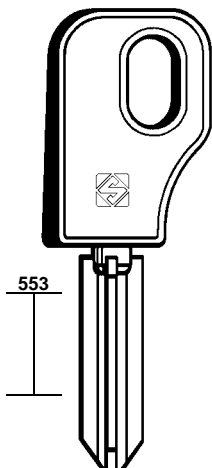

553

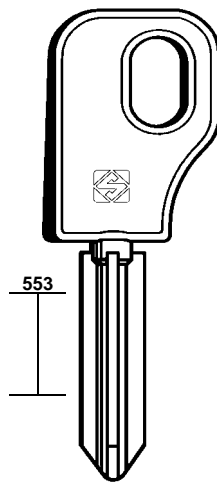

553

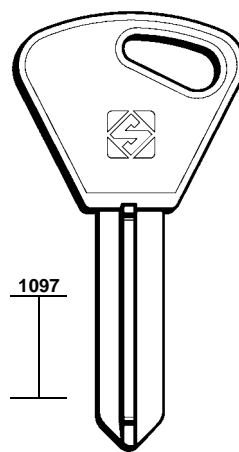

1097

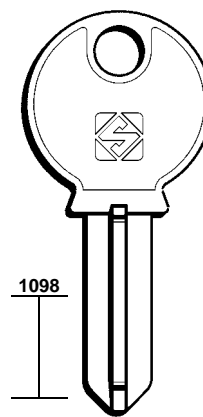

1098



XBD4



XBD5



XBD2



XBD3



XBD6



XBD1



XBD7



XCCF2
CCF5



XCCF3
CCF4

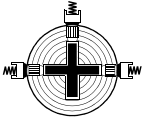

256

PER / FOR

CCF (PT)

CINA (CN)

CRC - CAMBOA (PT)

FAB (CZ)

PER:
FOR:

CCF

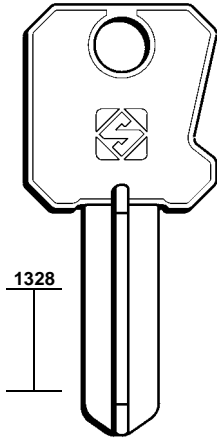

1328

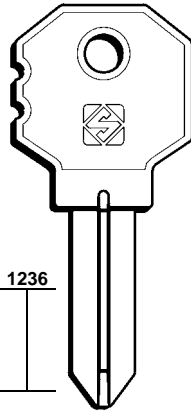

1236

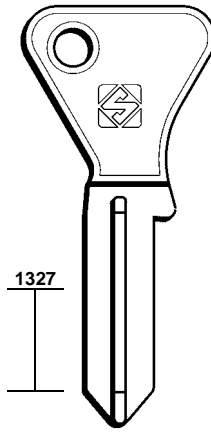

1327

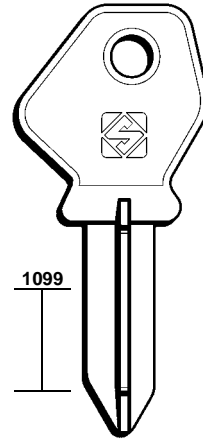

1099

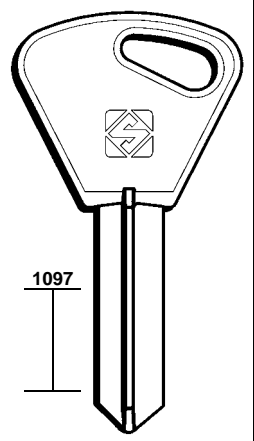

1097



XCCF6
CCF6



XCCF7
CCF7



XCCF8
CCF8



XCCF9
CCF9



XCCF10
CCF10

PER:
FOR:

CINA

CRC-CAMBOA

FAB

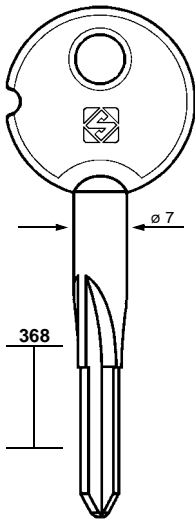

368

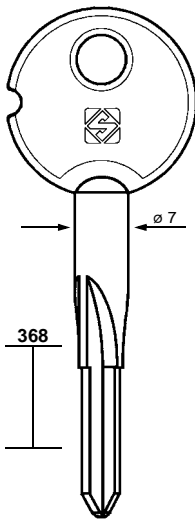

368



XRC1

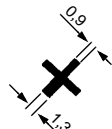

XRC2

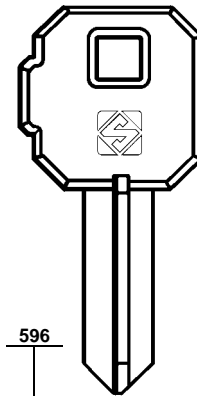

596



XC1

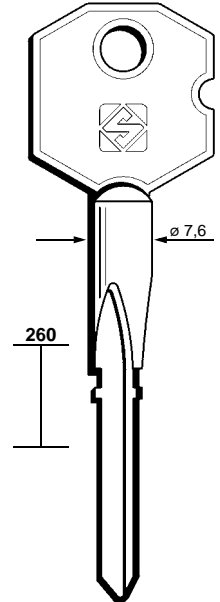

260

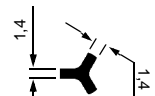

XFB1

PER:
FOR:

FAB

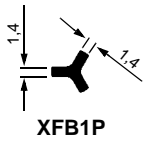
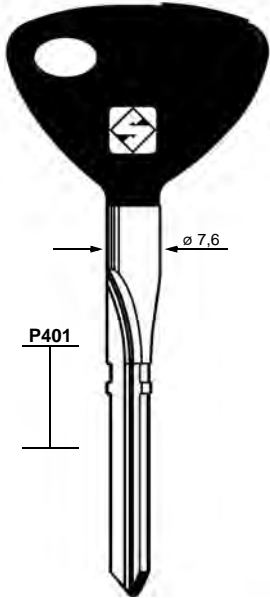

FIAM

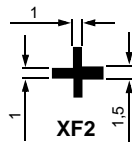
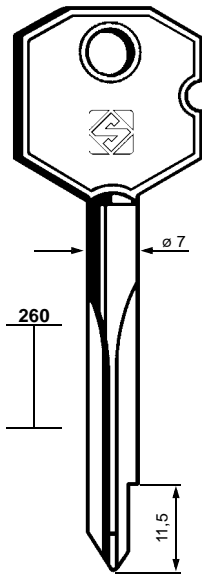
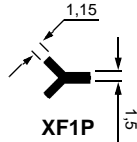
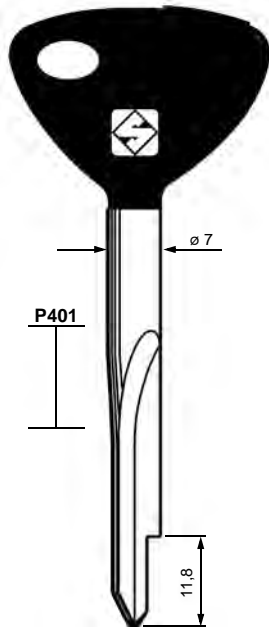

KALE

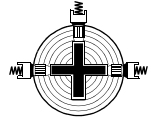
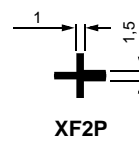
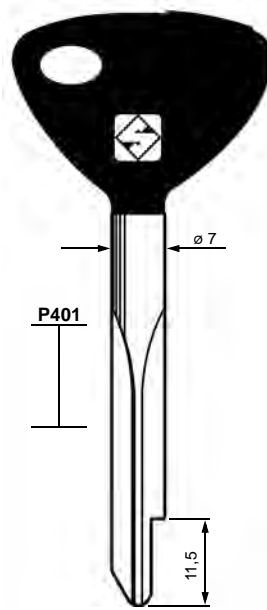

257

PER / FOR

FAB (CZ)

FIAM (IT)

KALE

+ YALE (263)

FIAM PRÄZIS (IT)

+ BURGWÄCHTER

(254-255)

+ YALE (263)

FRIPA (DE)

GERA (DE)

G.R. (FR)

(GUERVILLE RIQUIER)

PER:
FOR:

FRIPA

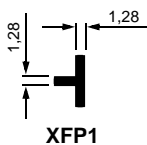
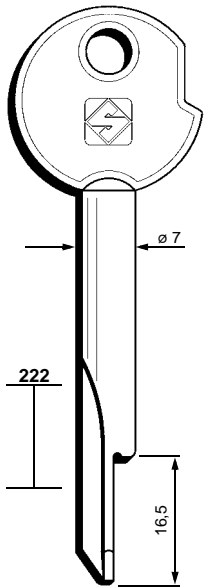

G.R.

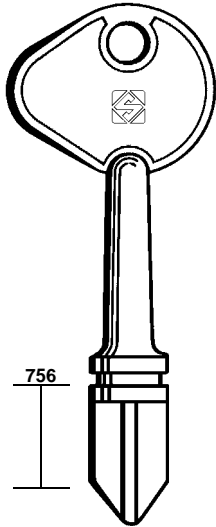

GUERVILLE-RIQUIER

GERA

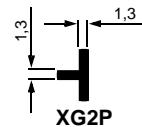
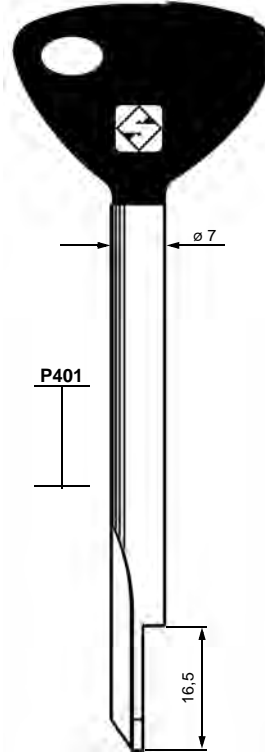
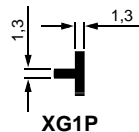
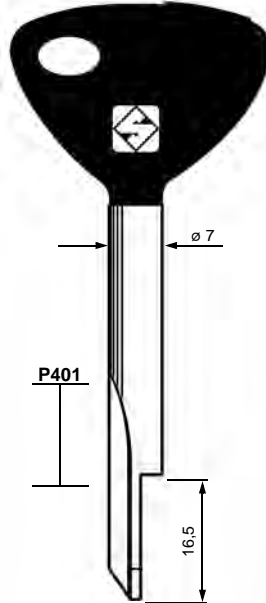

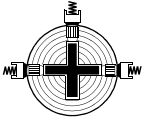

258

PER / FOR

HELCO - KFV (DE)

ISEO (IT)

KALE (TR)

FIAM (257)

PER:
FOR:

HELCO - KFV

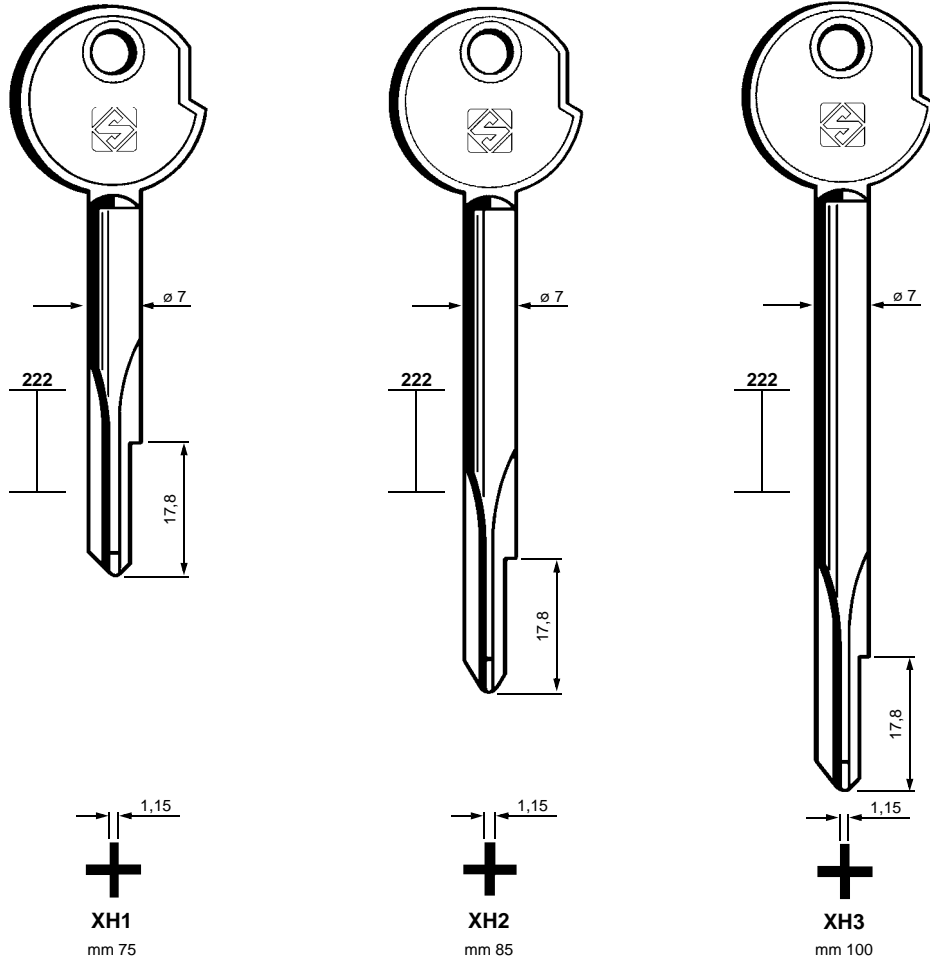

PER:
FOR:

ISEO

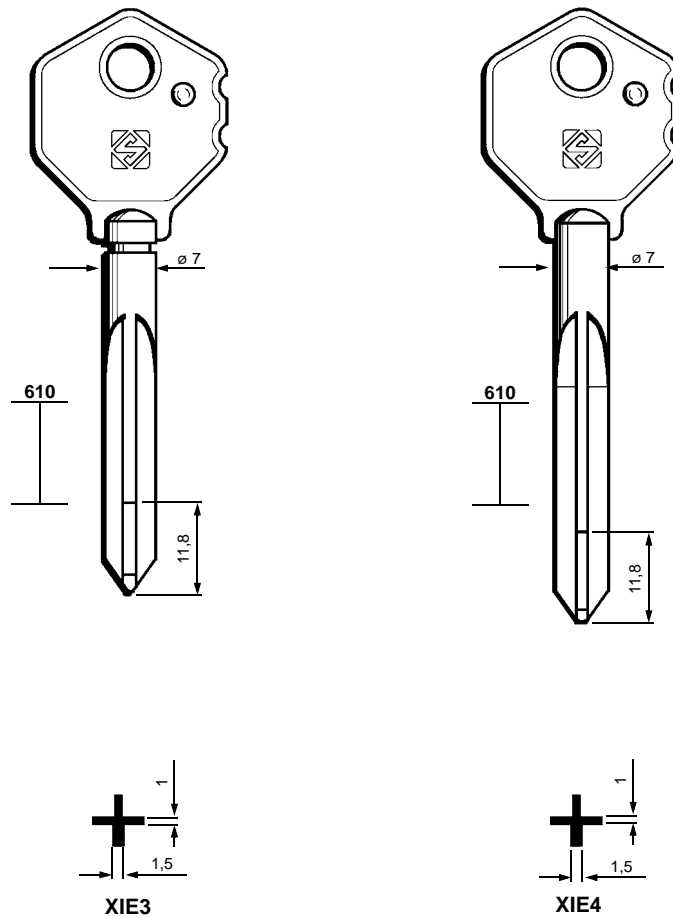

PER:
FOR:

KIROV

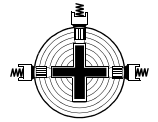

259

PER / FOR

KIROV (RU)

LIPS (NL)

ZEISS - IKON (266)

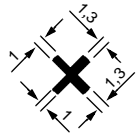
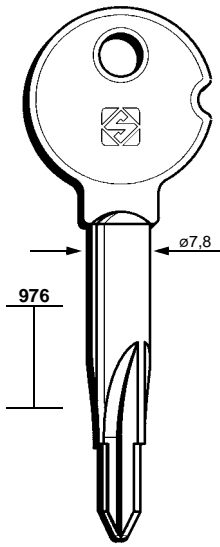

XKV11

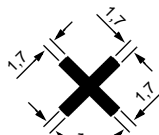
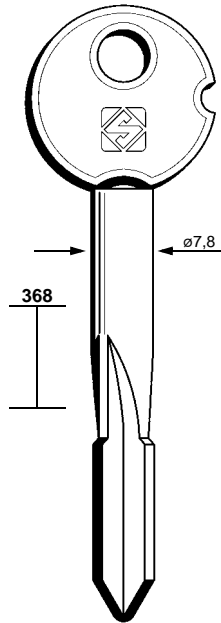

XKV6

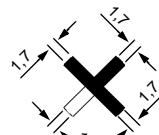
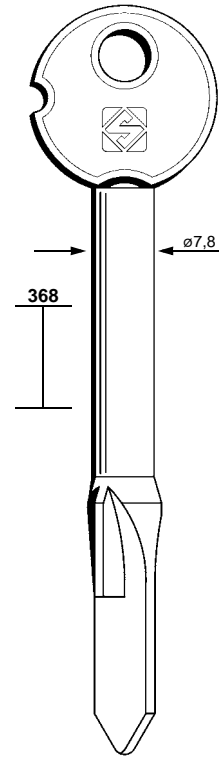

XKV8

PER:
FOR:

KIROV

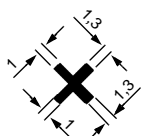
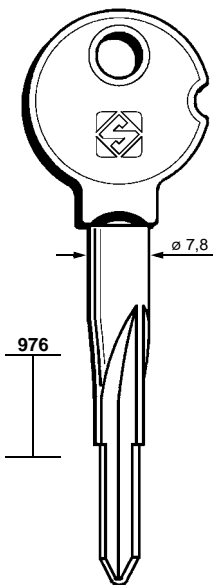

XKV2

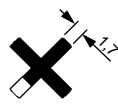
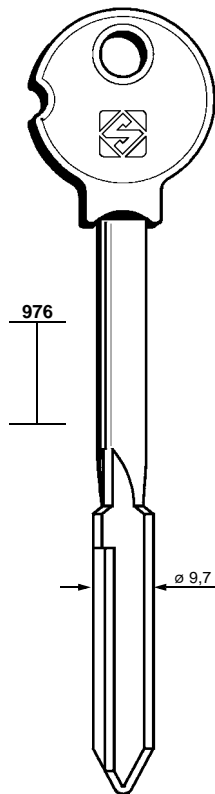

XKV7

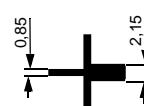
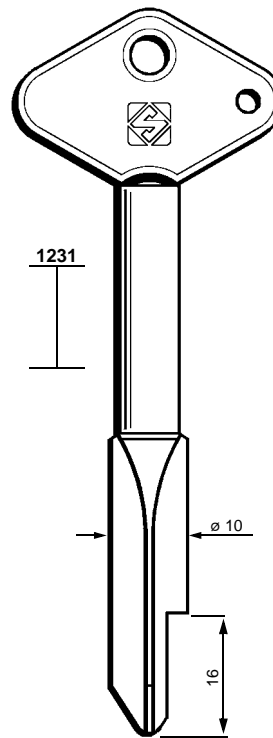

XKV10

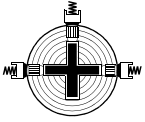

260

PER / FOR

MAFOR (FR)
RONIS
SOS

MOBELLA (SE)

MOREAUX (FR)

NABOB (IL)

PER:
FOR:

MAFOR

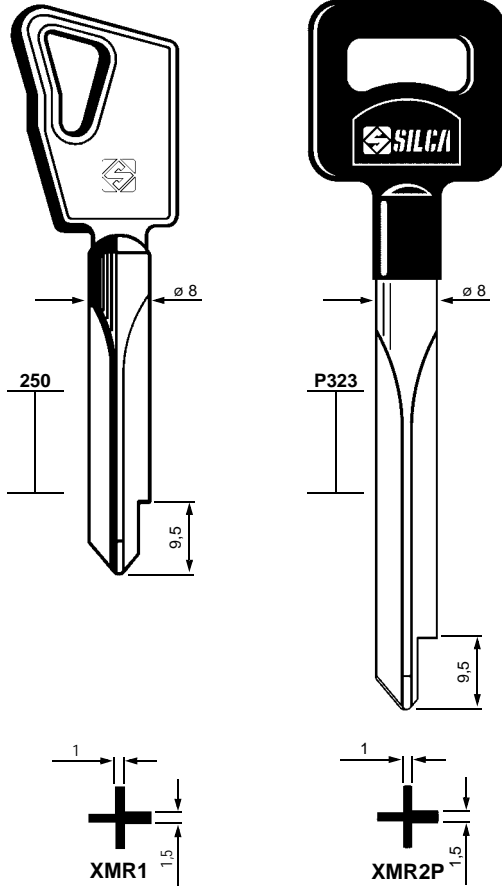

RONIS - SOS

MOBELLA

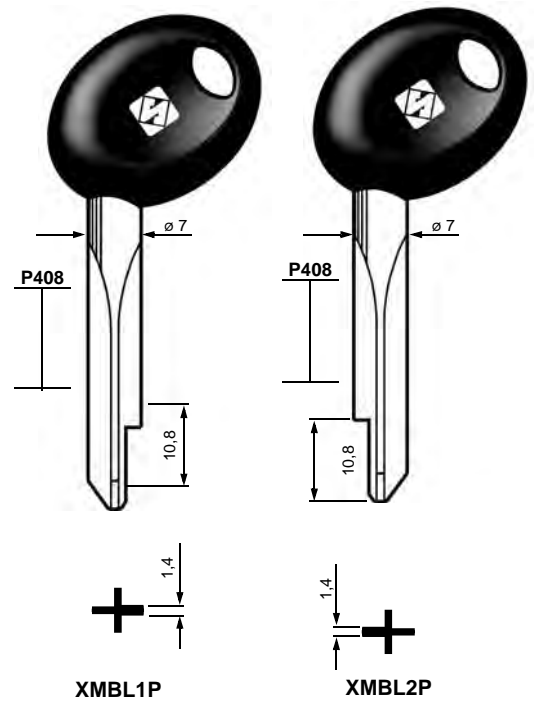

PER:
FOR:

MOREAUX

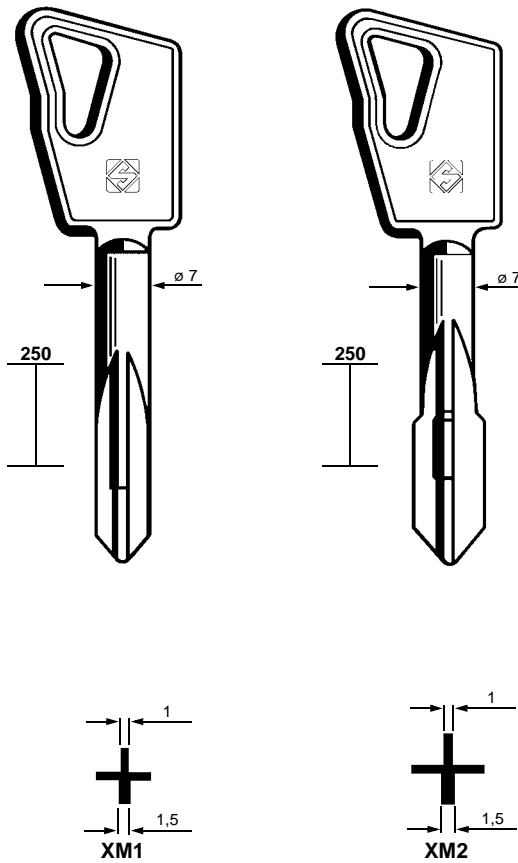

NABOB

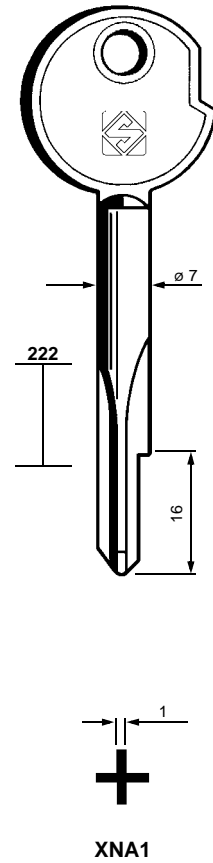

PER:
FOR:

NEMEF

OMEC

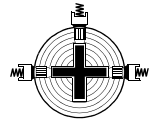

261

PER / FOR

NEMEF (NL)

OMEC (IT)

PADO (BR)

PAPAIZ (BR)

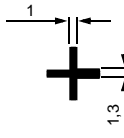
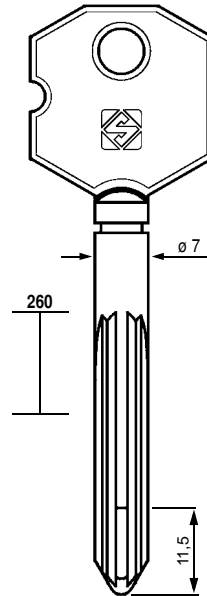
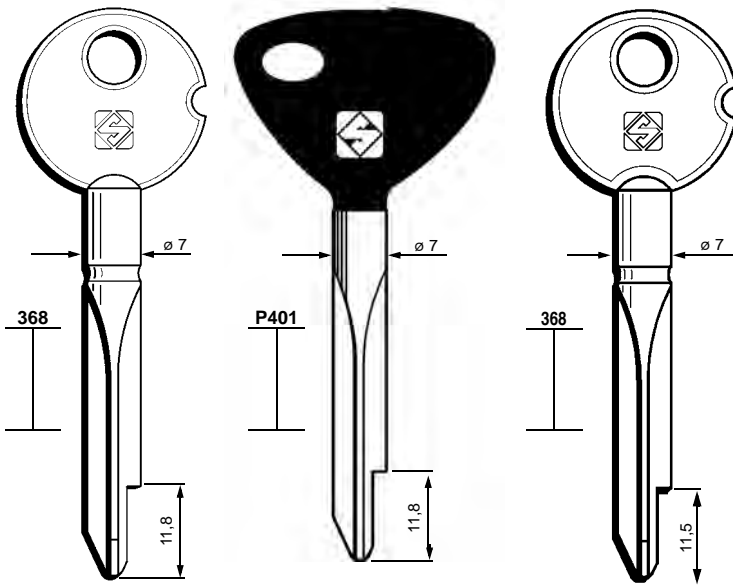

XN1

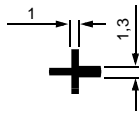

XN1P

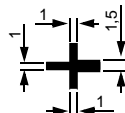

XN3



XOC1

PER:
FOR:

PADO

PAPAIZ

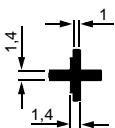
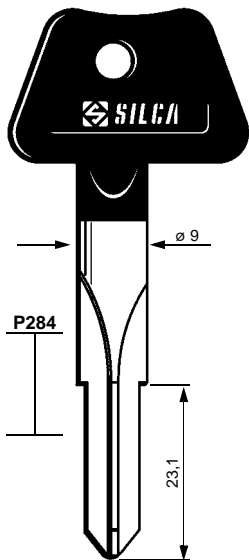

XPDO1P

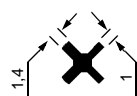
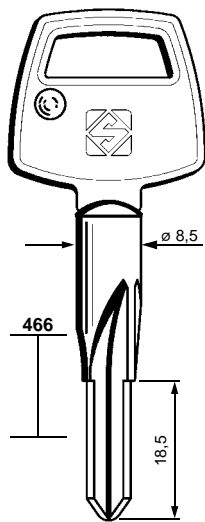

XPZ1

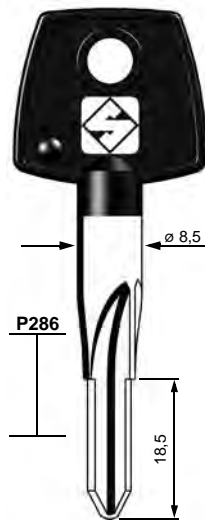

XPZ1P

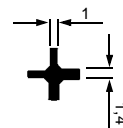
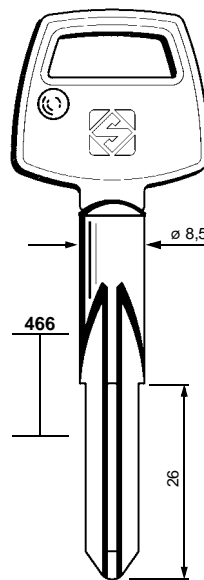

XPZ2

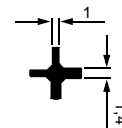
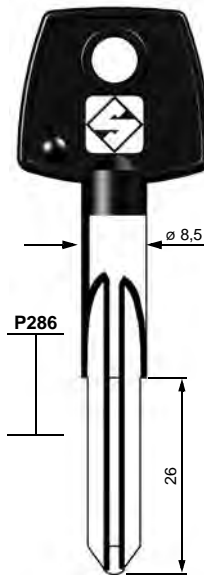

XPZ2P

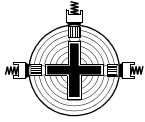

262

PER / FOR

PUNKT (DE)

RONIS (FR)

MAFOR (260)

SELMACH (RU)

STAM (BR)

SOS (FR)

MAFOR (260)

TRIOVING (SE)

BÜRG WÄCHTER (254)

TUFF (HK)

PER: PUNKT

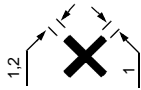
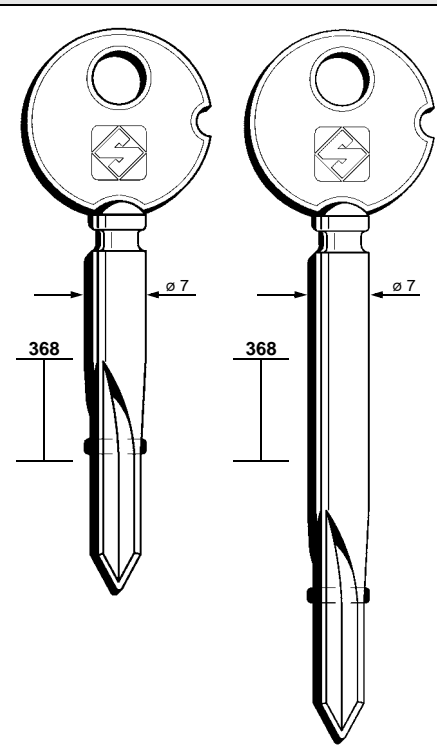

XPK1

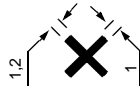

XPK2

PER: SELMACH

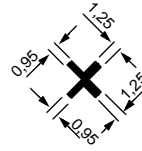
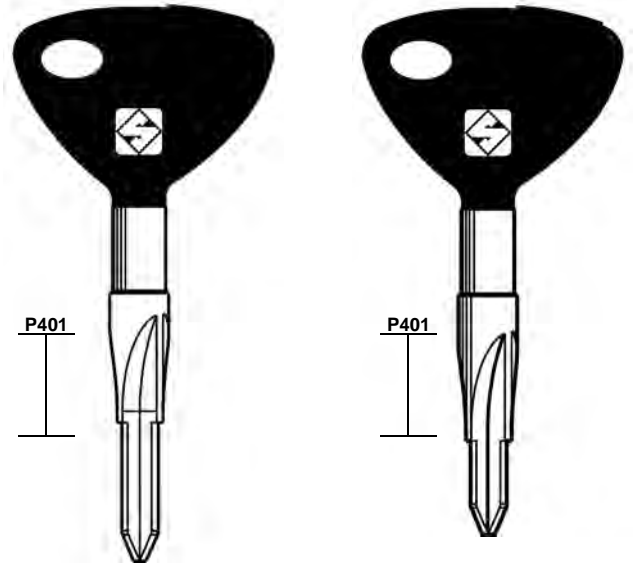

XSLH1P

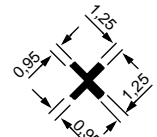

XSLH2P

PER: STAM

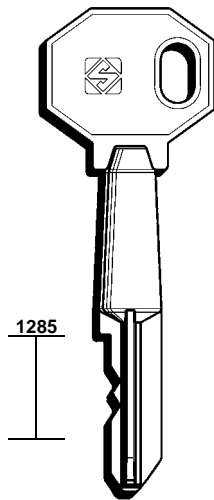

XSAM3

PER: TUFF

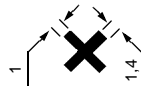
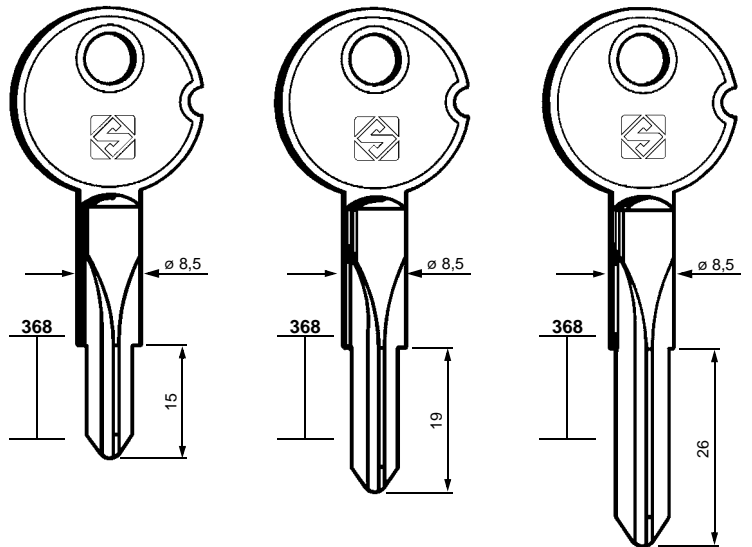

XTF1

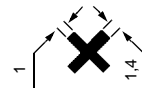

XTF2



XTF3

PER:
FOR:

YALE - BKS

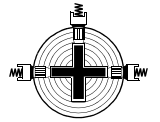

263

PER / FOR

YALE (DE)
BKS

YALE (IT)
C.R.
FIAM PRÄZIS

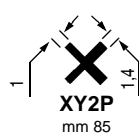
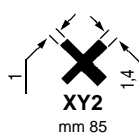
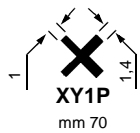
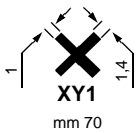
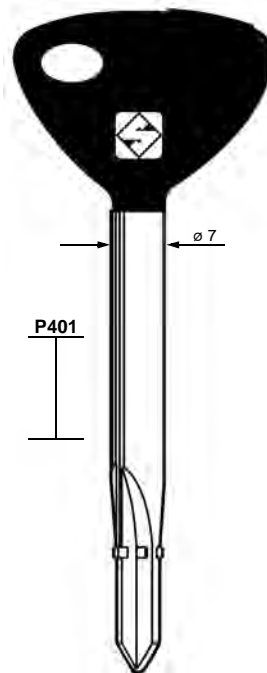
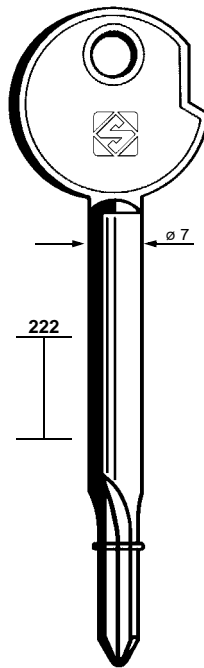
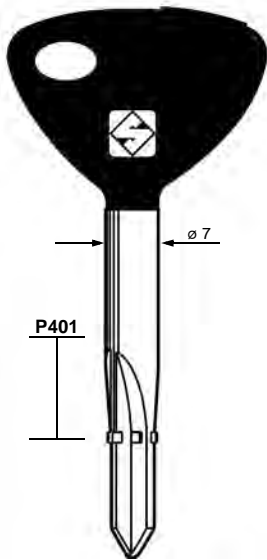
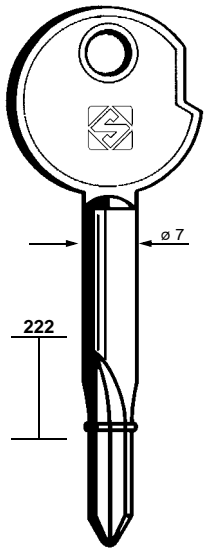

BKS

BKS

PER: **YALE - BKS**

YALE **I**

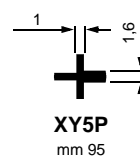
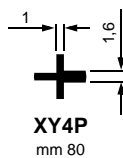
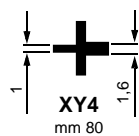
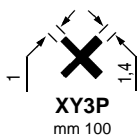
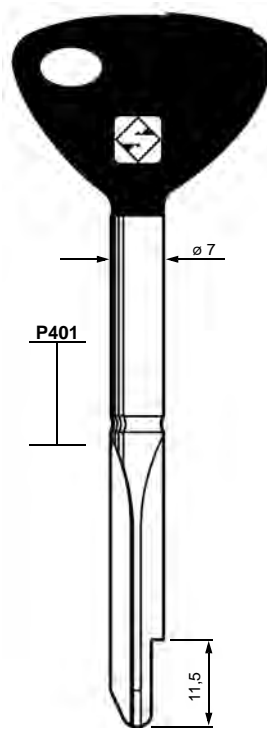
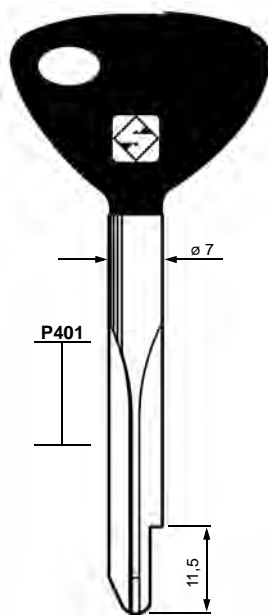
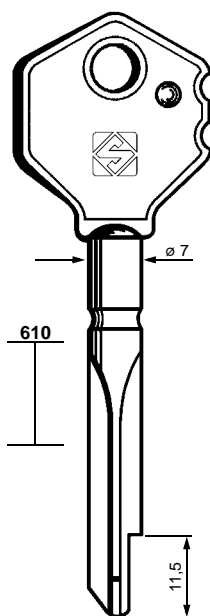
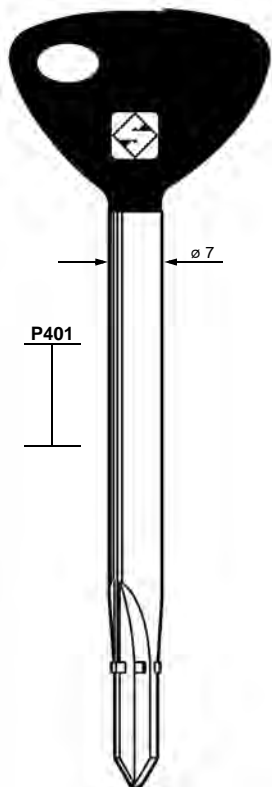

C.R. - FIAM PRÄZIS

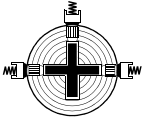

264

PER / FOR

YALE (IT)

YALTRES (AR)

ZASO (TW)

PER:
FOR:

YALE I

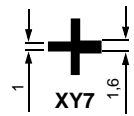
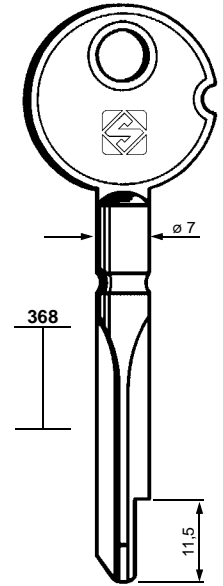
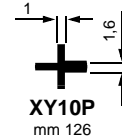
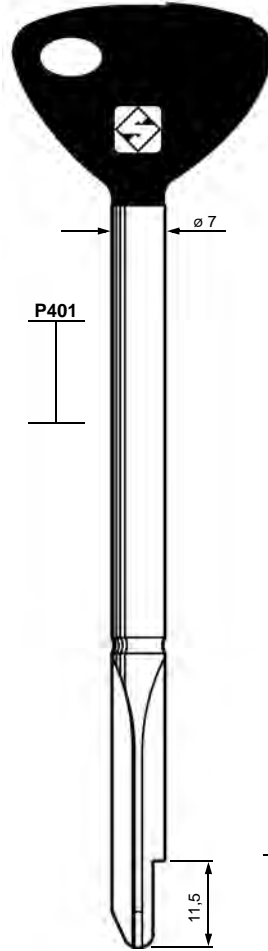
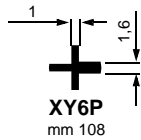
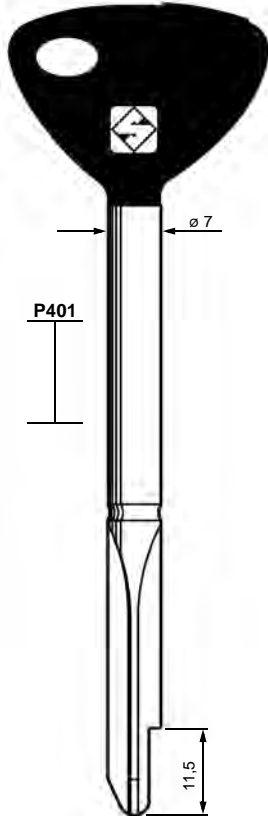

PER:
FOR:

YALTRES

ZASO

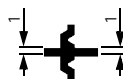
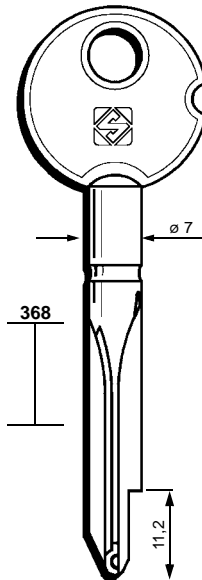
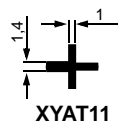
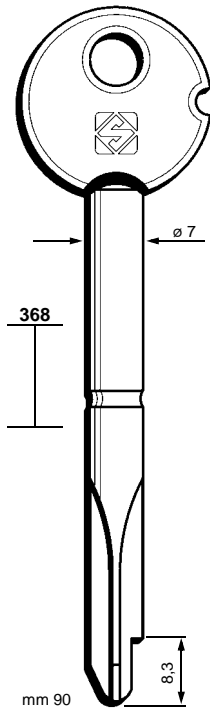

XZAS1

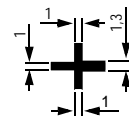
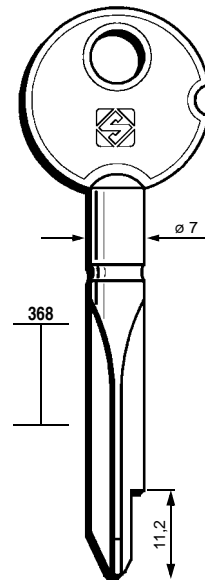

XZAS2

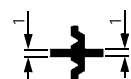
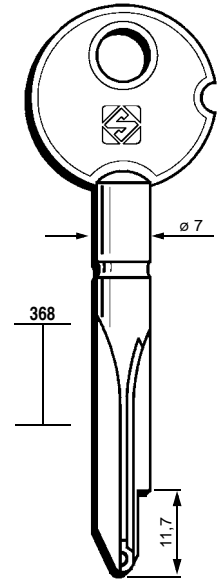

XZAS3

PER:
FOR:

ZEISS - IKON

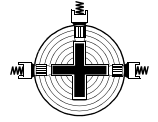

265

PER / FOR

ZEISS - IKON (DE)

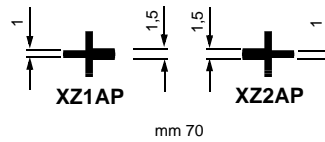
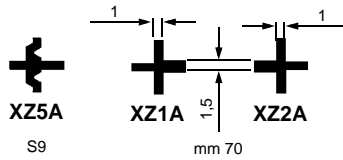
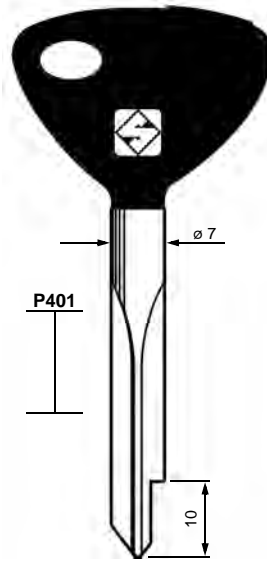
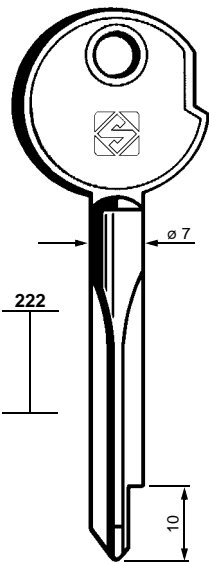

PER:
FOR:

ZEISS - IKON

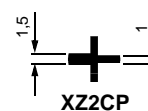
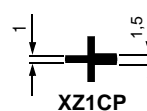
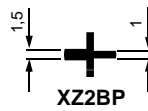
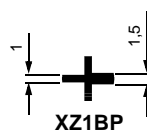
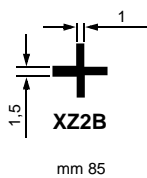
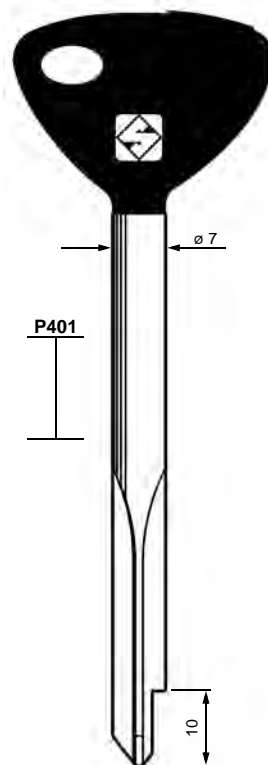
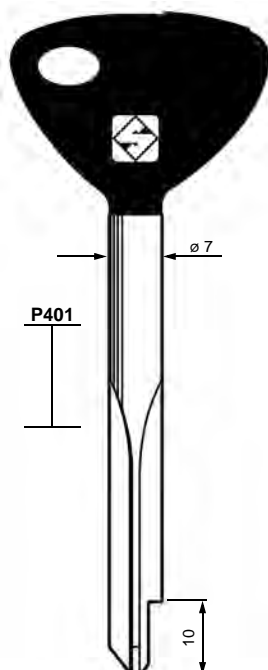
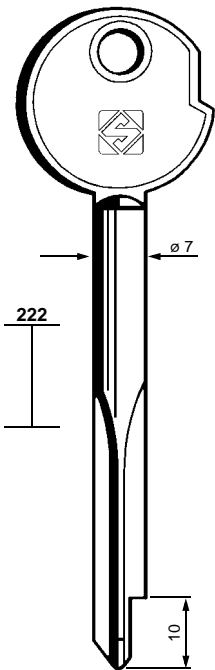

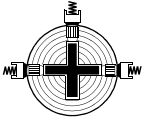

266

PER / FOR

ZEISS - IKON (DE)
LIPS

PER:
FOR:

ZEISS - IKON

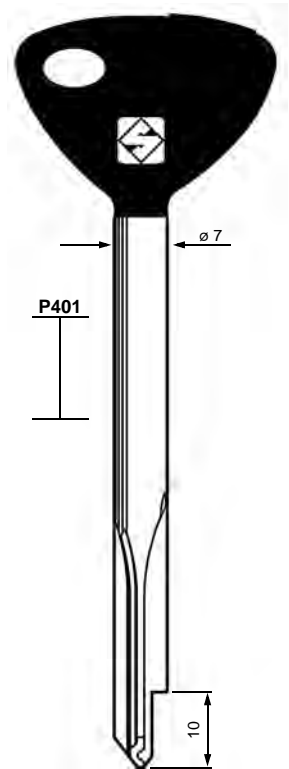
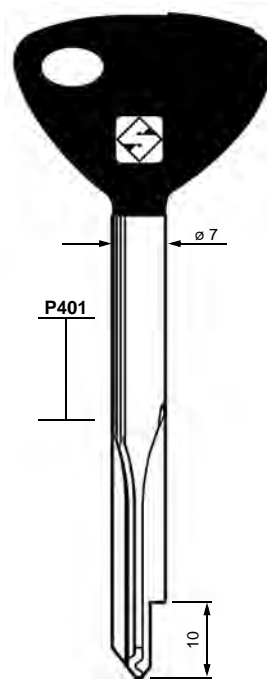
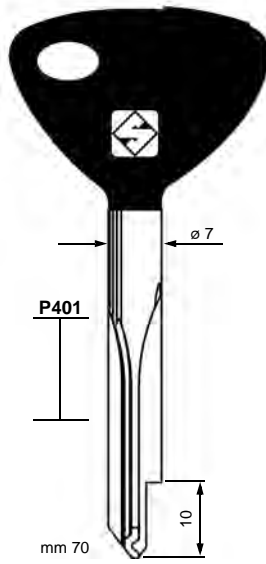
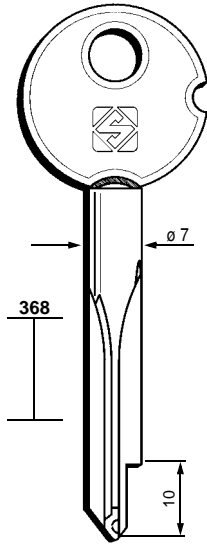

XZ3A
S9
mm 70

LIPS



XZ3AP
S9

LIPS



XZ6AP
VS9



XZ3BP
S9
mm 85



XZ3CP
S9
mm 100

PER:
FOR:



Mail box and lift keys
Chiavi per casellari e ascensori
Fachkästen-und Liftschlüssel
Clés pour casiers et ascenseurs
Llaves para casillas y ascensores
Chaves para caixas de correio e elevadores

PER:
FOR:



269

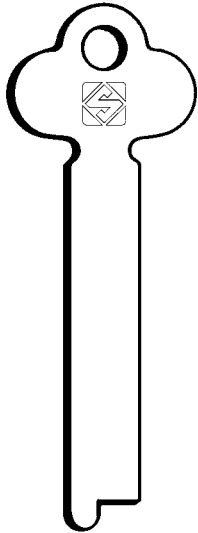

1001

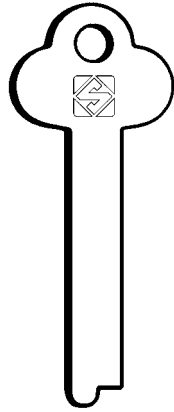

1000

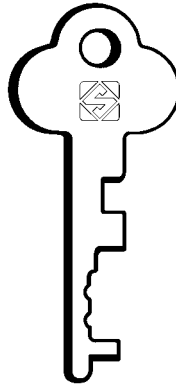

1003P

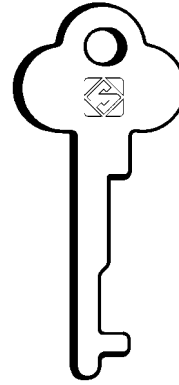

1003P1

PER / FOR

CISA (IT)

I.B.F.M (IT)

J.BEER (GB)
YALE (269)

MILES (RU)

RIL (PT)

SARGENT (US)

SERRETA (ES)

UNION (GB)

YALE (GB)
J. BEER

PER:
FOR: CISA

I.B.F.M

MILES

RIL

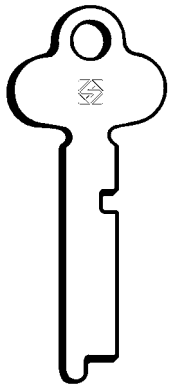

CS1003

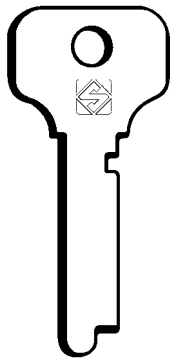

1002

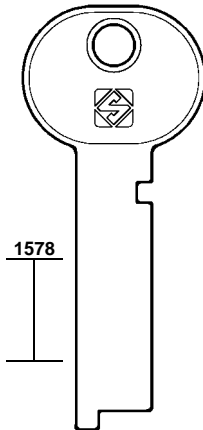

MIS1

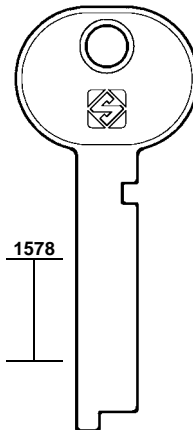

MIS2

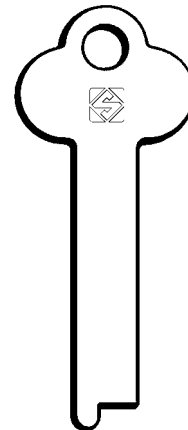

RL1

PER:
FOR: SARGENT

SERRETA

UNION

YALE

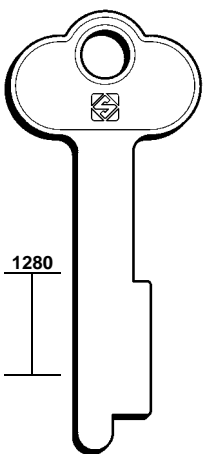

SAR1031

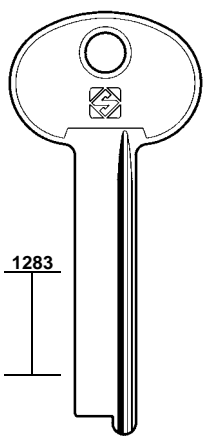

SAR1032

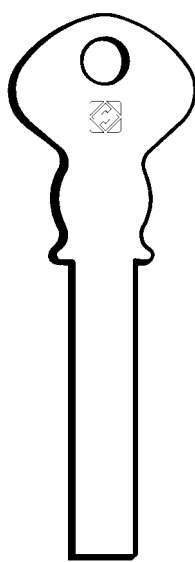

CX7

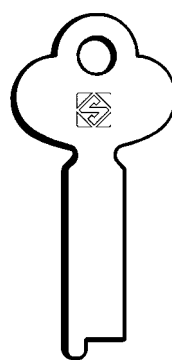

UNI1010

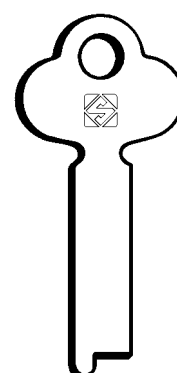

YA1007

J. BEER



270

PER / FOR

CASELLARIO (IT)

COUILLET (FR)

CUIRASSEE (FR)

PER:
FOR:

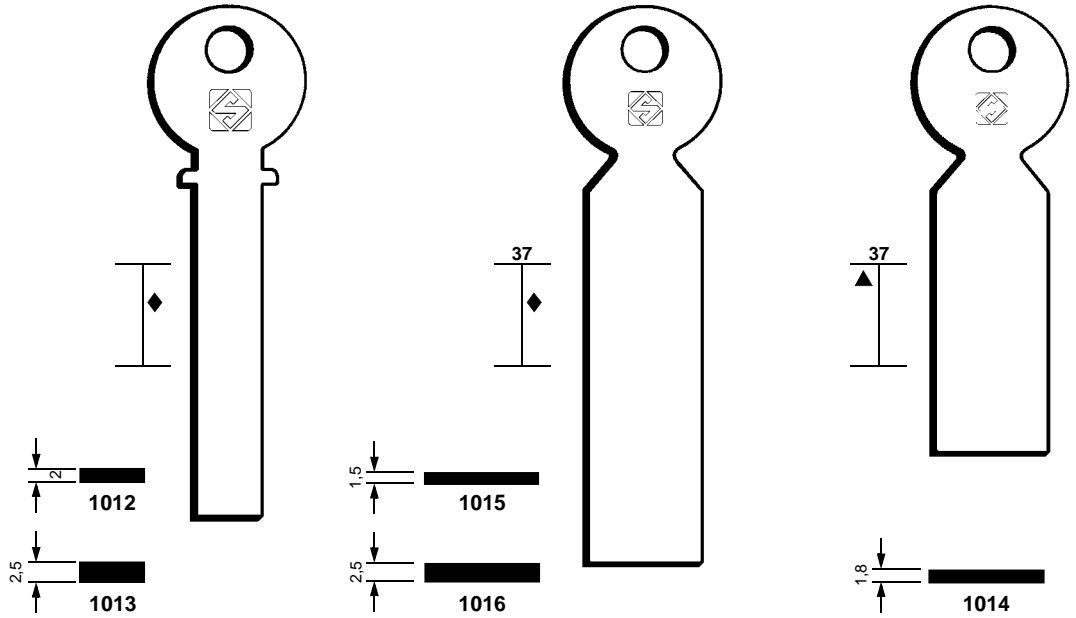

PER:
FOR:

COUILLET

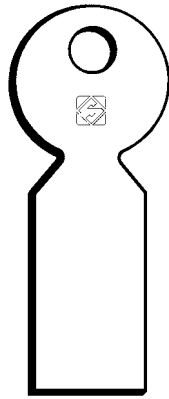

- | | | | |
|--|-------|--|-------|
| | CU401 | | CU409 |
| | CU402 | | CU410 |
| | CU403 | | CU411 |
| | CU404 | | CU412 |
| | CU405 | | CU413 |
| | CU406 | | |
| | CU407 | | |
| | CU408 | | |

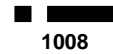
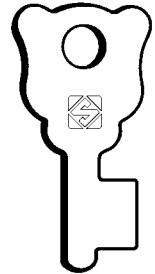
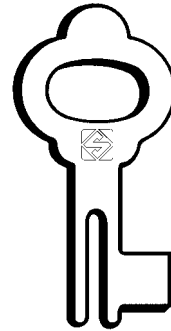

1008



1009

PER:
FOR:

CASELLARIO

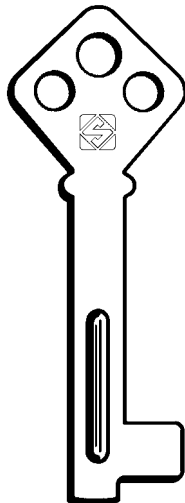

- | | |
|--|---------------|
| | 1004 |
| | Right/Destro |
| | 1005 |
| | Left/Sinistro |

CUIRASSEE

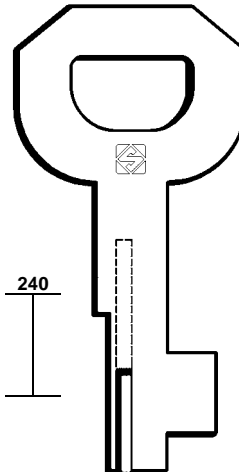

240

- | | |
|--|--------|
| | CRE401 |
| | CRE402 |
| | CRE403 |

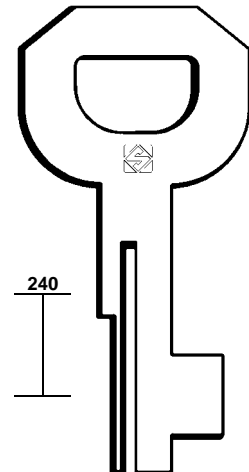

240

- | | |
|--|--------|
| | CRE404 |
| | CRE405 |
| | CRE406 |

PER:
FOR:

MOBELLAS

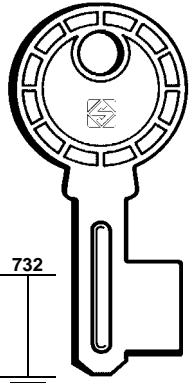

MBS300

- (SER11) 22001-22750
- (SER12) 17501-18250
- (SER13) 16001-16750
- (SER14) 18251-19000
- (SER15) 16751-17500
- (SER21) 11501-12250
- (SER22) 24251-25000
- (SER23) 10751-11500
- (SER24) 12251-13000
- (SER25) 10001-10750
- 1-2-3-4-5
- 1-2-3-4-5

MBS301

- (SER11) 40751-41500
- (SER12) 36251-37000
- (SER13) 34751-35500
- (SER14) 37001-37750
- (SER15) 35501-36250
- (SER21) 30251-31000
- (SER22) 43001-43750
- (SER23) 29501-30250
- (SER24) 31001-31750
- (SER25) 28751-29500
- 1-2-3-4-5
- 1-2-3-4-5

MUEL

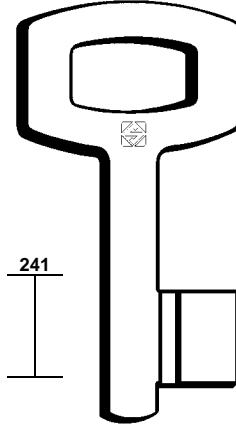

MU401

MU402

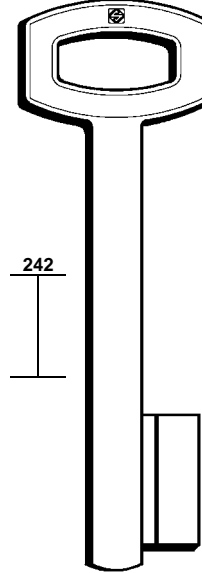

MU403

MU404

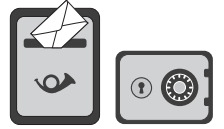

271

PER / FOR

MOBELLAS (SE)

MUEL (FR)

BODE (DE)

HEERUM (DE)

KROMA (DE)
OSTERTAG (271)

OSTERTAG (DE)
KROMA

STUV (DE)

PER:
FOR:

BODE

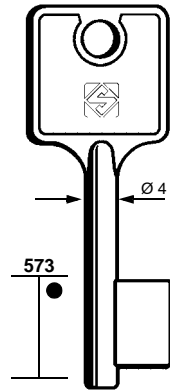

6BDE1

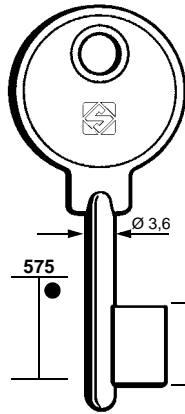

6BDE2

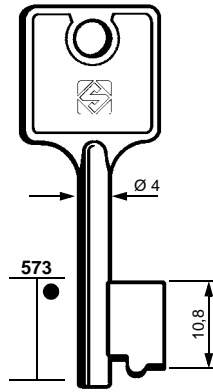

6BDE3

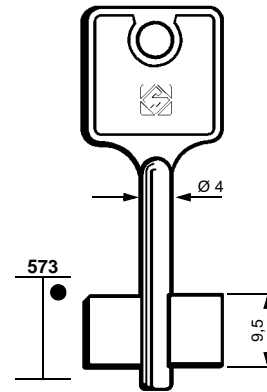

5BDE1

PER:
FOR:

HEERUM

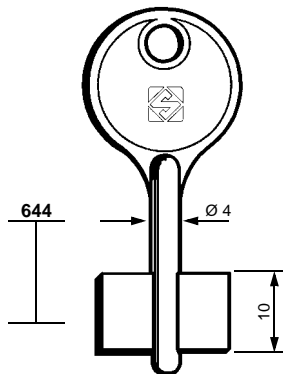

5HRM1

OSTERTAG

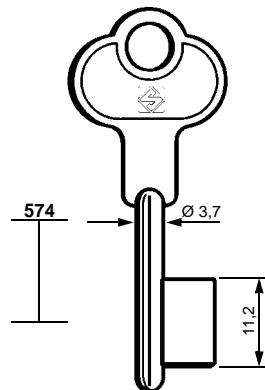

6OG1

KROMA

STUV

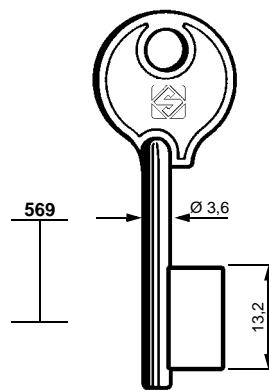

6SV1



272

PER / FOR

BASSETTI (IT)

BELLOMO (IT)

STIGLER (273)

BONFEDI (IT)

BOSISIO (IT)

FALCONE (IT)

FIAM (IT)

INSUBRIA (IT)

PER:
FOR:

BASSETTI

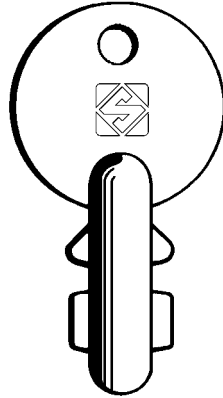

ABA1

BONFEDI

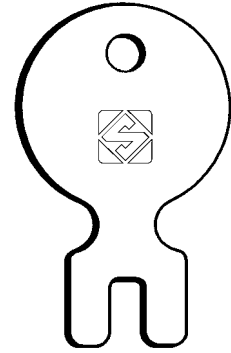

ABO1
Modified/Modificato

PER:
FOR:

BONFEDI

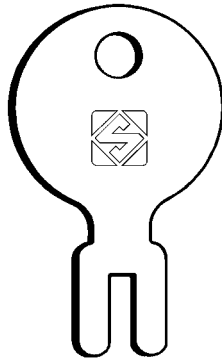

ABO2
Normal/Normale

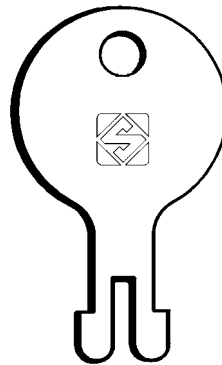

ABO3
To cut out/Ritagliato

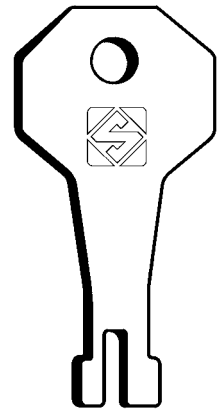

ABO4

PER:
FOR:

BOSISIO

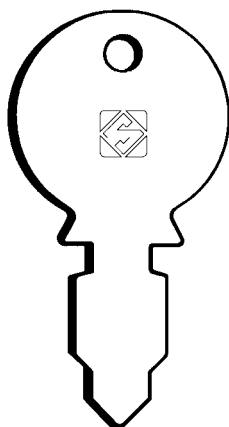

ABOS1

FALCONE

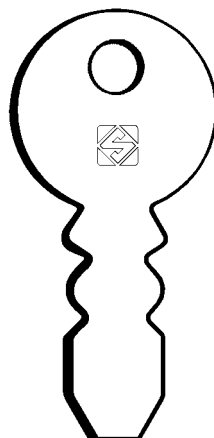

AFA1

FIAM

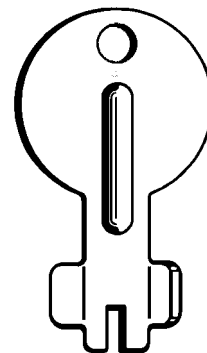

AF1
Universal/Universale

INSUBRIA

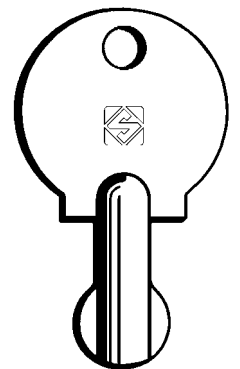

AIN1

PER:
FOR: **MANETTI**

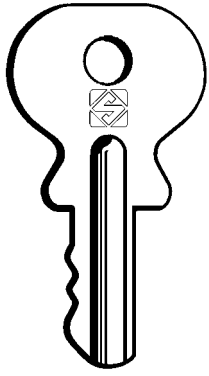

AMA1

PERINO

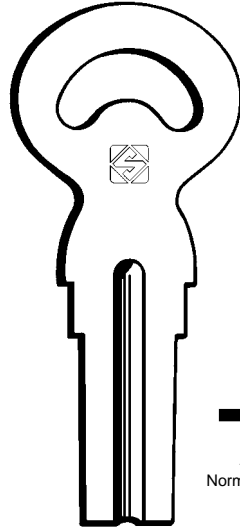

APE1
Normal/Normale



APE2

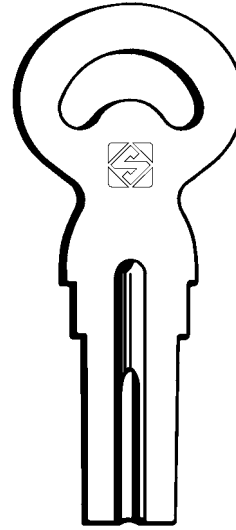

APE1F



273

PER / FOR

MANETTI (IT)

PERINO (IT)

ROMA (IT)

SABIEM (IT)

SAFOV (IT)

S.I.C.E.M. (IT)

STIGLER (IT)
BELLOMO

PER:
FOR: **ROMA**

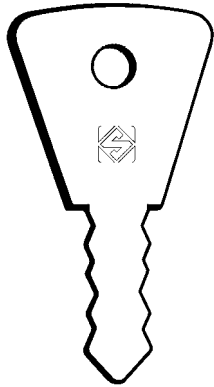

ARO1

SABIEM

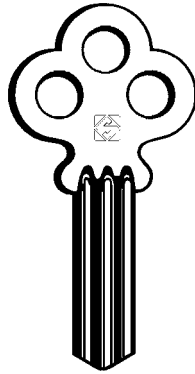

ASAB1

SAFOV

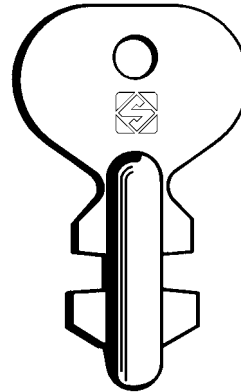

ASAF1
Modified/Modificato

PER:
FOR: **S.I.C.E.M**

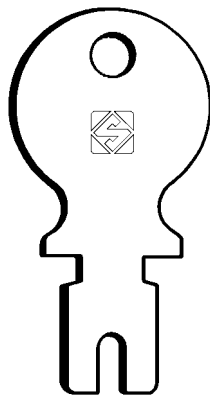

ASI1

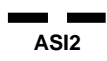

ASI2

STIGLER - BELLOMO

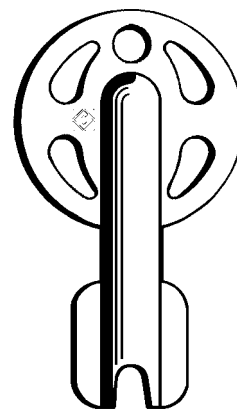

AST1



General index
Indice generale
Generalverzeichnis
Index général
Indice general
Índice geral

REF.		PAGE	REF.		PAGE	REF.		PAGE
1			AA5R	● ▲	14	AB23	▲	8-100
1000	◆	269	AA6	● ▲	14	AB23R	● ▲	8-100
1001	◆	269	AA6R	● ▲	14	AB24	▲	8
1002	◆	269	AAA1	● ▲ U	4	AB25R	▲	6
1004	◆	270	AAB1	●	4	AB26	▲	6
1005	◆	270	AB1	● ▲ U	6	AB27	● ▲ U	8
1008	◆	270	AB1R	▲ U	7	AB29R	▲	8
1009	◆	270	AB1RX	▲	7	AB30	● ▲	8
1012	◆	269	AB1X	● ▲ U G S	7	AB30R	● ▲	8
1013	◆	269	AB2	● ▲	7	AB31	▲	8
1014	◆	269	AB2R	● ▲	7	AB32	● ■	6
1015	◆	269	AB3	● ▲	7	AB33	▲	6
1016	◆	269	AB3R	● ▲	7	AB34	▲	6
1003P	◆	269	AB4	▲	7	AB35	▲	8
1003P1	◆	269	AB5	● ▲	7	AB35R	● ▲	8
4			AB6	▲	7	AB36	▲	6
454	● ▲	54	AB7	● ▲	7	AB36R	▲	6
5			AB8	▲	6	AB37	▲	6
5BDE1	●	270	AB8R	▲	6	AB37R	● ▲	6
5HRM1	●	270	AB9	● ▲	7	AB38P	● ■	6
6			AB10	● ▲	6	AB39	▲	8
6BDE1	●	270	AB10R	● ▲	6	AB39R	▲	8
6BDE2	●	270	AB11	● ▲	7	AB40	● ▲	10-225
6BDE3	●	270	AB11R	● ▲	7	AB41R	● ▲	8
6OG1	●	270	AB12	● ▲	8	AB42R	▲	6
6SV1	●	270	AB12R	● ▲	8	AB43	● ▲	8
A			AB13	● ▲	8	AB43R	● ▲	8
A303	● ▲	54	AB13R	▲	8	AB44	● ▲	6
AA1	● ▲	14	AB14	● ▲ U	7	AB44R	● ▲	6
AA1R	● ▲	14	AB14R	● ▲	7	AB45	● ▲	8
AA2	●	14	AB15	▲	8	AB46	▲	9
AA2R	●	14	AB15R	● ▲	8	AB47R	▲	6
AA3	●	14	AB16	● ▲	8	AB48	● S	10-225
AA3R	●	14	AB16R	● ▲	8	AB50	● ▲	9
AA4	● ▲	14	AB17	● ▲	8	AB51	▲	9
AA4R	● ▲	14	AB17R	● ▲	8	AB52	● ▲	9
AA5	● ▲	14	AB18	● ▲	7	AB53	● ▲	9
			AB19	● ▲ U	7	AB54	● ▲	9
			AB20	▲	7	AB55X	▲	7
			AB21	▲	6	AB56	▲	9
			AB21R	▲	6	AB56AP	▲	9
			AB22	▲	6	AB56R	▲	9

● Brass
Ottone
Messing
Laiton
Latón
Latão

▲ Steel
Acciaio
Stahl
Acier
Acero
Aço

■ Nickel silver
Alpacca
Neusilber
Maillechort
Alpaca
Alpaca

◆ Iron
Ferro
Eisen
Fer
Hierro
Ferro

Ⓒ Available in Color
Disponibile in Color
Lieferbar in Color
Disponibile en Color
Disponibile en Color
Disponível em Color

Ⓒ Available in Ultralite
Disponibile in Ultralite
Lieferbar in Ultralite
Disponibile en Ultralite
Disponibile en Ultralite
Disponível em Ultralite

Ⓒ Available in Silky
Disponibile in Silky
Lieferbar in Silky
Disponibile en Silky
Disponibile en Silky
Disponível em Silky

REF.		PAGE	REF.		PAGE	REF.		PAGE
AB57AP	▲	9	AB104R	●	6	AG9	▲	13
AB57RAP	▲	9	AB105R	▲	10	AG9R	▲	13
AB58AP	▲	9	AB109	●	10	AG10	●▲	13
AB58RAP	▲	9	ABA1	◆	270	AGA1	▲	11
AB59RAP	▲	9	ABO1	◆	270	AGA1R	▲	11
AB60P	●■	6	ABO2	◆	270	AGA2	▲	11
AB61	●	7	ABO3	◆	270	AGA2R	▲	11
AB62	●	10-225	ABO4	◆	270	AGA3	▲	11
AB63	●	6	ABOS1	◆	270	AGA4	▲	11
AB64RAP	●	9	AC1	▲	4	AGA4R	▲	11
AB65RAP	●	9	AC2	▲	4	AGA5	▲	11
AB66R	▲	10	ACR1	●▲U	17	AGA5R	▲	11
AB67	●	6	ACR2	●	17	AGA6	▲	11
AB68X	▲	7	ACR3	●	17	AGA7	●	11-225
AB69X	▲	7	ACR4	●	17	AGA8	▲	11
AB70X	▲	7	AD1	●	11	AGA9	●	11-225
AB71	▲	9	AD2	▲	11	AGA25	▲	11
AB72	▲	7	ADT1	▲	11	AGA25R	▲	11
AB72R	▲	7	AE1R	●▲	14	AGB1	●▲■U	11
AB74	●	10-225	AE2R	●▲	14	AGB1R	●▲UCS	11
AB75	●	6	AEP1	●▲	11	AGB2	●▲U	12
AB76	▲	9	AEP2	●▲	11	AGB2R	●▲U	12
AB76R	▲	9	AF4C	●▲	112	AGB3	●▲	12
AB77	●	10-225	AF4D	●▲	112	AGB3R	●▲U	12
AB78R	▲	6	AFA1	◆	270	AGB4	●▲	12
AB79RX	▲	7	AF11	◆	270	AGB4R	●▲	12
AB81	●	8	AG1	●▲	13	AGB5	●■CS	12-225
AB83	●▲	7	AG1R	▲	13	AGB6	●	12-226
AB84	●	10-225	AG2	●▲	13	AGB7	●	12-226
AB85	●	9	AG2R	●▲C	13	AGB8	●CS	12-225
AB86	▲	7	AG3	●▲G	13	AGB9	●S	12-225
AB88X	▲	7	AG3R	●▲	13	AGE1	●▲U	12
AB89	●▲	10	AG4	●▲	13	AGE1R	▲	12
AB90R	▲	9	AG4R	●▲	13	AGE2	▲	12
AB91	▲	10	AG5	▲	13	AGE3	▲	12
AB93R	▲	9	AG5R	▲	13	AGE4R	●▲	12
AB95	▲	10	AG6	●▲	13	AGE5R	▲	12
AB98	▲	10	AG6R	●▲	13	AGE6	▲	12
AB100	▲	10	AG7	●▲	13	AGN1	●	13-226
AB100R	▲	10	AG7R	●▲	13	AH1	▲	17
AB101RX	▲	7	AG8	▲	13	AHR2	●	13-226
AB102	▲	9	AG8R	▲	13	AI1	●U	15

● Brass
Ottone
Messing
Laiton
Latón
Latão

▲ Steel
Acciaio
Stahl
Acier
Acero
Aço

■ Nickel silver
Alpacca
Neusilber
Maillechort
Alpaca
Alpaca

◆ Iron
Ferro
Eisen
Fer
Hierro
Ferro

Ⓒ Available in Color
Disponibile in Color
Lieferbar in Color
Disponibile en Color
Disponibile en Color
Disponível em Color

Ⓘ Available in Ultralite
Disponibile in Ultralite
Lieferbar in Ultralite
Disponibile en Ultralite
Disponibile en Ultralite
Disponível em Ultralite

Ⓔ Available in Silky
Disponibile in Silky
Lieferbar in Silky
Disponibile en Silky
Disponibile en Silky
Disponível em Silky

REF.		PAGE	REF.		PAGE	REF.		PAGE
AI2	●	15	ALP16	●	16-226	ASAF1	◆	271
AIN1	◆	270	ALU1	●	16	ASEC1	● ▲	14
AKR1	● ▲ U	17	AMA1	◆	270	ASEC2	● ▲	15
AKR2	● ▲ U	17	AMC1R	●	16	ASI1	◆	271
AKR3	▲	17	AMC2R	●	16	ASI2	◆	271
AKR3R	▲	17	AMC3	●	17	ASN1	● ▲	20
AKR4	▲	18	AMG1R	●	17-226	ASS2	● ▲ U	22
AKR5	▲	18	AMG2R	●	17-226	ASS2R	● ▲	22
AKR6	▲	17	AMG3R	●	17-226	ASS3	●	23
AKR7	● ▲	17	AN1	▲	18	ASS3R	●	23
AKR8	● ▲	18	AN1R	● ▲	18	ASS4	●	24
AKR9R	▲	18	APA1R	▲	20	ASS4R	● ▲	24
AKR10	● ▲	18	APA2R	●	20	ASS6	● ▲ U	21-181
AKR11R	● ▲	18	APE1	◆	270	ASS6R	● ▲ U	21-181
AKR14	●	18	APE1F	◆	270	ASS7	● ▲	22
AKR15	●	18	APE2	◆	270	ASS8	● ▲	24
AKR16R	▲	18	APK1	▲	18	ASS8R	●	24
AL1	● ▲ U	13	APK2R	●	18-226	ASS9	● ▲	22
AL1R	▲	13	APK3R	●	18-226	ASS9R	● ▲	22
ALA1R	● ▲	15	APK4	●	18-226	ASS10	● ▲	22
ALA2R	▲	15	APK5R	●	18-226	ASS10R	● ▲	22
ALK1	●	15	AQ1	▲	19	ASS11	● ▲	22
ALK2	●	15	AQ1R	● ▲	19	ASS11R	● ▲	22
ALM1	▲	16	AQ2	▲	19	ASS12	● ▲	23
ALM1R	▲	16	AQ2R	▲	19	ASS13	▲	22
ALP1	● ▲	15	AQ3	▲	19	ASS13R	● ▲	22
ALP2	●	15	AQ3R	▲	19	ASS14	●	24
ALP3	▲	15	AQ4	▲	19	ASS15	● ▲	22
ALP4	● ▲	16	AQ4R	▲	19	ASS15R	● ▲	22
ALP4R	● ▲	16	ARE1	● ▲	19	ASS16	●	24
ALP5R	● ▲	16	ARF1	▲	19	ASS16R	●	24
ALP6R	● ▲	16	ARG1R	▲	19	ASS17	● ▲	22
ALP7R	▲	16	ARG2R	▲	19	ASS18R	●	24
ALP8R	● ▲	16	ARL1	● ▲	19	ASS19	● ▲	22
ALP9	● ▲	16	ARL1R	▲	19	ASS19R	● ▲	22
ALP9R	● ▲	16	ARO1	◆	270	ASS20	●	24
ALP10	● ▲	15	ARS1	▲	20	ASS20R	●	24
ALP11	▲	15	ARS2	▲	20	ASS21	● ▲	22
ALP12	●	16	ART1	● ▲	19	ASS21R	● ▲	22
ALP13R	●	16	ART1R	● ▲	19	ASS22	●	24
ALP14R	●	16	AS1	● ▲	20-54	ASS22R	●	24
ALP15R	●	16	ASAB1	◆	271	ASS23	● ▲	22

● Brass
Ottone
Messing
Laiton
Latón
Latão

▲ Steel
Acciaio
Stahl
Acier
Acero
Aço

■ Nickel silver
Alpacca
Neusilber
Maillechort
Alpaca
Alpaca

◆ Iron
Ferro
Eisen
Fer
Hierro
Ferro

Ⓒ Available in Color
Disponibile in Color
Lieferbar in Color
Disponibile en Color
Disponibile en Color
Disponível em Color

Ⓒ Available in Ultralite
Disponibile in Ultralite
Lieferbar in Ultralite
Disponibile en Ultralite
Disponibile en Ultralite
Disponível em Ultralite

Ⓒ Available in Silky
Disponibile in Silky
Lieferbar in Silky
Disponibile en Silky
Disponibile en Silky
Disponível em Silky

Articles and materials general index / Índice Generale articoli e materiali / Allgemeines Artikel- und Materialverzeichnis / Table des matières des articles et des matériaux / Índice general de los artículos y de los materiales / Índice geral dos artigos e dos materiais

REF.		PAGE	REF.		PAGE	REF.		PAGE
ASS23R	● ▲	22	ASS48R	● ▲	24	ASS82R	●	24
ASS24	●	24	ASS50	●	25	ASS84	● ▲	25
ASS24R	●	24	ASS50R	●	25	ASS84R	●	25
ASS25	● ▲	22	ASS51	●	25	ASS85	● ▲	25
ASS25R	● ▲	22	ASS51R	●	25	ASS85R	● ▲	25
ASS26	●	24	ASS52	● ■	25	ASS86	▲	25
ASS26R	●	24	ASS52R	● ▲ ■ U	25	ASS86R	● ▲	25
ASS27	● ▲	22	ASS53	●	23	ASS87	●	25
ASS27R	● ▲	22	ASS53R	●	23	ASS87R	● ▲	25
ASS28	●	24	ASS55	●	25	ASS88	●	25
ASS28R	● ▲	24	ASS55R	● ▲	25	ASS88R	●	25
ASS29	● ▲	22	ASS56	●	25	ASS90	▲	24
ASS29R	● ▲	22	ASS56R	●	25	ASS90R	● ▲	24
ASS30	●	24	ASS63	● ▲	21	ASS91	●	25
ASS30R	●	24	ASS63R	▲	21	ASS91R	●	25
ASS31	● ▲	22	ASS64	● ▲	22	ASS92	▲	25
ASS31R	● ▲	22	ASS64R	● ▲	22	ASS92R	● ▲	25
ASS32	● ▲	23	ASS65	● ▲	22	ASS93	●	25
ASS32R	● ▲	23	ASS65R	● ▲	22	ASS93R	●	25
ASS33	● ▲	22	ASS66	● ▲	22	ASS94	●	25
ASS33R	● ▲	22	ASS66R	●	22	ASS94R	●	25
ASS34	●	24	ASS67	● ▲	22	ASS102	●	25
ASS34R	● ▲	24	ASS67R	● ▲	22	ASS102R	●	25
ASS35	● ▲	22	ASS68R	● ▲	22	ASS103	● ▲	25
ASS35R	● ▲	22	ASS69	● ▲	22	ASS103R	●	25
ASS36	● ▲	24	ASS69R	● ▲	22	ASS104	●	25
ASS36R	● ▲	24	ASS73	●	23	ASS104R	●	25
ASS37	● ▲	22	ASS73R	● ▲	23	ASS105	▲	25
ASS37R	● ▲	22	ASS76	●	23	ASS105R	●	25
ASS38	● ▲	23	ASS76R	● ▲	23	ASS106R	● ▲	25
ASS38R	●	23	ASS77	●	23	ASS107	●	24
ASS39	● ▲	24	ASS77R	● ▲	23	ASS107R	●	24
ASS39R	● ▲	24	ASS78	●	23	ASS108	●	24
ASS40	●	23	ASS78R	● ▲	23	ASS109	●	24
ASS40R	●	23	ASS79	● ▲	23	ASS110	●	23
ASS42	●	23	ASS79R	● ▲	23	ASS110R	●	23
ASS42R	●	23	ASS7R	● ▲	22	ASS112	▲	23
ASS44	● ▲ U	22	ASS80	●	24	ASS112R	●	23
ASS44R	● ▲	22	ASS80R	●	24	ASS113	●	23
ASS45	● ▲	24	ASS81	●	24	ASS113R	●	23
ASS45R	●	24	ASS81R	● ▲	24	ASS115	▲	23
ASS47	● ▲	21	ASS82	● ▲	24	ASS115R	●	23

● Brass
Ottone
Messing
Laiton
Latón
Latão

▲ Steel
Acciaio
Stahl
Acier
Acero
Aço

■ Nickel silver
Alpacca
Neusilber
Maillechort
Alpaca
Alpaca

◆ Iron
Ferro
Eisen
Fer
Hierro
Ferro

Ⓒ Available in Color
Disponibile in Color
Lieferbar in Color
Disponibile en Color
Disponibile en Color
Disponível em Color

U Available in Ultralite
Disponibile in Ultralite
Lieferbar in Ultralite
Disponibile en Ultralite
Disponibile en Ultralite
Disponível em Ultralite

Ⓔ Available in Silky
Disponibile in Silky
Lieferbar in Silky
Disponibile en Silky
Disponibile en Silky
Disponível em Silky

REF.		PAGE	REF.		PAGE	REF.		PAGE
ASS116	▲	23	ASS140R	●	23	AUC4	●	19
ASS116R	▲	23	ASS141	●	23	AUC5	●	19
ASS118	▲	23	ASS142	●	23	AUC6	●	19
ASS118R	●	23	ASS143	●	21	AUD1	●▲	25
ASS119	▲	23	ASS144	●	21	AUN1	▲	26
ASS119R	●	23	ASS145	●	21	AUS1	●U	26
ASS120	●	22	ASS146	●	21	AV1	▲	26
ASS120R	●	22	ASS147	●	21	AV1R	▲	26
ASS121	●	22	ASS148	●	21	AV2	▲	26
ASS121R	●	22	ASS149	●	21	AVC1	▲	26
ASS123	●	25	ASS14R	●	24	AW1	▲	20
ASS123R	●	25	ASS150	●	21	AW2	▲	20
ASS124	●▲	22	ASS151	●	21	AW22	▲	20
ASS124R	●	22	ASS152	●	21	AW23	▲	20
ASS125	●	24	ASS153	●	21	AW3	●▲	20
ASS125R	●	24	ASS154	●	21	AW4	▲	20
ASS126	▲	23	ASS155	●▲	21	AW5	●▲■	20
ASS126R	●	23	ASS155R	●▲	21	AW6	●▲	20
ASS127	●▲	23	ASS172	●	21	AW7	●▲U	20
ASS127R	●	23	ASS174	●	21	AX2	▲	26
ASS128	●	23	ASS175R	●	21	AX12	●	26-227
ASS128R	●	23	ASS176	●	21	AY1	●▲■	4
ASS129	▲	25	ASS177	●	21	AY1P	●■	4
ASS129R	●	25	ASS178	●■	21	AY2	●■	5
ASS12R	●▲	23	ASS17R	●▲	22	AY2P	●	5
ASS130	▲	23	ASS18	●	24	AY3	●■	5
ASS130R	●	23	ASS180R	●	22	AY10P	●	6
ASS131	●	23	ASS181	●	21	AY11	●	4
ASS131R	●	23	ASS183	●	25	AY12	■	4
ASS132	●▲	25	ASS183R	●	25	AY13	■	5
ASS132R	●	25	ASS186	▲	21	AY14	■	5
ASS133	●	25	ASS187R	●	21	AY15	●	5
ASS133R	●	25	ASS188	▲	21	AY16	■	4
ASS134	●	23	AST1	◆	271	AY17	■	5
ASS134R	●	23	ASU1R	●▲U	13	AY18	■	5
ASS135	●	23	ASU2	▲	13	AY20	■	5
ASS136	●	23	AT1	●▲	25	AY21	■	5
ASS136R	●	23	AT1R	●▲	25	AY23	■	5
ASS137	●▲	21	AT2R	●▲	25	AY24	■	5
ASS138	●	23	ATA1	▲	25	AY25	■	5
ASS138R	●	23	ATA1R	▲	25	AY26	■	5
ASS139R	●	23	AUC1	●U	19	AY27	■	5

● Brass
Ottone
Messing
Laiton
Latón
Latão

▲ Steel
Acciaio
Stahl
Acier
Acero
Aço

■ Nickel silver
Alpaca
Neusilber
Maillechort
Alpaca
Alpaca

◆ Iron
Ferro
Eisen
Fer
Hierro
Ferro

Ⓒ Available in Color
Disponibile in Color
Lieferbar in Color
Disponibile en Color
Disponibile en Color
Disponível em Color

Ⓒ Available in Ultralite
Disponibile in Ultralite
Lieferbar in Ultralite
Disponibile en Ultralite
Disponibile en Ultralite
Disponível em Ultralite

Ⓒ Available in Silky
Disponibile in Silky
Lieferbar in Silky
Disponibile en Silky
Disponibile en Silky
Disponível em Silky

REF.		PAGE	REF.		PAGE	REF.		PAGE
AY28	■	6	BAB20	▲	29	BAB30R-9	▲	29
AY29	■	6	BAB21-3	▲	29	BAB31	▲	29
AY30	▲	4	BAB21-4	▲	29	BAB36R	▲	29
AY31	●	5	BAB21-5	▲	29	BAD1	▲	30
AY3P	●	5	BAB25	●▲	28	BAD1R	▲	30
AZ1	▲	26	BAB25R	▲	28	BAE1	●	30-227
AZ2	●▲U⊕	27	BAB26R-1	●	29	BAE2R	●	30-227
AZ2R	▲U	27	BAB26R-10	●	29	BAE3	●	30-227
AZ2X	▲	27	BAB26R-11	●	29	BAI1	▲■U	31
AZ3	●▲U	26	BAB26R-12	▲	29	BAI2	▲	30
AZ3R	●▲U	26	BAB26R-13	▲	29	BAI23	▲	31
AZ4	●▲	27	BAB26R-14	▲	29	BAI25	▲	31
AZ5	●▲	27	BAB26R-15	▲	29	BAI25R	▲	31
AZ6	●U	27-227	BAB26R-16	▲	29	BAI3	▲	30
AZ6R	●	27-227	BAB26R-17	▲	29	BAI4R	▲	30
AZ7	●	27-227	BAB26R-18	▲	29	BAI5R	▲	30
AZ8	●	27-227	BAB26R-19	▲	29	BAI7	▲	31
AZ9	▲	27	BAB26R-2	●	29	BAL1	▲	28
AZ9R	▲	27	BAB26R-20	▲	29	BAL1R	●▲	28
AZ10	▲⊕	27	BAB26R-21	▲	29	BAL2	▲	28
AZ10R	▲	27	BAB26R-22	▲	29	BAL3	▲	28
AZ11	▲	27	BAB26R-23	▲	29	BAL4	▲	28
AZ1R	●▲	26	BAB26R-3	●	29	BAL5	▲	28
B			BAB26R-4	●	29	BAL6	●	28
BA1	●▲	31	BAB26R-5	●	29	BAL7	●▲	28
BA5	●▲	31	BAB26R-6	●	29	BAR1	▲	30
BA5R	●▲	31	BAB26R-7	●	29	BAR1R	▲	30
BA8	●▲	31	BAB26R-8	●	29	BAS1	●▲	31
BA8R	●▲	31	BAB26R-9	●	29	BAS4R	▲	31
BAB2R	▲	28	BAB27	●	28	BAS5R	▲	31
BAB4R	▲	28	BAB28R	●	28	BAT1P	■	31
BAB5R	●▲	28	BAB29	●	28	BAT2	▲	32
BAB6R	●▲	28	BAB30R-1	▲	29	BC1	▲	30
BAB7R	▲	28	BAB30R-10	▲	29	BC1R	▲	30
BAB13	●▲⊕	28	BAB30R-11	▲	29	BD1	▲	39
BAB13R	●▲	28	BAB30R-2	▲	29	BD10	▲	39
BAB14	▲	28	BAB30R-3	▲	29	BD10R	▲	39
BAB15	▲	29	BAB30R-4	▲	29	BD11	●	39-228
BAB16	▲	29	BAB30R-5	▲	29	BD11X	●	39-228
BAB18R	▲	28	BAB30R-6	▲	29	BD13	●	39-228
BAB19	▲	29	BAB30R-7	▲	29	BD14	●	39-228
			BAB30R-8	▲	29	BD14X	●	39-228

● Brass
Ottone
Messing
Laiton
Latón
Latão

▲ Steel
Acciaio
Stahl
Acier
Acero
Aço

■ Nickel silver
Alpacca
Neusilber
Maillechort
Alpaca
Alpaca

◆ Iron
Ferro
Eisen
Fer
Hierro
Ferro

Ⓒ Available in Color
Disponibile in Color
Lieferbar in Color
Disponibile en Color
Disponibile en Color
Disponível em Color

Ⓘ Available in Ultralite
Disponibile in Ultralite
Lieferbar in Ultralite
Disponibile en Ultralite
Disponibile en Ultralite
Disponível em Ultralite

Ⓢ Available in Silky
Disponibile in Silky
Lieferbar in Silky
Disponibile en Silky
Disponibile en Silky
Disponível em Silky

REF.		PAGE	REF.		PAGE	REF.		PAGE
BD16	●	39-228	BES17	▲	33	BK18	▲	34
BD17	▲	39	BES18	● ■	33	BK1R	● ▲ U	34
BD2	▲	39	BEY1R	●	33-227	BK1X	● ▲ U S	34
BD21	●	39-228	BEY2R	●	33-227	BK20	● ■	34
BD22	●	39-228	BG1	● ▲	34	BK21R	▲	34
BD2R	● ▲	39	BHF1T	◆	36	BK22R	▲	34
BD3	● ▲ U	39	BI062	●	33	BK23R	▲	34
BD3R	● ▲ U	39	BI063	● ▲	33	BK26	▲	35
BD4	● ▲	39	BI110	●	33	BK27	▲	34
BD4R	● ▲	39	BIL1T	●	34	BK28	▲ ■	34
BD5	▲	39	BK1	● ▲ U C	34	BK29	● ■	34
BD6	● ▲ C	39	BK100	▲	34	BK2R	● ▲	34
BD6R	● ▲ C	39	BK10-00	■	36	BK30	■	34
BD7	▲	39	BK10-01	■	36	BK31	■	34
BD8	▲	39	BK10-02	■	36	BK3-1	● ▲	34
BD8R	▲	39	BK10-03	■	36	BK3-10	● ▲	34
BD9R	● ▲ U C S	39	BK10-04	■	36	BK3-11	● ▲	34
BD100	●	39	BK10-05	■	36	BK3-12	● ▲ C	34
BD101	●	39	BK10-06	■	36	BK32	■	34
BD102	●	39	BK10-07	■	36	BK3-2	● ▲	34
BDA10	▲	36	BK10-08	■	36	BK3-3	● ▲ C	34
BE1	● ▲	33	BK10-09	■	36	BK34	■	34
BE1R	●	33	BK10-10	■	36	BK3-4	● ▲ C	34
BE200	● ▲ U C	33	BK10-11	■	36	BK3-5	● ▲	34
BE201	● ▲ U C	33	BK10-12	■	36	BK36	■	34
BE202	● ▲ U C	33	BK10-13	■	36	BK3-6	● ▲	34
BE203	● ▲ U	33	BK10-14	■	36	BK37	■	34
BES2	● ▲ ■	33	BK10-15	■	36	BK3-7	● ▲ C	34
BES3	● ■	33	BK10-16	■	36	BK38	■	34
BES4	● ■	33	BK10-17	■	36	BK3-8	● ▲ C	34
BES5	● ■	33	BK10-18	■	36	BK3-9	● ▲	34
BES6	● ▲ ■	33	BK10-19	■	36	BK4	▲	35
BES7	● ■	33	BK10-20	■	36	BK48R	▲	34
BES8	● ■	33	BK10-21	■	36	BK49R	▲	34
BES9	● ■	33	BK10-22	■	36	BK4R	● ▲	35
BE3	● ▲ U	33	BK10-23	■	36	BK5-1	● ▲	35
BE4R	●	33	BK10-30	■	36	BK5-10	● ▲	35
BES1	● ▲ ■	33	BK11R	▲	35	BK5-11	● ▲	35
BES10	● ■	33	BK13	▲	34	BK5-12	● ▲	35
BES11	● ■	33	BK15	● ▲	34	BK5-13	● ▲	35
BES12	● ■	33	BK16	▲	34	BK5-14	● ▲	35
BES16	▲	33	BK17	▲	34	BK5-15	● ▲	35

● Brass
Ottone
Messing
Laiton
Latón
Latão

▲ Steel
Acciaio
Stahl
Acier
Acero
Aço

■ Nickel silver
Alpaca
Neusilber
Maillechort
Alpaca
Alpaca

◆ Iron
Ferro
Eisen
Fer
Hierro
Ferro

C Available in Color
Disponibile in Color
Lieferbar in Color
Disponibile en Color
Disponível em Color

U Available in Ultralite
Disponibile in Ultralite
Lieferbar in Ultralite
Disponibile en Ultralite
Disponível em Ultralite

S Available in Silky
Disponibile in Silky
Lieferbar in Silky
Disponibile en Silky
Disponível em Silky

REF.		PAGE	REF.		PAGE	REF.		PAGE
BK5-16	● ▲	35	BK6-19	● ▲	35	BLA2	▲	36
BK5-17	●	35	BK6-2	● ▲	35	BLA3	▲	36
BK5-18	● ▲	35	BK6-20	● ▲	35	BLG1	▲	41
BK5-19	● ▲	35	BK6-21	●	35	BLG2	▲	41
BK52	■	34	BK6-22	● ▲	35	BLL1	● ▲	32
BK5-2	● ▲	35	BK6-23	● ▲	35	BLL2	● ▲	32
BK5-20	● ▲	35	BK6-24	● ▲	35	BLL3	● ▲	32
BK5-21	● ▲	35	BK6-25	● ▲	35	BLL4	● ▲	32
BK5-22	● ▲	35	BK6-26	●	35	BLL5	● ▲	32
BK5-23	● ▲	35	BK6-27	● ▲	35	BLT1R	▲	179
BK5-24	● ▲	35	BK6-28	● ▲	35	BLV1R	●	32
BK5-25	● ▲	35	BK6-29	● ▲	35	BLV2R	●	32
BK5-26	● ▲	35	BK6-3	● ▲	35	BLV3	●	32
BK5-27	● ▲	35	BK6-30	● ▲	35	BM1	● ■	30
BK5-28	● ▲	35	BK6-31	● ▲	35	BM2	●	30
BK5-29	● ▲	35	BK6-32	● ▲	35	BMB1	● ▲	36
BK53	■	34	BK6-33	●	35	BMB1R	●	36
BK5-3	● ▲	35	BK6-34	●	35	BMB2	● ▲	36
BK5-30	● ▲	35	BK6-35	●	35	BMB3	● ▲	36
BK5-31	● ▲	35	BK6-4	● ▲	35	BMB3R	●	36
BK5-32	● ▲	35	BK6-5	● ▲	35	BMB4	● ▲	36
BK5-33	● ▲	35	BK6-6	● ▲	35	BMB4R	●	36
BK5-34	●	35	BK6-7	● ▲	35	BMB5	● ▲	36
BK5-35	● ▲	35	BK6-8	● ▲	35	BN1	●	32
BK5-4	● ▲	35	BK6-9	● ▲	35	BN1R	●	32
BK5-5	● ▲	35	BK7R-1	● ▲	34	BN2	●	32
BK5-6	● ▲	35	BK7R-10	●	34	BN2R	●	32
BK5-7	● ▲	35	BK7R-2	●	34	BNK1	●	36-227
BK5-8	● ▲	35	BK7R-3	● ▲	34	BNL1R	▲	30
BK5-9	● ▲	35	BK7R-4	●	34	BO2	● ▲	37
BK60	▲	34	BK7R-5	● ▲	34	BO2R	● ▲	37
BK61	●	34-227	BK7R-6	● ▲	34	BO6	▲	37
BK6-1	● ▲	35	BK7R-7	● ▲	34	BO6R	▲	37
BK6-10	●	35	BK7R-8	● ▲	34	BOR1	●	37
BK6-11	● ▲	35	BK7R-9	● ▲	34	BOR1R	●	37
BK6-12	● ▲	35	BK8	●	35	BOS1	▲	37
BK6-13	●	35	BK8R	●	35	BOS3	● ▲	37
BK6-14	● ▲	35	BK99-03	■	34	BR1	●	38
BK6-15	● ▲	35	BK99-08	■	34	BRA1R	●	37
BK6-16	● ▲	35	BL1	▲	36	BRA2R	● U	37
BK6-17	● ▲	35	BL1R	● ▲	36	BRA3R	●	37
BK6-18	●	35	BLA1	▲	36	BRA5	● U	38

● Brass
Ottone
Messing
Laiton
Latón
Latão

▲ Steel
Acciaio
Stahl
Acier
Acero
Aço

■ Nickel silver
Alpacca
Neusilber
Maillechort
Alpaca
Alpaca

◆ Iron
Ferro
Eisen
Fer
Hierro
Ferro

Ⓒ Available in Color
Disponibile in Color
Lieferbar in Color
Disponibile en Color
Disponibile en Color
Disponível em Color

U Available in Ultralite
Disponibile in Ultralite
Lieferbar in Ultralite
Disponibile en Ultralite
Disponibile en Ultralite
Disponível em Ultralite

Ⓔ Available in Silky
Disponibile in Silky
Lieferbar in Silky
Disponibile en Silky
Disponibile en Silky
Disponível em Silky

REF.		PAGE	REF.		PAGE	REF.		PAGE
BRA6R	● U	38	BUR6	▲	41-135	BUS1	● ▲	44
BRA7R	● U	37	BUR7	▲	41	BUT1R	■	41-228
BRA8R	● U	38	BUR8	● ▲	41	BUT2R	▲	41
BRA9R	●	37	BUR9	▲	42	BUT3R	▲	41
BRA10R	● U	37	BUR10R	▲	42	BUT4R	▲	41
BRA11R	● U	38	BUR11	● ▲	42	BVA1	● ▲ U	44
BRA15R	●	38	BUR12	▲	42	BVA1R	▲	44
BRA16R	●	37	BUR13	▲	43	BVA3	● ▲	44
BRM1	● ▲	40	BUR14R	▲	43	BVA4	▲	44
BRM1R	●	40	BUR15	▲	42	BY1	▲	37
BRS1R	●	40-228	BUR16	▲	42	BZ2	▲	154
BRS2	▲	40	BUR17R	▲	42	BZ2R	▲	154
BRS3R	●	40-228	BUR18	▲	43	BZ3	●	154-243
BRT1	● ▲	32	BUR19	▲	42	C		
BRT2	▲	33	BUR20	▲	43	C1	● ▲	63
BRT3	▲	33	BUR20R	▲	43	C1R	● ▲	63
BRT4	▲	33	BUR21	● ▲	43	C303	▲	54
BS1	● ▲	40	BUR21R	▲	43	C555	● ▲	54
BS2	▲ U	40	BUR22	▲	42	CA1	● ▲	58
BS3	● ▲	40	BUR22R	▲	42	CA2	● ▲ U	58-222
BS4R	▲	40	BUR23	● ▲	42	CA2R	● ▲ U	58-222
BS5	▲	40	BUR23R	▲	42	CA3	▲	58
BS5R	▲ U	40	BUR24R	▲	43	CA4	▲	58
BS6R	▲	40	BUR25	▲	42	CA5	▲	58
BS7	▲	40	BUR26	▲	43	CA6	▲	221
BS7R	▲	40	BUR27	●	44-228	CA7	● ▲	222
BSI1	● ▲	31	BUR28R	▲	43	CA8	● ▲ U	221
BSI1R	● ▲	31	BUR29	▲	42	CA9	● ▲	119
BSI2	● ▲	31	BUR31	▲	43	CA10	▲	222
BSI2R	● ▲	31	BUR31R	▲	43	CA10R	▲	222
BSI4	● ▲	31	BUR32	●	43	CA11	▲ U	222
BSI4R	● ▲	31	BUR33	●	44-228	CA11R	▲	222
BU1	● ▲	41	BUR34R	● ▲	43	CA12	▲	221
BU1R	● ▲	41	BUR35	▲	42	CA13	▲	221
BUR1	▲	41	BUR36	▲	42	CA14	▲	221
BUR1R	▲	41	BUR38	▲	43	CA15	▲ U	58-222
BUR2	▲ U	41-136	BUR55R	▲	44	CAB1	● ▲	44
BUR2R	▲	41-136	BUR56	▲	44	CAB2R	● ▲	44
BUR3	▲	42	BUR57R	▲	44	CAF1	● ▲	44
BUR3R	▲	42	BUR60R	▲	43	CAF1R	● ▲	44
BUR4	▲	42	BUR61R	▲	43	CAF2	● ▲	44
BUR5	▲	42	BUR62	▲	42			

● Brass
Ottone
Messing
Laiton
Latón
Latão

▲ Steel
Acciaio
Stahl
Acier
Acero
Aço

■ Nickel silver
Alpaca
Neusilber
Maillechort
Alpaca
Alpaca

◆ Iron
Ferro
Eisen
Fer
Hierro
Ferro

Ⓒ Available in Color
Disponibile in Color
Lieferbar in Color
Disponibile en Color
Disponibile en Color
Disponível em Color

Ⓒ Available in Ultralite
Disponibile in Ultralite
Lieferbar in Ultralite
Disponibile en Ultralite
Disponibile en Ultralite
Disponível em Ultralite

Ⓒ Available in Silky
Disponibile in Silky
Lieferbar in Silky
Disponibile en Silky
Disponibile en Silky
Disponível em Silky

REF.		PAGE	REF.		PAGE	REF.		PAGE
CAF2R	● ▲	44	CB24R	● ▲ ■ U	62	CB101R	▲	60
CAR1	● ▲	45	CB25R	● ▲	62	CB102R	●	62
CAX1R	● ▲	45	CB26R	●	62	CB103R	▲	60
CAX2R	● ▲	45	CB27R	●	62	CB104R	●	61
CB1	● ▲ U	59-146	CB28R	● ▲	61	CB105R	●	60
CB1R	▲	59-146	CB29	● ▲	61	CB106	▲	61
CB2	● ▲	59	CB29R	● ▲	61	CC1	● ▲ U C	63
CB2R	● ▲	59	CB30	● ▲ U	61	CC1R	● U	63
CB3	● ▲	59-146	CB30R	● ▲	61	CC2	● ▲ U	62
CB3-OR	U	59	CB31	▲ ■	61	CC2R	● ▲ U	62
CB3R	● ▲ U	59	CB32	● ▲	60	CC3	● U	62
CB4	● ▲	60	CB33R	● ▲	62	CC3R	● ▲ U	62
CB4-OR	U	60	CB34R	● ▲ U	62	CC4	●	62
CB4R	● ▲	60	CB37	●	61	CC5	●	62
CB5	● ▲ U	60	CB38	● ▲	61	CC6R	● U	62
CB5R	● ▲	60	CB38R	● ▲	61	CC7	●	62
CB6	● ▲ U C S	60-125	CB39R	▲	61	CC7R	● ▲	62
CB6-OR	U	60	CB40R	●	62	CC8	●	63
CB6R	▲ U	60	CB41R	● ▲	62	CCC1	●	46
CB7	● ▲ C	60	CB42	▲	60	CCC1R	●	46
CB7R	● ▲	60	CB43R	● ▲	60	CDP1R	▲	46
CB8	● ▲ C	60	CB44R	● U	62	CE1	● ▲ U C	47
CB9	● ▲ C	60	CB70	●	60	CE10	● ▲	47
CB9-OR	U	60	CB78R	● ▲	60	CE11	● ▲	47
CB10	● ▲ C	62	CB79	●	60	CE114	●	48
CB11	● ▲ C	61	CB80	● ▲	59	CE11R	▲	47
CB11R	● U	61	CB81	● ▲	60	CE12	● ▲	48
CB12	● ▲ C	61	CB82	●	61	CE13	▲	47
CB12R	● ▲	61	CB83	● ▲	61	CE13R	● ▲	47
CB13	● ▲ C	62	CB84	●	61	CE14-15	● ▲	49
CB13R	● ▲	62	CB85	● ▲ C	60	CE14-16	● ▲	49
CB14	● ▲ C	62	CB86	●	61	CE14-17	● ▲	49
CB14R	● ▲	62	CB87	●	61-230	CE14-18	● ▲	49
CB15	● ▲ C	60	CB88R	●	61	CE14-25	● ▲	49
CB16	▲ U C	60	CB89R	●	61	CE14-26	● ▲	49
CB17	▲ U C	60	CB90R	● ▲	61	CE14-27	● ▲	49
CB18	● ▲	61	CB95R	●	60	CE14-28	● ▲	49
CB19	▲	60	CB96R	● ▲	60	CE14-35	● ▲	49
CB20	● ▲	62	CB97	● C S	61-230	CE14-36	● ▲	49
CB21	● ▲ U	61	CB98	●	61-230	CE14-37	● ▲	49
CB22R	● ▲ U	62	CB99R	▲	60	CE14-38	●	49
CB23R	● ▲ ■ U	62	CB100R	▲	60	CE14-45	●	49

● Brass
Ottone
Messing
Laiton
Latón
Latão

▲ Steel
Acciaio
Stahl
Acier
Acero
Aço

■ Nickel silver
Alpacca
Neusilber
Maillechort
Alpaca
Alpaca

◆ Iron
Ferro
Eisen
Fer
Hierro
Ferro

C Available in Color
Disponibile in Color
Lieferbar in Color
Disponibile en Color
Disponibile en Color
Disponível em Color

U Available in Ultralite
Disponibile in Ultralite
Lieferbar in Ultralite
Disponibile en Ultralite
Disponibile en Ultralite
Disponível em Ultralite

S Available in Silky
Disponibile in Silky
Lieferbar in Silky
Disponibile en Silky
Disponibile en Silky
Disponível em Silky

REF.		PAGE	REF.		PAGE	REF.		PAGE
CE14-46	●	49	CE129-37	●	50	CE129-79	●	50
CE14-47	● ▲	49	CE129-38	●	50	CE129-80	●	50
CE14-48	● ▲	49	CE129-39	●	50	CE129-81	●	50
CE15	● ▲	49	CE129-40	●	50	CE129-82	●	50
CE16	●	49	CE129-41	●	50	CE129-83	●	50
CE127	● ▲	48	CE129-42	●	50	CE129-84	●	50
CE129-1	●	50	CE129-43	●	50	CE129-85	●	50
CE129-2	●	50	CE129-44	●	50	CE129-86	●	50
CE129-3	●	50	CE129-45	●	50	CE129-87	●	50
CE129-4	●	50	CE129-46	●	50	CE129-88	●	50
CE129-5	●	50	CE129-47	●	50	CE129-89	●	50
CE129-6	●	50	CE129-48	●	50	CE129-90	●	50
CE129-7	●	50	CE129-49	●	50	CE130-1	●	51
CE129-8	●	50	CE129-50	●	50	CE130-2	●	51
CE129-9	●	50	CE129-51	●	50	CE130-3	●	51
CE129-10	●	50	CE129-52	●	50	CE130-4	●	51
CE129-11	●	50	CE129-53	●	50	CE130-5	●	51
CE129-12	●	50	CE129-54	●	50	CE130-6	●	51
CE129-13	●	50	CE129-55	●	50	CE130-7	●	51
CE129-14	●	50	CE129-56	●	50	CE130-8	●	51
CE129-15	●	50	CE129-57	●	50	CE130-9	●	51
CE129-16	●	50	CE129-58	●	50	CE130-10	●	51
CE129-17	●	50	CE129-59	●	50	CE130-11	●	51
CE129-18	●	50	CE129-60	●	50	CE130-12	●	51
CE129-19	●	50	CE129-61	●	50	CE130-13	●	51
CE129-20	●	50	CE129-62	●	50	CE130-14	●	51
CE129-21	●	50	CE129-63	●	50	CE130-15	●	51
CE129-22	●	50	CE129-64	●	50	CE130-16	●	51
CE129-23	●	50	CE129-65	●	50	CE130-17	●	51
CE129-24	●	50	CE129-66	●	50	CE130-18	●	51
CE129-25	●	50	CE129-67	●	50	CE130-19	●	51
CE129-26	●	50	CE129-68	●	50	CE130-20	●	51
CE129-27	●	50	CE129-69	●	50	CE130-21	●	51
CE129-28	●	50	CE129-70	●	50	CE130-22	●	51
CE129-29	●	50	CE129-71	●	50	CE130-23	●	51
CE129-30	●	50	CE129-72	●	50	CE130-24	●	51
CE129-31	●	50	CE129-73	●	50	CE130-25	●	51
CE129-32	●	50	CE129-74	●	50	CE130-26	●	51
CE129-33	●	50	CE129-75	●	50	CE130-27	●	51
CE129-34	●	50	CE129-76	●	50	CE130-28	●	51
CE129-35	●	50	CE129-77	●	50	CE130-29	●	51
CE129-36	●	50	CE129-78	●	50	CE130-30	●	51

● Brass
Ottone
Messing
Laiton
Latón
Latão

▲ Steel
Acciaio
Stahl
Acier
Acero
Aço

■ Nickel silver
Alpaca
Neusilber
Maillechort
Alpaca
Alpaca

◆ Iron
Ferro
Eisen
Fer
Hierro
Ferro

Ⓒ Available in Color
Disponibile in Color
Lieferbar in Color
Disponibile en Color
Disponibile en Color
Disponível em Color

Ⓘ Available in Ultralite
Disponibile in Ultralite
Lieferbar in Ultralite
Disponibile en Ultralite
Disponibile en Ultralite
Disponível em Ultralite

Ⓔ Available in Silky
Disponibile in Silky
Lieferbar in Silky
Disponibile en Silky
Disponibile en Silky
Disponível em Silky

REF.		PAGE	REF.		PAGE	REF.		PAGE
CE130-31	●	51	CE17X31	● ▲ ■	49	CE28	● ▲	48
CE130-32	●	51	CE17X32	● ▲ ■	49	CE29R	● ▲	47
CE130-33	●	51	CE17X33	● ▲ ■	49	CE2R	● ▲	47
CE130-34	●	51	CE17X34	● ▲ ■	49	CE2X	● ▲ U G S	47
CE130-35	●	51	CE17X35	● ▲ ■	49	CE3	● ▲ U	47
CE131	●	49-228	CE17X36	● ▲ ■	49	CE30	● ▲	47
CE147	▲	47	CE17X37	● ▲ ■	49	CE30R	● ▲	47
CE149	▲	49	CE17X38	● ▲ ■	49	CE31	● ▲	48
CE150	●	48	CE17X39	● ▲ ■	49	CE32R	● ▲	48
CE153R	▲	47-48	CE17X40	● ▲ ■	49	CE33	● ▲	47
CE154	▲	48	CE17X41	● ▲ ■	49	CE34	▲	47
CE155	▲	48	CE17X42	● ▲ ■	49	CE35	▲	47
CE158	●	49	CE17XPS	● ▲	48	CE36	▲	47
CE17W23	● ▲ ■	49	CE18	▲	47	CE38W23	▲	50
CE17W24	● ▲ ■	49	CE18R	● ▲	47	CE38W24	▲	50
CE17W25	● ▲ ■	49	CE19	● ▲	47	CE38W25	▲	50
CE17W26	● ▲ ■	49	CE19R	● ▲	47	CE38W26	▲	50
CE17W27	● ▲ ■	49	CE1R	● ▲	47	CE38W27	▲	50
CE17W28	● ▲ ■	49	CE2	● ▲ U G	47	CE38W28	▲	50
CE17W29	● ▲ ■	49	CE20	● ▲ U S	48	CE38W29	▲	50
CE17W30	● ▲ ■	49	CE21R	● ▲	47	CE38W30	▲	50
CE17W31	● ▲ ■	49	CE22-15	●	49	CE38W31	▲	50
CE17W32	● ▲ ■	49	CE22-16	● ▲	49	CE38W32	▲	50
CE17W33	● ▲ ■	49	CE22-17	●	49	CE38W33	▲	50
CE17W34	● ▲ ■	49	CE22-18	●	49	CE38W34	▲	50
CE17W35	● ▲ ■	49	CE22-25	●	49	CE38W35	▲	50
CE17W36	● ▲ ■	49	CE22-26	●	49	CE38W36	▲	50
CE17W37	● ▲ ■	49	CE22-27	●	49	CE38W37	▲	50
CE17W38	● ▲ ■	49	CE22-28	● ▲	49	CE38W38	▲	50
CE17W39	● ▲ ■	49	CE22-35	●	49	CE38W39	▲	50
CE17W40	● ▲ ■	49	CE22-36	●	49	CE38W40	▲	50
CE17W41	● ▲ ■	49	CE22-37	●	49	CE38W41	▲	50
CE17W42	● ▲ ■	49	CE22-38	●	49	CE38W42	▲	50
CE17WPS	● ▲	48	CE22-45	● ▲	49	CE39	● ▲	49
CE17X23	● ▲ ■	49	CE22-46	●	49	CE3R	● ▲	47
CE17X24	● ▲ ■	49	CE22-47	●	49	CE4	● ▲	47
CE17X25	● ▲ ■	49	CE22-48	●	49	CE40	▲	48
CE17X26	● ▲ ■	49	CE23R	● ▲	48	CE41	● ▲ U	48
CE17X27	● ▲ ■	49	CE24R	● ▲	48	CE41XL	▲	48
CE17X28	● ▲ ■	49	CE25R	● ▲	48	CE41X-OV	▲	48
CE17X29	● ▲ ■	49	CE26R	● ▲	48	CE4R	● ▲	47
CE17X30	● ▲ ■	49	CE27	● ▲	48	CE5	● ▲	47

● Brass
Ottone
Messing
Laiton
Latón
Latão

▲ Steel
Acciaio
Stahl
Acier
Acero
Aço

■ Nickel silver
Alpacca
Neusilber
Maillechort
Alpaca
Alpaca

◆ Iron
Ferro
Eisen
Fer
Hierro
Ferro

Ⓒ Available in Color
Disponibile in Color
Lieferbar in Color
Disponibile en Color
Disponibile en Color
Disponível em Color

Ⓘ Available in Ultralite
Disponibile in Ultralite
Lieferbar in Ultralite
Disponibile en Ultralite
Disponibile en Ultralite
Disponível em Ultralite

Ⓔ Available in Silky
Disponibile in Silky
Lieferbar in Silky
Disponibile en Silky
Disponibile en Silky
Disponível em Silky

REF.		PAGE	REF.		PAGE	REF.		PAGE
CE6	● ▲	47	CHS1	● ▲	52	CLU1	●	59
CE6R	▲	47	CHU5	● ▲ ■	52	CLU1R	●	59
CE7	● ▲	47	CHU6	▲	52	CLU2	●	59
CE7R	● ▲	47	CHU7	■	26	CLU2R	●	59
CE8	● ▲	47	CHV1	▲	51	CLU3	●	59
CE9	● ▲	47	CHV1R	● ▲	51	CLU3R	●	59
CEE1	▲	46	CIA1	● U	52	CLU4	●	59
CEN1	● ▲ U	46	CIL1	● ▲	53	CLU4R	●	59
CEN1R	● ▲ U G	46	CIL1R	●	53	CLU5	●	59
CEN2	▲	46	CIL2	● U	53	CLU5R	●	59
CEN2R	▲	46	CIL2R	● ▲	53	CM1	● ▲	46
CEN3	▲	46	CIL3	●	53	CM1R	● ▲	46
CEN4R	● ▲	46	CIL4	● ▲	53	CM2	● ▲	46-95
CEN5T	●	46	CIL5	●	53	CM2R	● ▲	46-95
CF1	▲	53	CIL6	● ▲ U	53	CM3	● ▲	46
CF1R	● ▲	53	CIL7	●	53	CM3R	● ▲	46
CF2	● ▲	53	CIS1	● ▲	45	CM4	● ▲	46
CF2R	● ▲	53	CIS11	● ▲	45	CM4R	● ▲	46
CF3	▲	53	CIS12	●	45-228	CNP1R	●	59
CF4	▲	53	CIS12X	●	45-228	CO1	● ▲	63
CH1	● ▲	51	CIS2	● ▲ U	45	CO1R	● ▲	63
CH10	●	52	CIS3	● ▲	45	COL1	● ▲	59
CH11	● ▲	52	CIS4	● ▲	45	COL2	● ▲	59
CH12	● ▲	52	CIS4R	●	45	COL3	● ▲	59
CH13	● ▲	52	CIS5	● ▲ U	45	COL4	● ▲	59
CH14	● ▲	52	CIS5R	●	45	COR1	● ▲	63
CH15	● ▲	51	CIS6	▲	45	COR2	●	63
CH16T	●	52	CIS6R	●	45	COR2R	●	63
CH17T	●	52	CIS7	●	45	CR2R	▲	59
CH18	● ▲	52	CIS8	●	45	CR5R	▲	59
CH19	● ▲	52	CIS9	●	45-228	CRE401	◆	270
CH2	● ▲	51	CK1	● ▲	51	CRE402	◆	270
CH24R	●	52	CKM1	● ▲	171	CRE403	◆	270
CH27	●	52	CLF2	▲	45	CRE404	◆	270
CH3	● ▲	51	CLI1	●	53	CRE405	◆	270
CH4	● ▲	51	CLK1	▲	51	CRE406	◆	270
CH5	● ▲	51	CLL1	● ▲	59	CRL1	●	53-228
CH6	●	51	CLS1	● ▲	53	CS10	● ▲	57
CH7	●	51	CLS2	● ▲	53	CS1003	◆	269
CH7R	● ▲	51	CLS220	●	53	CS105	●	55
CH8	● ▲	51	CLS242	● ▲	53	CS10R	● ▲	57
CH9T	●	52	CLS3	● ▲	53	CS11	● ▲	57

● Brass
Ottone
Messing
Laiton
Latón
Latão

▲ Steel
Acciaio
Stahl
Acier
Acero
Aço

■ Nickel silver
Alpaca
Neusilber
Maillechort
Alpaca
Alpaca

◆ Iron
Ferro
Eisen
Fer
Hierro
Ferro

Ⓒ Available in Color
Disponibile in Color
Lieferbar in Color
Disponibile en Color
Disponibile en Color
Disponível em Color

Ⓔ Available in Ultralite
Disponibile in Ultralite
Lieferbar in Ultralite
Disponibile en Ultralite
Disponibile en Ultralite
Disponível em Ultralite

Ⓕ Available in Silky
Disponibile in Silky
Lieferbar in Silky
Disponibile en Silky
Disponibile en Silky
Disponível em Silky

Articles and materials general index / Índice General de artículos e materiais / Allgemeines Artikel- und Materialverzeichnis / Table des matières des articles et des matériaux / Índice general de los artículos y de los materiales / Índice geral dos artigos e dos materiais

REF.		PAGE	REF.		PAGE	REF.		PAGE
CS115	● C	56-229	CS170	●	56	CS38R	● ▲	55
CS116AP	●	57-230	CS17R	● ▲	55	CS4	● ▲	56
CS116P	●	56-230	CS18	● ▲	55	CS41	●	55
CS119	● ▲ U S	56	CS18R	● ▲	55	CS42	●	55
CS119R	● ▲	56	CS19	▲	58	CS43	●	55
CS12	● ▲	14-57	CS19R	● ▲	58	CS44	● ▲	55
CS120	● ▲	56	CS20	● ▲	58	CS44R	●	55
CS120R	●	56	CS204	● ▲ U C S	55	CS45	● ▲	58
CS121	●	56	CS205	● ▲ U	55	CS45R	● ▲	58
CS12R	●	14-57	CS206	● ▲ U C S	55	CS46	● ▲	55
CS13	● ▲	55	CS207	● ▲ U	55	CS46R	● ▲	55
CS138	●	55	CS20R	● ▲	58	CS47	●	55
CS139	●	56-229	CS21	● ▲	57	CS47R	●	55
CS139AP	●	57-230	CS21R	●	57	CS48	● ▲ U	56-229
CS139P	●	56-230	CS22	●	57	CS49	● ▲	55
CS13R	▲	55	CS22R	●	57	CS4R	●	56
CS13X	▲	56	CS23	● ▲	40-58	CS5	● ▲	57
CS14	▲	55	CS23R	● ▲	40-58	CS50	● ▲	55
CS140	●	56-229	CS24	● ▲	55	CS500	● ▲	55
CS141	●	56-229	CS24R	●	55	CS500R	●	55
CS142	●	55	CS25	●	55	CS501	● ▲ U	55
CS143	●	55	CS25R	●	55	CS501R	● ▲ U	55
CS144	●	56-229	CS26	● ▲	40-58	CS52X	●	56
CS145	●	56-229	CS26R	▲	40-58	CS5R	●	57
CS146	● C	56-229	CS27	● ▲	58	CS6	● ▲ U	57
CS147	▲	55	CS27R	● ▲	58	CS61	● ▲	56
CS14R	●	55	CS28	● ▲	58-215	CS62	● C S	56-229
CS15	● ▲	55	CS28R	● ▲	58-215	CS62AP	●	57-230
CS152	● ▲	56	CS30	▲	55	CS62P	●	56-230
CS154AP	●	57-230	CS30R	●	55	CS66	●	56
CS155AP	●	57-230	CS31	●	55	CS67	●	55
CS156AP	●	57-230	CS31R	● ▲ U	55	CS68	●	55
CS157AP	●	57-230	CS32	● ▲	40-58	CS6R	● ▲	57
CS158AP	●	57-230	CS32R	● ▲	40-58	CS7	● ▲ U C S	57
CS159AP	●	57-230	CS33	● ▲	40-58	CS70	● S	56-229
CS15R	▲	55	CS33R	▲	40-58	CS70AP	●	57-230
CS16	● ▲	55	CS34	● ▲	55	CS70P	●	56-230
CS162	▲	55	CS34R	● ▲	55	CS7R	● ▲ U	57
CS163X	●	56	CS36	● ▲	55	CS8	● ▲	57
CS168	●	56	CS37	● ▲	55	CS85	● ▲	55
CS16R	● ▲	55	CS37R	● ▲	55	CS88	● ▲	55
CS17	● ▲ U	55	CS38	● ▲	55	CS8R	● ▲	57

● Brass
Ottone
Messing
Laiton
Latón
Latão

▲ Steel
Acciaio
Stahl
Acier
Acero
Aço

■ Nickel silver
Alpacca
Neusilber
Maillechort
Alpaca
Alpaca

◆ Iron
Ferro
Eisen
Fer
Hierro
Ferro

C Available in Color
Disponibile in Color
Lieferbar in Color
Disponibile en Color
Disponibile en Color
Disponível em Color

U Available in Ultralite
Disponibile in Ultralite
Lieferbar in Ultralite
Disponibile en Ultralite
Disponibile en Ultralite
Disponível em Ultralite

S Available in Silky
Disponibile in Silky
Lieferbar in Silky
Disponibile en Silky
Disponibile en Silky
Disponível em Silky

REF.		PAGE	REF.		PAGE	REF.		PAGE
CS9	●	57	DB10R	▲	68	DB3	▲	68
CS9R	●▲	57	DB11	●▲	68	DB30	▲	68
CT1	●▲U	63	DB11R	●▲	68	DB30R	▲	68
CT1R	●	63	DB12	▲	68	DB31	▲	68
CT2	●▲	63	DB12R	▲	68	DB31R	▲	68
CT2R	●▲	63	DB13	●▲	68	DB32	●▲	68
CU401	◆	269	DB13R	●▲	68	DB32R	●▲	68
CU402	◆	269	DB14	●▲	68	DB33	●▲	68
CU403	◆	269	DB14R	●▲	68	DB33R	▲	68
CU404	◆	269	DB15	●▲	68	DB34	●▲	68
CU405	◆	269	DB15R	▲	68	DB34R	▲	68
CU406	◆	269	DB16	▲	68	DB35	▲	68
CU407	◆	269	DB16R	▲	68	DB35R	●▲	68
CU408	◆	269	DB17	●▲	68	DB36	▲	68
CU409	◆	269	DB17R	●▲	68	DB36R	▲	68
CU410	◆	269	DB18	●▲	68	DB37	▲	68
CU411	◆	269	DB18R	●▲	68	DB37R	▲	68
CU412	◆	270	DB19	▲	68	DB38	▲	68
CU413	◆	270	DB19R	▲	68	DB38R	▲	68
CV1	●	45	DB1R	▲	68	DB39	▲	68
CV2	●▲	45	DB2	▲	68	DB39R	▲	68
CV3	●▲	45	DB20	●▲	68	DB3R	●▲	68
CVL1	▲U	63	DB20R	▲	68	DB4	▲	68
CVL1R	▲U	63	DB21	▲	68	DB40	▲	68
CVL2	●▲U	63	DB21R	●▲	68	DB40R	▲	68
CVL2R	▲U	63	DB22	▲	68	DB41	▲	68
CVL3	●▲US	63	DB22R	▲	68	DB41R	●▲	68
CVL3R	●▲US	63	DB23	▲	68	DB42	▲	68
CVL4	▲	63	DB23R	▲	68	DB42R	▲	68
CVL5R	●	63-230	DB24	●▲	68	DB43	▲	68
CW1	●▲	63	DB24R	●▲	68	DB43R	▲	68
CX7	◆	269	DB25	▲	68	DB44	▲	68
CYS1	▲US	46	DB25R	▲	68	DB44R	▲	68
CYS1R	▲	46	DB26	●▲	68	DB45	▲	68
CYS2	●	46-228	DB26R	●▲	68	DB45R	●▲	68
D			DB27	●▲	68	DB46	▲	68
DAL1	●	64	DB27R	▲	68	DB46R	▲	68
DAL2	●▲	64	DB28	▲	68	DB47	●▲	68
DAL2R	●▲	64	DB28R	▲	68	DB47R	●▲	68
DB1	▲	68	DB29	▲	68	DB48	▲	68
DB10	●▲	68	DB29R	▲	68	DB48R	●▲	68
			DB2R	▲	68	DB49	●▲	68

● Brass
Ottone
Messing
Laiton
Latón
Latão

▲ Steel
Acciaio
Stahl
Acier
Acero
Aço

■ Nickel silver
Alpaca
Neusilber
Maillechort
Alpaca
Alpaca

◆ Iron
Ferro
Eisen
Fer
Hierro
Ferro

Ⓒ Available in Color
Disponibile in Color
Lieferbar in Color
Disponibile en Color
Disponibile en Color
Disponível em Color

Ⓒ Available in Ultralite
Disponibile in Ultralite
Lieferbar in Ultralite
Disponibile en Ultralite
Disponibile en Ultralite
Disponível em Ultralite

Ⓒ Available in Silky
Disponibile in Silky
Lieferbar in Silky
Disponibile en Silky
Disponibile en Silky
Disponível em Silky

REF.		PAGE	REF.		PAGE	REF.		PAGE
DB49R	▲	68	DD8	●	64	DM114	●▲	70
DB4R	●▲	68	DEA2	▲	64	DM115	▲	72
DB5	▲	68	DF3	▲	64	DM115R	●	72
DB50	▲	68	DF3R	▲	64	DM116	▲	70
DB50R	▲	68	DF4R	●	64-230	DM118	●	71-231
DB51	●▲	68	DFE1RP	■	65-231	DM119	●▲U S	70
DB51R	▲	68	DFE2P	●	65-231	DM120	●■	71-231
DB53	▲	68	DFE3RAP	●	65-231	DM12-00	●	72
DB53R	▲	68	DIR1R	●	65-231	DM12-1	●▲	72
DB54	▲	68	DK1	●	65-231	DM12-10	●▲	72
DB54R	▲	68	DK3	●	65-231	DM12-11	●▲	72
DB55	▲	68	DK4	●▲	65	DM12-12	●▲	72
DB55R	▲	68	DK5	●▲	65	DM12-13	●▲	72
DB56	●▲	68	DK6	●■	65-231	DM12-14	●▲	72
DB56R	●▲	68	DK6X	●	65-231	DM12-15	●	72
DB57	●▲	68	DK7	●	65-231	DM12-16	●	72
DB57R	●▲	68	DK8R	▲	65	DM12-17	●	72
DB58	▲	68	DK9R	▲	65	DM12-18	●	72
DB58R	▲	68	DL1R	▲	67-121	DM12-19	●▲	72
DB59	▲	68	DL2	●▲	67-121	DM122	■	71-231
DB59R	▲	68	DL3	●▲	67-121	DM12-2	●▲	72
DB5R	▲	68	DLC1	●	65-231	DM12-20	●	72
DB6	●▲C	68	DLC1R	●	65-231	DM12-21	●▲	72
DB60	▲	67	DLC2R	●	65-231	DM12-22	●▲	72
DB6R	▲C	68	DLC3	●	65-231	DM12-23	●	72
DB7	●▲	68	DM10	▲U	68	DM12-24	●	72
DB7R	●▲	68	DM101	●▲	69	DM12-25	●▲	72
DB8	●▲	68	DM102	▲	69	DM12-26	●	72
DB8R	●▲	68	DM103	●▲	70	DM12-27	●	72
DB9	●▲	68	DM104R	●▲	69	DM12-28	●	72
DB9R	▲	68	DM105R	●▲	70	DM12-29	●▲	72
DBX1R	●	67	DM106	●▲	69	DM12-3	●▲	72
DC1	●	64	DM108	●▲	73	DM12-30	●	72
DCR1	●▲U	75	DM108R	●	73	DM123-1	●	69
DCR2	▲U	75	DM109	●	73	DM12-31	●	72
DD1	▲	64	DM109R	▲	73	DM123-10	●	69
DD2	▲	64	DM10R	●▲	68	DM123-2	●	69
DD3	▲	64	DM11	●▲	69	DM12-32	●	72
DD4	▲	64	DM110	●▲	69	DM123-3	●	69
DD5	▲	64	DM111	●▲	69	DM12-33	●	72
DD6	▲	64	DM112	●▲	69	DM123-4	●	69
DD7	▲	64	DM113	●▲	69	DM12-34	●	72

● Brass
Ottone
Messing
Laiton
Latón
Latão

▲ Steel
Acciaio
Stahl
Acier
Acero
Aço

■ Nickel silver
Alpacca
Neusilber
Maillechort
Alpaca
Alpaca

◆ Iron
Ferro
Eisen
Fer
Hierro
Ferro

C Available in Color
Disponibile in Color
Lieferbar in Color
Disponibile en Color
Disponibile en Color
Disponível em Color

U Available in Ultralite
Disponibile in Ultralite
Lieferbar in Ultralite
Disponibile en Ultralite
Disponibile en Ultralite
Disponível em Ultralite

S Available in Silky
Disponibile in Silky
Lieferbar in Silky
Disponibile en Silky
Disponibile en Silky
Disponível em Silky

REF.		PAGE	REF.		PAGE	REF.		PAGE
DM123-5	●	69	DM14	●▲U	70	DM26R	●▲	72
DM12-35	●▲	72	DM141R	●	70	DM27	▲	71
DM123-6	●	69	DM144	■	71-231	DM28	●▲	69
DM12-36	●	72	DM145	■	71-231	DM29	●	72
DM123-7	●	69	DM149	▲	69	DM29R	●▲	72
DM12-37	●▲	72	DM150	▲	70	DM2R	▲	69
DM123-8	●	69	DM151R	●▲	70	DM3	●▲UC	70
DM12-38	●	72	DM152	▲	70	DM32	▲	70
DM123-9	●	69	DM153	▲	69	DM33R	●▲	72
DM12-39	●▲	72	DM154	▲	70	DM34	▲	69
DM12-4	●▲	72	DM154R	▲	70	DM34R	●▲	69
DM12-40	●	72	DM155	▲	70	DM35R	▲	70
DM12-41	●	72	DM16	●▲U	69	DM36	●▲	69
DM12-42	●	72	DM16R	●▲	69	DM36R	●▲	69
DM12-43	●	72	DM17	●▲	71	DM37	▲	69
DM12-44	●	72	DM17R	●▲	71	DM37R	●▲	69
DM12-45	●▲	72	DM18	●▲	72	DM38	●▲	69
DM12-46	●	72	DM18R	●▲	72	DM39	●▲	68
DM12-47	●	72	DM19	▲	69	DM39R	▲	68
DM12-5	●▲	72	DM19R	●▲	69	DM3X	▲UC	70
DM12-6	●▲	72	DM2	▲	69	DM4	●▲	68
DM12-7	●▲	72	DM20	●▲	70	DM40	●	72
DM128	●■	71-231	DM21	■	71-232	DM40R	●▲	72
DM12-8	●▲	72	DM22	■	70-232	DM41	●▲	69
DM12-9	●▲	72	DM22TV1	■	70-232	DM41R	●▲	69
DM12R-00	●▲	72	DM22TV10	■	70-232	DM42	●▲	72
DM12R-12	●▲	72	DM22TV2	■	70-232	DM42R	●▲	72
DM12R-13	●▲	72	DM22TV3	■	70-232	DM43	●	72
DM12R-16	●▲	72	DM22TV4	■	70-232	DM43R	●▲	72
DM12R-19	●▲	72	DM22TV5	●■	70-232	DM44	●▲	72
DM12R-31	●▲	72	DM22TV5X	●	71-232	DM44R	●▲	72
DM12R-32	●▲	72	DM22TV6	■	70-232	DM45	●■	72
DM12R-34	●▲	72	DM22TV7	■	70-232	DM45R	●▲	72
DM12R-35	●▲	72	DM22TV8	■	70-232	DM46	●▲	72
DM12R-36	●▲	72	DM22TV9	■	70-232	DM46R	●	72
DM13	▲	69	DM22TVP	●■	70-232	DM47	●▲	72
DM132	▲	70	DM22TVPX	●	71-232	DM47R	●▲	72
DM132R	▲	70	DM23	▲	69	DM48	▲	70
DM137	▲	69	DM23R	●▲	69	DM49	■	71-231
DM138	●	71-231	DM24	●■	71-232	DM4R	●▲	68
DM139	■	71-231	DM25	▲	70	DM5	▲	69
DM13R	▲	69	DM26	●▲	72	DM50	●	72

● Brass
Ottone
Messing
Laiton
Latón
Latão

▲ Steel
Acciaio
Stahl
Acier
Acero
Aço

■ Nickel silver
Alpaca
Neusilber
Maillechort
Alpaca
Alpaca

◆ Iron
Ferro
Eisen
Fer
Hierro
Ferro

Ⓒ Available in Color
Disponibile in Color
Lieferbar in Color
Disponibile en Color
Disponibile en Color
Disponível em Color

Ⓔ Available in Ultralite
Disponibile in Ultralite
Lieferbar in Ultralite
Disponibile en Ultralite
Disponibile en Ultralite
Disponível em Ultralite

Ⓕ Available in Silky
Disponibile in Silky
Lieferbar in Silky
Disponibile en Silky
Disponibile en Silky
Disponível em Silky

REF.		PAGE	REF.		PAGE	REF.		PAGE
DM50R	▲	72	DM65-32	● ▲	73	DM72	● ▲	72
DM52	● ▲	69	DM65-33	● ▲	73	DM72R	● ▲	72
DM53	■	71-231	DM65-34	●	73	DM73	● ▲	72
DM55	● ▲	71-231	DM65-35	● ▲	73	DM73R	● ▲	72
DM57	●	69	DM65-36	● ▲	73	DM74	●	72
DM58	● ▲	71-232	DM65-4	● ▲	73	DM74R	● ▲	72
DM5R	▲	69	DM65-40	●	73	DM75	● ▲	72
DM6	● ▲	68	DM65-41	●	73	DM75R	● ▲	72
DM60	● ▲	72	DM65-42	●	73	DM76	● ▲	73
DM60R	●	72	DM65-43	●	73	DM76R	● ▲	73
DM61	● ▲	68	DM65-44	●	73	DM77	● ▲	73
DM61R	● ▲	68	DM65-45	●	73	DM77R	● ▲	73
DM62	● ▲	69	DM65-46	●	73	DM78	● ▲	73
DM62R	● ▲	69	DM65-5	●	73	DM78R	● ▲	73
DM63	● ▲ ■	69	DM65-6	● ▲	73	DM79	● ▲	73
DM63R	● ▲	69	DM65-7	●	73	DM79R	● ▲	73
DM64	■	71-232	DM65-8	● ▲ ■	73	DM8	● ▲ U	68
DM65-00	●	73	DM65-9	●	73	DM80	● ▲	73
DM65-1	● ▲	73	DM65R-00	●	73	DM80R	● ▲	73
DM65-10	● ■	73	DM65R-12	●	73	DM81	● ▲	73
DM65-11	●	73	DM65R-13	●	73	DM81R	● ▲	73
DM65-12	●	73	DM65R-16	●	73	DM82	● ▲	73
DM65-13	● ▲	73	DM65R-19	●	73	DM82R	● ▲	73
DM65-14	●	73	DM65R-31	●	73	DM83	●	73
DM65-16	● ■	73	DM65R-32	● ▲ ■	73	DM83R	● ▲	73
DM65-17	●	73	DM65R-34	●	73	DM84	● ▲	73
DM65-18	● ▲	73	DM65R-35	●	73	DM84R	● ▲	73
DM65-19	●	73	DM65R-36	●	73	DM85	● ▲	73
DM65-2	● ■	73	DM66	●	72	DM85R	● ▲	73
DM65-20	●	73	DM66R	● ▲	72	DM86	● ▲	73
DM65-21	● ▲	73	DM67	●	72	DM86R	● ▲	73
DM65-22	● ▲	73	DM67R	● ▲	72	DM87	● ▲	73
DM65-23	● ▲	73	DM68	● ▲	72	DM87R	● ▲	73
DM65-24	●	73	DM68R	● ▲	72	DM88	● ▲	73
DM65-25	●	73	DM69	●	72	DM88R	● ▲	73
DM65-26	●	73	DM69R	● ▲	72	DM89	● ▲	73
DM65-27	● ▲	73	DM6R	▲	68	DM89R	● ▲	73
DM65-28	● ▲	73	DM7	● ▲	70	DM8R	▲	68
DM65-29	● ▲	73	DM70	●	72	DM90	● ▲	73
DM65-3	●	73	DM70R	● ▲	72	DM90R	● ▲	73
DM65-30	● ▲	73	DM71	● ▲	72	DM91	● ▲	73
DM65-31	● ▲	73	DM71R	● ▲	72	DM91R	● ▲	73

● Brass
Ottone
Messing
Laiton
Latón
Latão

▲ Steel
Acciaio
Stahl
Acier
Acero
Aço

■ Nickel silver
Alpacca
Neusilber
Maillechort
Alpaca
Alpaca

◆ Iron
Ferro
Eisen
Fer
Hierro
Ferro

Ⓒ Available in Color
Disponibile in Color
Lieferbar in Color
Disponibile en Color
Disponibile en Color
Disponível em Color

Ⓘ Available in Ultralite
Disponibile in Ultralite
Lieferbar in Ultralite
Disponibile en Ultralite
Disponibile en Ultralite
Disponível em Ultralite

Ⓔ Available in Silky
Disponibile in Silky
Lieferbar in Silky
Disponibile en Silky
Disponibile en Silky
Disponível em Silky

REF.		PAGE	REF.		PAGE	REF.		PAGE
DM92	● ▲	73	DX1	● ▲ U	66	ECM1R	▲	75
DM92R	● ▲	73	DX10R	● ▲	66	ED1	● ▲ U	80
DM93	● ▲	73	DX11R	● ▲	66	ED2	● ▲	80
DM93R	● ▲	73	DX12R	● ▲	66	ED3R	● ▲	80
DM94R	● ▲	73	DX13R	● ▲	66	ED4	● ▲	80
DM95	●	73	DX14R	● ▲	66	EF1R	● ▲	76
DM95R	●	73	DX15R	● ▲	66	EF2R	● ▲	76
DM96	● ▲	69	DX16R	● ▲	66	EF3R	● ▲	76
DM97R	● ▲	70	DX17R	▲	66	EF4R	● ▲	76
DM98R	● ▲	70	DX18R	▲	66	EF5R	● ▲	76
DMT1R	▲	67	DX19R	● ▲	66	EF6R	● ▲	76
DMT2R	▲	67	DX1R	● ▲ U	66	EF7	● ▲	76
DN1	● ▲	66	DX20R	● ▲	66	EG1	● ▲	75
DN2	● ▲ U	66	DX21R	● ▲	66	EG2	●	75
DN3	▲	66	DX22R	● ▲	66	EG2R	●	75
DN4	● ▲	66	DX23R	● ▲	66	EGR1	■	76
DN5	●	67	DX24R	● ▲	66	EK1	● ▲	78
DN6	● ▲	67	DX25R	● ▲	66	EK1R	● ▲	78
DN7	●	67	DX26R	● ▲	66	EK2	● ▲	78
DN8	● ▲	67	DX27R	● ▲	66	EK2R	● ▲	78
DN9R	▲	66	DX28R	● ▲	66	EK3	● ▲	78
DO10	▲	74	DX2R	▲	66	EK3R	●	78
DO11	● ▲	74	DX3	● ▲ U	66	EK4	● ▲	78
DO12	▲	74	DX3R	● ▲ U	66	EK4R	● ▲	78
DO13	● ▲	74	DX4R	● ▲	66	EL1	● ▲ U	76
DO1R	● ▲ U	74	DX5R	▲	66	EL10	▲	76
DO2R	● ▲	74	DX6R	▲	66	EL1C	▲ U	76
DO6	● ▲	74	DX7R	● ▲	66	EL1X	▲	76
DOW1R	●	75	DX8R	● ▲	66	EL2	▲	76
DP1	● ▲	75	DX9R	● ▲	66	EL3	▲	76
DP1R	● ▲	75	DY1	●	64	EL4	● ▲ U	76
DRC1	●	75	DY1R	●	64	EL5R	● ▲	76
DRS1R	●	75	E			EL6	▲	76
DS1	● ▲	74	EA1	● ▲	75	EL7R	● ▲	76
DS1R	● ▲	74	EA2	● ▲	75	EL9	●	76-232
DS2	▲	74	EA3	● ▲	75	ELK1	▲	76
DS3R	● ▲	74	EA4	● ▲	75	ELP1R	▲	76
DS4	● ▲	74	EAS1	●	75	EM1	● ▲	77
DS5R	● ▲	74	EBX1R	▲	78	EM11	▲	77
DS6	● ▲ ■	74-231	EC5	▲ ■	76-182-232-246	EM1R	●	77
DS7	●	74-232	ECM1	● ▲	75	EM2R	● ▲	77
DW1	▲	75				EM3	● ▲	77

● Brass
Ottone
Messing
Laiton
Latón
Latão

▲ Steel
Acciaio
Stahl
Acier
Acero
Aço

■ Nickel silver
Alpaca
Neusilber
Maillechort
Alpaca
Alpaca

◆ Iron
Ferro
Eisen
Fer
Hierro
Ferro

Ⓒ Available in Color
Disponibile in Color
Lieferbar in Color
Disponibile en Color
Disponibile en Color
Disponível em Color

Ⓒ Available in Ultralite
Disponibile in Ultralite
Lieferbar in Ultralite
Disponibile en Ultralite
Disponibile en Ultralite
Disponível em Ultralite

Ⓒ Available in Silky
Disponibile in Silky
Lieferbar in Silky
Disponibile en Silky
Disponibile en Silky
Disponível em Silky

REF.		PAGE	REF.		PAGE	REF.		PAGE
EM3R	● ▲	77	EU6	▲	80	EV4	● ▲ U	80
EM4	● ▲	77	EU7	▲	79	EV4R	● ▲	80
EMK1	● ▲	77	EU9	▲	79	EV4RX	●	80
EMK13	▲	77	EUR1	▲	80	EV4X	●	80
EMK2	▲	77	EUS1	▲	80	EV5	● ▲	80
EMK3R	▲	77	EV10	● ▲ ■ U	80	EV5X	●	80
EMK5	▲	77	EV103X-1	▲	81	EV6	●	81
EMK6R	▲	77	EV103X-10	▲	81	EV64RX	●	80
EN1R	● ▲	77	EV103X-11	▲	81	EV69X	● ▲ G	80
EN2R	● ▲	77	EV103X-12	▲	81	EV6R	● ▲	81
ER1	● ▲	77	EV103X-2	▲	81	EV7	● ▲	81
ER2	▲	77	EV103X-3	▲	81	EV70	●	81
ER3R	▲	77	EV103X-4	▲	81	EV70R	●	81
ER4R	▲	77	EV103X-5	▲	81	EV7R	● ▲	81
ERT1	● ▲	77	EV103X-6	▲	81	EV8	● ▲	81
ES1	▲	77	EV103X-7	▲	81	EV81X	●	80
ES1R	▲	77	EV103X-8	▲	81	EV82X	●	80
ET1	●	78	EV103X-9	▲	81	EV8R	● ▲ U	81
ET1R	●	78	EV106	■	81-233	EV9	● ▲	80
ET2	● ▲	78	EV106R	■	81-233	EV9X	●	80
ET2R	● ▲	78	EV107	■	81-233	EVO1	▲	80
ETA1	● ▲	78	EV107R	■	81-233	EX1	● ▲	81
ETF1	▲	78	EV109X	●	80	EZ1	▲ U	82
EU10	▲	80	EV10X	● ▲ U	80	EZ2R	● ▲ U	82
EU10R	● ▲	80	EV10X1	● ▲ U	80	EZ3	▲ ■	81-233
EU11R	● ▲	78	EV11	● ▲	80	EZ3X	●	81-233
EU12	▲	78	EV110RX	▲	80	EZ4	●	81-233
EU13R	▲	79	EV111RX	▲	80	EZ4X	●	81-233
EU14	▲	79	EV118X	▲	80	EZ5	● S	81-233
EU15	▲	80	EV12	▲	80	EZ5X	●	81-233
EU16R	▲	79	EV122	■	81-233	EZ6	●	81-233
EU17	●	78-233	EV122R	■	81-233	EZ6X	●	81-233
EU18R	▲	78	EV2	● ▲	80	EZ7	▲	82
EU19	▲	78	EV21R	● ▲	81	F		
EU1R	● ▲ U	78	EV22R	● ▲	81	F1	●	89
EU2	▲	79	EV23R	● ▲	81	F1R	● ▲	89
EU20	● ▲	80	EV24R	● ▲	81	F2R	● ▲	89
EU2R	▲	79	EV2X	●	80	FAC10	● ▲	84
EU3	● ▲	78	EV3	● ▲ U	80	FAC10R	● ▲	84
EU4	▲	79	EV3R	● ▲ G	80	FAC11	● ▲	84
EU4R	▲	79	EV3RX	●	80	FAC12	▲	84
EU5R	● ▲	78	EV3X	▲ ■ G	80			

● Brass
Ottone
Messing
Laiton
Latón
Latão

▲ Steel
Acciaio
Stahl
Acier
Acero
Aço

■ Nickel silver
Alpacca
Neusilber
Maillechort
Alpaca
Alpaca

◆ Iron
Ferro
Eisen
Fer
Hierro
Ferro

G Available in Color
Disponibile in Color
Lieferbar in Color
Disponibile en Color
Disponível em Color

U Available in Ultralite
Disponibile in Ultralite
Lieferbar in Ultralite
Disponibile en Ultralite
Disponível em Ultralite

S Available in Silky
Disponibile in Silky
Lieferbar in Silky
Disponibile en Silky
Disponível em Silky

REF.		PAGE	REF.		PAGE	REF.		PAGE
FAC13	▲	84	FB13RX	●▲U	83	FB42R	●▲	82
FAC14	▲	84	FB13X	●	83	FB4R	●▲U	82
FAC15	●■	84-233	FB14R	●▲U	83	FB57R	●	83
FAC1R	▲	84	FB14RX	●▲U	83	FB5R	▲	82
FAC2	●▲	84	FB15R	●▲U	83	FB62RX	●	83
FAC29	▲	84	FB15RX	●▲U	83	FB62X	●	83
FAC2R	●▲	84	FB16R	●▲U	83	FB63X	●▲	83
FAC3	●▲	84	FB16RX	●U	83	FB64RX	●	83
FAC30	▲	84	FB17R	●▲U	83	FB64X	●	83
FAC31	●	84-233	FB17RX	●▲U	83	FB65R	●	83
FAC32	●	84-233	FB17X	●	83	FB69RX	●	83
FAC3R	▲	84	FB18R	●▲U	83	FB6R	●▲U	82
FAC4	●▲	84	FB18RX	●U	83	FB75R	●	83
FAC5	●▲	84	FB19R	●▲U	83	FB7R	●▲U	82
FAC5R	●▲	84	FB19RX	●▲U	83	FB81	●	82
FAC6	●▲	84	FB2	●▲U	82	FB81R	●	82
FAC6R	●▲	84	FB20R	●▲U	83	FB83R	●▲	83
FAC7	●▲U	84	FB20RX	●▲U	83	FB8R	▲	82
FAC8	▲	84	FB20X	●▲	83	FB9	●▲	82
FAC9	●▲U	84	FB21R	●▲U	83	FB97RX	●	83
FAI1R	▲	85	FB21RX	●▲	83	FB98X	●	83
FAI2	▲	85	FB22R	●▲U	83	FD1	●▲	90
FAI3	▲	85	FB22RX	●▲	83	FDR1	●	87
FAM1	●▲	85	FB23	●▲U	82	FDR2	▲	87
FAM1R	●▲	85	FB23R	●▲U	82	FEB1	●	53-87
FAM2	●▲	85	FB24	●▲U	82	FEB1R	●	53-87
FAM2R	●▲	85	FB25R	●▲U	83	FEB2	●▲	53-87
FAM3	●U	85	FB25RX	●▲U	83	FEB2R	●	53-87
FAM5	●U	85	FB26	●▲U	82	FEB6R	●	87
FAM6	●U	85	FB26R	●▲U	82	FF1	●▲U	87
FAM8	●	85	FB27R	●▲	83	FF10	●▲	87
FAM9	●	85	FB28R	●▲U	83	FF10R	●▲	87
FAN1	●▲U	85	FB28RX	●▲	83	FF11	●	88
FB1	●▲U	82	FB31	●	83	FF11R	●	88
FB103	▲	83	FB33	●▲	82	FF12	●▲U	88
FB104R	▲	83	FB33R	●▲	82	FF12R	●▲	88
FB105R	▲	83	FB34R	●▲U	83	FF13	●▲	88
FB108	●	83	FB35R	●▲	83	FF13R	●▲	88
FB10R	●U	82	FB36	●▲	83	FF14	●▲	87
FB11R	●▲U	82	FB36R	●▲	83	FF15	●▲	87
FB12R	●▲U	82	FB39X	●	83	FF16	●	88
FB13R	●▲U	83	FB3R	●▲U	82	FF17	▲	87

● Brass
Ottone
Messing
Laiton
Latón
Latão

▲ Steel
Acciaio
Stahl
Acier
Acero
Aço

■ Nickel silver
Alpaca
Neusilber
Maillechort
Alpaca
Alpaca

◆ Iron
Ferro
Eisen
Fer
Hierro
Ferro

Ⓒ Available in Color
Disponibile in Color
Lieferbar in Color
Disponibile en Color
Disponibile en Color
Disponível em Color

Ⓒ Available in Ultralite
Disponibile in Ultralite
Lieferbar in Ultralite
Disponibile en Ultralite
Disponibile en Ultralite
Disponível em Ultralite

Ⓒ Available in Silky
Disponibile in Silky
Lieferbar in Silky
Disponibile en Silky
Disponibile en Silky
Disponível em Silky

REF.		PAGE	REF.		PAGE	REF.		PAGE
FF18	●	88	FH33	●	92-235	FM3R	● ▲	86
FF19	●	88-234	FH34R	●	92-235	FM4	● ▲	86
FF1R	● ▲	87	FH35	●	92-235	FM4R	● ▲	86
FF2	● ▲ U	87	FH36	●	92-235	FM5	● ▲	86
FF3	● ▲	87	FH37R	●	92-234	FM5P	● ▲	86
FF3R	● ▲	87	FH3R	▲	91	FM6	● ▲ U	86
FF4	● ▲	88	FH4	▲	91	FM7	● ▲	86
FF4R	●	88	FH4R	▲	91	FM8	●	86
FF5	●	88	FH5	▲	91	FMK1	● ▲	67
FF5R	● ▲	88	FH6	▲ U	91	FN1	●	85
FF6	● ▲	88	FH7	● ▲	90	FN2	●	85
FF6R	● ▲	88	FH8R	▲	91	FN4	●	85
FF7	● ▲	87	FH9	▲	91	FOS1	▲	90
FF7R	● ▲	87	FH9R	▲	91	FRE1R	▲	90
FF8	▲	87	FI064	● ▲	88	FRN1R	●	87
FF8R	● ▲	87	FI065	● ▲	88	FRT1	● ▲	90
FF9	● ▲	87	FI1	●	88	FRT4R	▲	90
FF9R	● ▲	87	FI1R	●	88	FRT5R	▲	90
FH1	▲	91	FI2	●	88	FRT6R	●	90
FH10R	▲	91	FI232	● ▲	88	FRT7	▲	90
FH11	▲	91	FI233	● ▲	88	FRT8	▲	90
FH12	●	92-234	FI234	● ▲	88	FRT9R	▲	90
FH13	▲	91	FI235	● ▲	88	FRZ1	● U	90
FH14	▲	91	FI3R	●	88-234	FRZ2	●	90
FH15	▲	91	FI4R	●	88-234	FS1	● ▲	85
FH16R	▲	91	FI6	●	88	FS1R	● ▲	85
FH17R	●	92-234	FID1	● ▲	89	FT15R	▲	89
FH18	▲	91	FIR1	▲	89	FT3	▲	89
FH19R	▲	91	FIR1R	▲	89	FT4	▲	89
FH1R	▲	91	FIR2R	▲	89	FT4C	▲	89
FH2	▲	91	FIR3	▲	89	FT500	●	89
FH20R	● ▲	91	FIS1	● ▲	90	FT500C	●	89
FH21R	▲	92	FIS1R	● ▲	90	FT510	●	89
FH22R	▲	92	FIS3	● ▲	90	FT5C	▲	89
FH23R	▲	92	FK1	● ▲	90	FU1	▲	92
FH24R	●	92	FL2	▲	90	FV1	▲	87
FH25	▲	91	FL2R	▲	90	FV2	▲	87
FH2R	▲	91	FLM1P	■	90	FV4	●	87-234
FH3	▲	91	FM090	● ▲ U C S	86	FVR1	●	86-234
FH30	▲	91	FM1	● ▲ U C	86	FVR2R	●	86-234
FH31L	● ▲	91	FM2	● ▲ U	86	FVR3	●	86-234
FH32	●	92-234	FM3	● ▲	86	FVR4R	●	86-234

● Brass
Ottone
Messing
Laiton
Latón
Latão

▲ Steel
Acciaio
Stahl
Acier
Acero
Aço

■ Nickel silver
Alpacca
Neusilber
Maillechort
Alpaca
Alpaca

◆ Iron
Ferro
Eisen
Fer
Hierro
Ferro

Ⓒ Available in Color
Disponibile in Color
Lieferbar in Color
Disponibile en Color
Disponibile en Color
Disponível em Color

Ⓘ Available in Ultralite
Disponibile in Ultralite
Lieferbar in Ultralite
Disponibile en Ultralite
Disponibile en Ultralite
Disponível em Ultralite

Ⓔ Available in Silky
Disponibile in Silky
Lieferbar in Silky
Disponibile en Silky
Disponibile en Silky
Disponível em Silky

REF.		PAGE	REF.		PAGE	REF.		PAGE
FY1R	●	86-234	GE178RX-2	▲	94	GE4R	● ▲	93
G			GE178RX-3	▲	94	GE4RX	●	94
GAT1R	●	93-235	GE178RX-4	▲	94	GE4X	●	94
GB1	● ▲	93	GE178RX-5	▲	94	GE52X	● ▲	94
GB2	● ▲	93	GE178RX-6	▲	94	GE57	■	93-235
GB3	● ▲	93	GE178RX-7	▲	94	GE7R	● ▲ U	93
GB5	● ▲	93	GE17R	● ▲	94	GE7RX	● C	94
GB5R	●	93	GE18	● ▲	94	GE8R	● ▲ C	93
GBA1	▲	93	GE182X	▲	94	GE9	● ▲	93
GBL1R	▲	97	GE19R	● ▲	94	GEA4	●	93
GD1	▲	100	GE1R	● ▲	93	GF1	●	100-236
GD10	●	100	GE1RX	●	94	GJ3	●	98
GD10R	●	100	GE1X	● ▲ ■ U C	94	GL1	● ▲	98
GD1R	● ▲	100	GE2	● ▲	94	GL10	● ▲	97
GD2	▲	100	GE20	●	94	GL10R	●	97
GD3	●	100	GE21R	● ▲	94	GL11R	● ▲	97
GD4	● ▲	100	GE22	●	94	GL12R	● ▲	97
GD5	● ▲	100	GE23	●	94	GL13R	● ▲	97
GD6R	● ▲	100	GE23R	●	94	GL14	● ▲ U	98
GD7R	● ▲	100	GE24	●	94	GL17R	● ▲	97
GD8	● ▲ U	100	GE24R	●	94	GL18R	▲	98
GD8R	● ▲ U	100	GE25	●	94	GL19R	● ▲	98
GE1	● ▲ ■ U	93	GE25R	● ▲	94	GL1R	▲	98
GE106	● ▲	94	GE26	●	94	GL2	● ▲	97
GE106XL	●	94	GE26R	●	94	GL20	●	99
GE118	●	94	GE27	●	94	GL21R	●	98
GE119	●	93	GE27R	●	94	GL22R	●	98
GE119X	●	94	GE28	● ▲	94	GL2R	● ▲	97
GE14	● ▲	94	GE28R	●	94	GL3	● ▲	97
GE15	●	94	GE29	●	94	GL3R	● ▲	97
GE15R	● ▲	94	GE29R	●	94	GL4	● ▲	97
GE16	●	94	GE2R	● ▲	94	GL4R	●	97
GE16R	● ▲	94	GE3	● ■ U	94	GL5	● ▲	97
GE17	● ▲	94	GE30	● ▲	94	GL5R	●	97
GE178RX-1	▲	94	GE30R	●	94	GL6	● ▲ U	97
GE178RX-11	▲	94	GE31	● ▲	94	GL6R	● ▲	97
GE178RX-12	▲	94	GE31R	● ▲	94	GL7	● ▲ U	97
GE178RX-13	▲	94	GE32	● ▲	94	GL7R	● ▲	97
GE178RX-15	▲	94	GE34	●	93	GL8	● ▲ U	97
GE178RX-16	▲	94	GE34X	●	94	GL9	● ▲	97
GE178RX-17	▲	94	GE3R	▲	94	GL9R	● ▲	97
			GE4	● ▲	93	GLZ1	▲	97

● Brass
Ottone
Messing
Laiton
Latón
Latão

▲ Steel
Acciaio
Stahl
Acier
Acero
Aço

■ Nickel silver
Alpaca
Neusilber
Maillechort
Alpaca
Alpaca

◆ Iron
Ferro
Eisen
Fer
Hierro
Ferro

C Available in Color
Disponibile in Color
Lieferbar in Color
Disponibile en Color
Disponibile en Color
Disponível em Color

U Available in Ultralite
Disponibile in Ultralite
Lieferbar in Ultralite
Disponibile en Ultralite
Disponibile en Ultralite
Disponível em Ultralite

S Available in Silky
Disponibile in Silky
Lieferbar in Silky
Disponibile en Silky
Disponibile en Silky
Disponível em Silky

REF.		PAGE	REF.		PAGE	REF.		PAGE
GN1	● ▲	96	GS6	● ▲	96	GYE8	▲	216
GO1R	▲	98	GS7	● ▲	96	GYF	● ▲	216
GO2R	▲	98	GS8	● ▲	96	GYF6	● ▲	217
GO3	●	98	GS9	●	96	GYF7	● ▲	216
GO4R	● U	98	GSS1	●	100	GYF8	● ▲	216
GO5	●	98	GT1	● ▲	96	GYG	●	216
GO6	■	98-235	GT1R	●	96	GYG6	●	217
GO7	■	98-235	GT3	●	96	GYG7	● ▲	216
GOD4R	▲	98	GT3R	●	96	GYG8	▲	216
GP1	● ▲	96	GT4	● ▲	46-95	GYGB7	●	216
GPI1	●	99-235	GT4R	● ▲	46-95	GYH	●	216
GR15	●	95	GUR1	●	101	GYH6	● ▲	217
GR16	▲	95	GUS1	▲	101	GYH7	▲	216
GR1R	▲	95	GV1	▲	100	GYH8	▲	216
GR2R	▲	95	GV2	▲	100	GYK	● ▲	216
GR3	●	95	GV3	▲	100	GYK6	● ▲	217
GR4	●	95	GV4R	▲	100	GYK7	● ▲	216
GR9-5	▲	95	GV5R	▲	100	GYK8	▲	216
GR9-7	▲	95	GV6R	▲	100	GYP5A	● ▲	216
GR9-8	▲	95	GV7	▲	100	GYP5B	▲	216
GR9-9	▲	95	GVY1R	●	95-235	GYP5D	● ▲	216
GR9R-1	▲	95	GVY2R	●	95-235	GYP6B	▲	217
GR9R-2	▲	95	GWS1	●	95	GYP7	● ▲	216
GR9R-3	▲	95	GYA	●	216	GYP7R	●	216
GR9R-4	▲	95	GYA6	●	217	GYP8	●	216
GR9R-5	▲	95	GYA7	● ▲	216	GYP8R	●	216
GR9R-6	▲	95	GYA8	●	216	H		
GS1	● ▲ U	96	GYB	●	216	H1	● ▲	102
GS10	● ▲	96	GYB6	●	217	H1R	▲	102
GS10R	● ▲	96	GYB7	● ▲	216	HA1R	●	101
GS11R	● ▲	96	GYB8	●	216	HAG1	● U	101
GS12R	●	96	GYC	● ▲	216	HAG1R	● U	101
GS13	● ▲	96	GYC6	●	217	HAG5	●	101
GS17	●	96-235	GYC7	● ▲	216	HAG6R	●	101
GS1R	● ▲	96	GYC8	●	216	HAG7	●	101
GS2	● ▲	96-141	GYD	●	216	HAG7R	●	101
GS2R	●	96-141	GYD6	●	217	HAK1	● ▲	116
GS3	● ▲	38-96	GYD7	● ▲	216	HAK2	● ▲	116
GS3R	● ▲	38-96	GYD8	▲	216	HAK3	▲	116
GS4	● ▲	96	GYE	● ▲	216	HAK4	▲	116
GS4R	● ▲	65-96	GYE6	●	217	HAK6	▲	116
GS5	● ▲	96	GYE7	● ▲	216			

● Brass
Ottone
Messing
Laiton
Latón
Latão

▲ Steel
Acciaio
Stahl
Acier
Acero
Aço

■ Nickel silver
Alpacca
Neusilber
Maillechort
Alpaca
Alpaca

◆ Iron
Ferro
Eisen
Fer
Hierro
Ferro

Ⓒ Available in Color
Disponibile in Color
Lieferbar in Color
Disponibile en Color
Disponibile en Color
Disponível em Color

U Available in Ultralite
Disponibile in Ultralite
Lieferbar in Ultralite
Disponibile en Ultralite
Disponibile en Ultralite
Disponível em Ultralite

Ⓔ Available in Silky
Disponibile in Silky
Lieferbar in Silky
Disponibile en Silky
Disponibile en Silky
Disponível em Silky

REF.		PAGE	REF.		PAGE	REF.		PAGE
HCT1R	▲	102	HO2R	●▲U	103	ID3	●	107
HD1	●▲	103	HOK1R	●	102-236	IE1	●▲	108
HD1R	●▲	103	HOK2R	●	102-236	IE10	●▲	108
HD2	●	103	HP1R	▲	101	IE12	●▲	108
HD2R	●▲	103	HPP1	▲	103	IE13	▲	108
HD3	▲	103	HPP1R	●▲	103	IE14	●U	108-236
HD8R	▲	103	HR1	●▲U	103	IE15	●G	108-236
HDL1R	●U	102	HS1R	●▲	101	IE1R	●	108
HDL3	●	101	HT1	●▲	103	IE2	●▲U	108
HDL3R	●	101	HT1R	●▲	103	IE224	●▲U	108
HE1	▲	102	HT2	●▲	103	IE225	●▲U	108
HE1R	▲	102	HTE1	●	103-236	IE26	●S	109-237
HE2	●▲	102	HUT1	●	104	IE26P	●	109-237
HE2R	●▲	102	HW1	●▲	104	IE27R	●▲	108
HE3	●▲	102	HW15R	▲	104	IE28R	●	108
HE3R	●▲	102	HW1P	●	104	IE29	▲	108
HEN1	●▲	102	HW2	▲	104	IE2R	●▲U	108
HF1R	●▲	101	HW21R	●	104	IE3	●▲UGS	108
HF73R	▲	101	HW3	▲	104	IE30	●	109-236
HF74	●▲	101	HW4	●▲	104	IE31	●▲	108
HF74R	▲	101	HW4R	●▲	104	IE3R	●▲	108
HF75	▲	101	I			IE4	●U	108
HF75R	●▲	101	IAB7	●	107	IE4R	●	108
HG1	●▲	103	IAB8	●	107	IE5	●▲G	108
HG2	●▲	103	IAB9	●	107	IE5R	●	108
HG3	●▲	103	IB1	●▲U	108	IE6	●▲UGS	108
HG4	●▲	103	IBF1	●▲	104	IE6R	●▲U	108
HG5	●▲	103	IBF1R	●▲	104	IE6X	▲	108
HG6	●▲	103	IBF2R	●	104-236	IE7	●▲US	108
HGO1R	●	104-236	IBF3R	●	104-236	IE7R	▲U	108
HGO2R	▲	104	IBM1	▲	105	IE8	●	108
HL1R	●	102	ICA1R	▲	105	IE8R	●▲	108
HN1	●▲	102	ICS1	●	105	IE9	●▲	108
HN1P	●	102	ICS1R	●	105	IEH1	●	212
HN2	●▲	102	ICS2	●▲	105	IES1R	●	105
HN3	▲	102	ICS2R	●▲	105	IF1	▲	105
HN3R	▲	102	ICS3	●	105	IF12R	▲	106
HN4	▲	102	ICS3R	●	105	IF13R	▲	106
HN5R	▲	102	ICS5	▲	105	IF14	●	106-236
HN6	▲	102	ID1	●▲	107	IF2	▲U	105
HN7	▲	102	ID2	▲	107	IF2R	▲	105
HO1R	●▲	103				IF3	●▲U	105

● Brass
Ottone
Messing
Laiton
Latón
Latão

▲ Steel
Acciaio
Stahl
Acier
Acero
Aço

■ Nickel silver
Alpaca
Neusilber
Maillechort
Alpaca
Alpaca

◆ Iron
Ferro
Eisen
Fer
Hierro
Ferro

Ⓒ Available in Color
Disponibile in Color
Lieferbar in Color
Disponibile en Color
Disponível em Color

⒰ Available in Ultralite
Disponibile in Ultralite
Lieferbar in Ultralite
Disponibile en Ultralite
Disponível em Ultralite

Ⓔ Available in Silky
Disponibile in Silky
Lieferbar in Silky
Disponibile en Silky
Disponível em Silky

REF.		PAGE	REF.		PAGE	REF.		PAGE
IF3R	▲	105	ITO2	● ▲	109	JOW5	● ▲	110
IF4	● ▲	106	ITO3	●	109	JOW6	▲	110
IF4R	● ▲	106	ITO3R	●	109	JOW7	● ▲	110
IF5	● ▲	106	IW1R	●	109	JOW8	▲	110
IF5R	● ▲	106	IX1	● ▲	104	JOW9	▲	110
IF6	● ▲ U	105	IX1R	● ▲	104	JPN1	● ▲	109
IF7	▲	105	J			JPN2	● ▲	109
IF7R	▲	105	JAR1	● ▲	110	JPN3R	● ▲	109
IF8	▲	105	JAR1R	● ▲	110	JR1R	▲	111
IF8R	▲	105	JAR2	● ▲	110	JS1	● ▲	110
IJ1	▲	106	JAR2R	● ▲	110	JS1R	● ▲	110
IL1	● ▲	106	JB1	▲	109	JS2	● ▲ U S	110
IL1R	● ▲	106	JC1	● ▲	112	JS2R	● ▲	110
ILC13R	●	106	JC2R	● ▲	112	JS3	● ▲	110
ILC2	●	106	JH1	●	110	JS3R	● ▲	110
ILC3	● ▲	106	JL1	▲	113	JS4	● ▲	110
ILC6	●	106	JL2	● ▲	113	JS4R	● ▲	110
ILS1	●	107	JL2R	● ▲	113	JS5P	●	110
IN1	● ▲	106	JL3	●	112	JT1	▲	111
IN2	● ▲	106	JL3R	● ▲	112	JT2R	▲	111
IN3	● ▲	106	JL4	● ▲	113	JT3R	▲	111
IN5	●	107	JL4R	● ▲	113	JU1	● ▲	112
ING1	● ▲	107	JL5	● ▲	113	JU10	▲	112
ING2	● ▲	107	JM1	● ▲	6-111	JU11	● ▲	111
ING3	▲	107	JM1R	▲	6-111	JU11R	● ▲	111
ING4R	●	107	JM2	● ▲	6-111	JU12	● ▲	111
ING5	● ▲	107	JM2R	▲ U C S	6-111	JU13R	● ▲	111
ING6	● ▲	107	JM3	● ▲	111	JU14	▲	111
INS1	● ▲	107	JM3R	▲	111	JU1R	▲	112
INS1R	● ▲	107	JM6	▲	111	JU2	▲	112
IO1	●	109-237	JM7	▲	111	JU2R	▲	112
IO2R	●	109-237	JN1R	● ▲	111	JU3	● ▲	111
IR1	●	108-236	JOW1	● ▲	110	JU4	● ▲	111
IS1	● ▲	106	JOW10	▲	110	JU5	● ▲	111
IS2	● ▲	106	JOW11	● ▲	110	JU6	● ▲	111
ISP2	● ▲	105	JOW12RX	▲	110	JU7	● ▲	112
ISP4	● ▲	105	JOW12X	▲	110	JU8	▲	111
IT1	● ▲	107	JOW1R	▲	110	JU9	▲	111
IT1R	● ▲	107	JOW2	● ▲	110	JW1	●	112
IT2	● ▲	108	JOW3R	● ▲	111	JW10	● ▲	112
IT2R	● ▲	108	JOW4R	▲	111	JW10R	● ▲	112
ITO1R	●	109				JW11	● ▲	112

● Brass
Ottone
Messing
Laiton
Latón
Latão

▲ Steel
Acciaio
Stahl
Acier
Acero
Aço

■ Nickel silver
Alpacca
Neusilber
Maillechort
Alpaca
Alpaca

◆ Iron
Ferro
Eisen
Fer
Hierro
Ferro

Ⓒ Available in Color
Disponibile in Color
Lieferbar in Color
Disponibile en Color
Disponibile en Color
Disponível em Color

Ⓘ Available in Ultralite
Disponibile in Ultralite
Lieferbar in Ultralite
Disponibile en Ultralite
Disponibile en Ultralite
Disponível em Ultralite

Ⓔ Available in Silky
Disponibile in Silky
Lieferbar in Silky
Disponibile en Silky
Disponibile en Silky
Disponível em Silky

REF.		PAGE	REF.		PAGE	REF.		PAGE
JW12	● ▲	112	KE1	● ■ C	115-238	KI13	● ▲	117
JW13	● ▲	112	KE11	■	116-238	KI14	▲	117
JW13R	● ▲	112	KE13	■ S	116-238	KI15	▲	117
JW1R	●	112	KE19	■	116-239	KI15R	▲	117
JW2	● ▲	112	KE2	■	115-238	KI16	● ▲	117
JW2R	●	112	KE3	● ■ U C	115-238	KI4	● ▲	117
JW3	● ▲	112	KE4	■	115-165-238-244	KI4R	● ▲	117
JW4	●	112	KE9	■ C	115-238	KI5	● ▲	117-159
JW4R	● ▲	112	KE1R	●	115	KI5R	● ▲	117-159
JW5	● ▲	112	KER1	▲	116	KI6	● ▲	117
JW5R	● ▲	112	KEY1	▲	116	KI7	▲	117-159
JW6	●	112	KEY1R	▲	116	KI7R	● ▲	117
JW6R	● ▲	112	KEY2	▲	116	KI8	▲	93-117
JW7	●	112	KF1	● ▲ U C	116	KI8R	▲	93-117
JW7R	● ▲	112	KFA	● ▲	116	KI9	● ▲	117
JW8	● ▲	112	KFB	● ▲	116	KI9R	● ▲	117
JW9	● ▲	112	KFC	● ▲	116	KIR1	▲	118
JW9R	● ▲	112	KFD	● ▲	116	KIV1R	▲	118
K			KFE	● ▲	116	KIV2R	▲	118
KA1	● ■ U C S	113-237	KFF	● ▲	116	KK1	● ▲	207
KA2	● ■	113-237	KFG	● ▲	116	KL1	● ▲	118
KA3	● ■	113-237	KFH	● ▲	116	KL1R	● ▲	118
KA4	■	113-237	KFI	● ▲	116	KL2	▲	118
KA5	● ■	113-237	KFJ	● ▲	116	KL2R	● ▲	118
KA6	■	113-237	KFK	● ▲	116	KLE1	● U	114-238
KA7	■	113-237	KFL	● ▲	116	KLE10R	● U	114-238
KA8	■	113-237	KFM	● ▲	116	KLE11	● U	114-238
KA9	● ■	113-237	KFN	● ▲	116	KLE2R	●	114-238
KAK1	■	114-238	KFO	● ▲	116	KLE3R	● ▲ U	114
KAP1	● ▲	114	KFR	● ▲	116	KLE3RX	▲	114
KAP1R	● ▲	114	KFS	● ▲	116	KLE3X	▲	114
KAX1	●	113-237	KFU	● ▲	116	KLE4	● U	114-238
KAX1R	●	113-237	KFW	● ▲	116	KLE5RX	▲	114
KAZ1R	▲	115	KFX	● ▲	116	KLE5X	▲	114
KAZ2	▲	115	KG1	● ▲	118	KLE6RX	▲ U	114
KAZ2R	▲	115	KG2	●	118	KLE6X	▲	114
KAZ3R	▲	115	KI10	▲	93-117	KLE7RX	● ▲ U S	114
KAZ4R	▲	115	KI10R	▲	93-117	KLE7X	● ▲ U	114
KAZ5R	▲	115	KI11	● ▲	117	KLE8R	●	114-238
KAZ7R	▲	115	KI11R	▲	117	KLE9R	●	114-238
KAZ8R	▲	115	KI12	● ▲	117-159	KL1G1R	▲	114
			KI12R	▲	117-159	KL1G2R	▲	114

● Brass
Ottone
Messing
Laiton
Latón
Latão

▲ Steel
Acciaio
Stahl
Acier
Acero
Aço

■ Nickel silver
Alpaca
Neusilber
Maillechort
Alpaca
Alpaca

◆ Iron
Ferro
Eisen
Fer
Hierro
Ferro

C Available in Color
Disponibile in Color
Lieferbar in Color
Disponibile en Color
Disponibile en Color
Disponível em Color

U Available in Ultralite
Disponibile in Ultralite
Lieferbar in Ultralite
Disponibile en Ultralite
Disponibile en Ultralite
Disponível em Ultralite

S Available in Silky
Disponibile in Silky
Lieferbar in Silky
Disponibile en Silky
Disponibile en Silky
Disponível em Silky

REF.		PAGE	REF.		PAGE	REF.		PAGE
KM1	▲	118	LC11	●▲ⓄⓈ	123	LF11R	●▲	79-128
KM1R	●▲	118	LC11R	▲Ⓞ	123	LF13	▲	79-128
KMT1	▲	118	LC12	▲	123	LF15R	▲	79-128
KMT2R	▲	118	LC13	▲	123	LF16	●▲	79-128
KNA1	●▲	119	LC13R	▲	123	LF16R	●▲	79-128
KNA2	▲	119	LC14R	●■Ⓢ	123-239	LF17	▲	79-128
KOB1	▲	118	LC15	▲	123	LF18R	●▲	79-128
KP1	●	118	LC15R	▲	123	LF2	●▲Ⓞ	79-128
KPP1	▲	118	LC16	▲	123	LF20	●▲	79-128
KRE1	▲	118	LC17	▲	123	LF20R	●▲	79-128
KS1	●▲Ⓞ	119	LC17R	▲	123	LF22	●▲	79-128
KS1FT	●▲Ⓞ	119	LC1R	▲	123	LF22R	●▲	79
KS4	●Ⓞ	119	LC2	●▲Ⓞ	123	LF23R	●▲	79
KZ1	▲	117	LC25	▲	123	LF24	●▲Ⓞ	129
KZ2	▲	117	LC25R	▲	123	LF25	●▲Ⓞ	129
KZ3	▲	117	LC26R	●	123-239	LF26	●▲	79-128
L			LC2R	▲Ⓞ	123	LF27	●▲Ⓞ	129
LAF1	●Ⓞ	119	LC3	▲Ⓞ	123	LF27R	●	129
LAF2	●Ⓞ	119	LC3R	▲Ⓞ	123	LF28R	▲	129
LAF4R	●	119	LC4	▲	123	LF29R	▲	79-129
LAF5	●	120	LC4R	▲	123	LF30R	●▲	79-129
LAF6	●	120	LC5	▲	123	LF31R	●▲Ⓞ	129
LAF7	●	120	LC5R	●▲	123	LF33	▲	129
LAF8	●	120	LC6	▲	123	LF34	●▲	129
LAP1	●▲	121	LC6R	▲	123	LF37	●▲	129
LAP2	▲	67-121	LC7	▲	123	LF39	●▲Ⓞ	129
LAP3	▲	67-121	LC7R	▲	123	LF4	●▲Ⓞ	79-128
LB10	●▲■	122	LC8	●▲	123	LF42R	▲	128
LB11	●▲	122	LC8R	▲	123	LF43R	●▲Ⓞ	129
LB18	●▲	122	LC9	▲	123	LF44	●▲	130
LB19	●▲	122	LC9R	▲	123	LF45R	●▲	130
LB22	●▲	122	LCK1R	●▲	126-239	LF46R	●▲	130
LB23	●▲	122	LCK1RX	●	126-239	LF47	▲	129
LB28	●	122	LD4	▲	119	LF4R	▲	79-128
LB29	●	122	LD4R	▲	119	LF51R	▲	129
LB32	●▲	122	LD5R	●▲	119	LF52	▲	128
LB33	●▲■	122	LEA1	●	122-239	LF53	▲	130
LB34	●▲■	122	LEA2	▲	122	LF54	●	129
LB35	●▲	122	LEG1	●▲	122	LF56	▲	130
LC1	▲	123	LEG2	●▲	122	LF57	●	128
LC10	▲	123	LEG3	●▲	122	LF58R	▲	130
			LF11	●▲	79-128	LF59R	▲	130

● Brass
Ottone
Messing
Laiton
Latón
Latão

▲ Steel
Acciaio
Stahl
Acier
Acero
Aço

■ Nickel silver
Alpacca
Neusilber
Maillechort
Alpaca
Alpaca

◆ Iron
Ferro
Eisen
Fer
Hierro
Ferro

Ⓞ Available in Color
Disponibile in Color
Lieferbar in Color
Disponibile en Color
Disponível em Color

Ⓞ Available in Ultralite
Disponibile in Ultralite
Lieferbar in Ultralite
Disponibile en Ultralite
Disponível em Ultralite

Ⓢ Available in Silky
Disponibile in Silky
Lieferbar in Silky
Disponibile en Silky
Disponível em Silky

REF.		PAGE	REF.		PAGE	REF.		PAGE
LF6	●▲U	79-128	LM4R	▲	130	LP39R	●▲	124
LF60	●▲	130	LM5P	▲	130	LP3R	▲	124
LF61R	●▲	129	LMA1	▲	120	LP40	▲	124
LF62	●	129	LN1	●	125	LP41	▲	124
LF6R	●▲U	79-128	LOB1	▲	125	LP42	●	124
LF7	▲	79-128	LOB10R	▲	125	LP43	●▲	124
LF8	●▲	79-128	LOB11R	●	125	LP44	●	124
LF8R	▲	79-128	LOB13	▲	126	LP45	●	124
LH1	●▲U	120	LOB16	●	126	LP48	●▲	124
LH10	●▲	121	LOB1R	●▲U	125	LP49	●▲	124
LH10R	▲	121	LOB9R	▲	125	LP5	●▲UGS	124
LH13P	■	120-239	LOC1	●U	126	LP50	●▲	124
LH14P	■	120-239	LOC3	●	126	LP51	●▲	124
LH15P	■	120-239	LOC4	●	126	LP52	●▲	124
LH16P	■	120-239	LOK2	●	128-239	LP53	●▲	124
LH17P	■	120-239	LP10	●▲	124	LP57R	●▲	124
LH18P	■	120-239	LP10R	●▲	124	LP5R	●▲	124
LH2	●▲	121	LP11	■	115-124-238-239	LP6	●▲	125
LH20	▲	121	LP12	●▲	124	LP7	▲	124
LH21	▲	121	LP12R	●▲	124	LP7R	▲	124
LH22	▲	121	LP13	▲	124	LP8	▲	124
LH23	▲	121	LP13R	▲	124	LP8R	●▲	124
LH24	▲	121	LP14	●▲	125	LP9	●▲	124
LH25	▲	121	LP14R	●▲	125	LP9R	●▲	124
LH26	▲	121	LP15	●▲	125	LS1	●▲	121-159
LH27	▲	121	LP15R	●▲	125	LS10	▲	121
LH28	▲	121	LP16	●▲	125	LS11	●▲	122
LH29	▲	121	LP16R	●	125	LS11R	●▲	122
LH3	▲	121	LP17R	●▲	124	LS12	▲	121
LH4	▲	120	LP18R	●▲	124	LS13	●▲U	122
LH40	▲	120	LP19R	●▲	124	LS13R	●▲	122
LH41P	■	120-239	LP2	●▲	124	LS14	●▲	122
LH42	▲	120	LP20R	▲	124	LS14R	●▲	122
LH43R	▲	120	LP21	●▲■UGS	124	LS15	●▲	122
LH5	●▲	121	LP21-OV	●▲U	124	LS17	●▲	122
LH5R	▲	121	LP2R	●▲	124	LS18	●▲	122
LH6R	●▲	121	LP3	▲U	124	LS19	●▲	121
LH7R	●▲	121	LP35R	●	124	LS1R	●▲	121-159
LL1	●▲	122-126	LP36R	●	124	LS2	●▲	121-159
LM3	▲	130	LP37R	●	124	LS3	▲	121
LM3R	▲	130	LP38R	●▲	124	LS3R	▲	121
LM4	▲	130	LP39	●	124	LS4	▲	121

● Brass
Ottone
Messing
Laiton
Latón
Latão

▲ Steel
Acciaio
Stahl
Acier
Acero
Aço

■ Nickel silver
Alpaca
Neusilber
Maillechort
Alpaca
Alpaca

◆ Iron
Ferro
Eisen
Fer
Hierro
Ferro

Ⓒ Available in Color
Disponibile in Color
Lieferbar in Color
Disponibile en Color
Disponibile en Color
Disponível em Color

Ⓢ Available in Ultralite
Disponibile in Ultralite
Lieferbar in Ultralite
Disponibile en Ultralite
Disponibile en Ultralite
Disponível em Ultralite

Ⓣ Available in Silky
Disponibile in Silky
Lieferbar in Silky
Disponibile en Silky
Disponibile en Silky
Disponível em Silky

REF.		PAGE	REF.		PAGE	REF.		PAGE
LS4R	▲	121	LW4R	●▲U	127	MAU5R	▲	132
LS5	▲	122	LW5	●▲U	127	MAY1	●	133
LS6	▲	122	LW5R	●	127	MB1	●	141
LS7	●▲	121	LW6	●▲	127	MBL1	●▲	141
LS9	●▲	122	LW7	●▲	127	MBL1R	●▲	141
LS9R	●▲	122	LW8	●▲	127	MBS300	●	270
LT1	●▲	35-125	LW9	●▲	127	MBS301	●	270
LT2	●▲U	125	LX1	▲	130	MC1	●▲	133
LT3	▲	125	LX1R	▲	130	MC10R	●	134-240
LT4	●▲U	125	LXM1R	▲	130	MC11	▲	134
LT5	●	125	LYA	●	217	MC12	●▲U	134
LT6R	●	125	LYA6	●▲	217	MC13	▲	134
LU1	●▲	130	LYB	●▲	217	MC14R	●	134-240
LU2	●▲U	130	LYB6	●	217	MC15R	●	134-240
LU3R	●▲U	130	LYC	●▲	217	MC17	▲	133
LU4	▲U	130	LYC6	●▲	217	MC18R	●	134
LW1	●▲	127	LYD	●	217	MC19R	●	134
LW10	●▲	127	LYD6	●▲	217	MC1R	●	133
LW11	●▲	127	LYE	●	217	MC2	●▲U	133
LW12R	●▲	128	LYE6	●	217	MC20	▲	134
LW13	●▲	128	LYF	●▲	217	MC21	▲	134
LW14	●▲U	128	LYF1T	●	130	MC22	▲	133
LW15	●▲	128	LYF2T	●	130	MC22R	▲	133
LW16	●▲	126	LYF6	●▲	217	MC23	▲	133
LW17	●▲	126	LYG	●	217	MC24	▲	134
LW18	●▲U	127	LYG6	●▲	217	MC25	▲	134
LW19	●	127	LYH	●	217	MC26R	●	134-240
LW1R	●▲	127	LYH6	●▲	217	MC2R	●▲U	133
LW2	●▲U	127	LYK	●▲	217	MC3	▲U	133
LW20	●▲	127	LYK6	●	217	MC4	▲U	133
LW20R	●▲	127	LYP5A	●▲	217	MC4R	●▲	133
LW21R	●▲	127	LYP5B	▲	217	MC5	●▲	133
LW23	●	127	LYP5D	▲	217	MC5R	●▲U	133
LW24	●▲	127	LYP6A	▲	217	MC6	●▲	133
LW28	●	127	LYP6D	▲	217	MC6R	●▲	133
LW29	●	127				MC7	▲	133
LW2R	●▲	127				MC8	▲	133
LW3	●▲U	128				MC9X	●	134-240
LW34	●	126				MD11	■	135
LW4	●▲UCS	127				MD1R	●▲■	135
LW40	●	127				MD4	●■	135
LW40R	●▲	127				MD6	●	135

● Brass
Ottone
Messing
Laiton
Latón
Latão

▲ Steel
Acciaio
Stahl
Acier
Acero
Aço

■ Nickel silver
Alpacca
Neusilber
Maillechort
Alpaca
Alpaca

◆ Iron
Ferro
Eisen
Fer
Hierro
Ferro

Ⓒ Available in Color
Disponibile in Color
Lieferbar in Color
Disponibile en Color
Disponibile en Color
Disponível em Color

Ⓘ Available in Ultralite
Disponibile in Ultralite
Lieferbar in Ultralite
Disponibile en Ultralite
Disponibile en Ultralite
Disponível em Ultralite

Ⓔ Available in Silky
Disponibile in Silky
Lieferbar in Silky
Disponibile en Silky
Disponibile en Silky
Disponível em Silky

REF.		PAGE	REF.		PAGE	REF.		PAGE
MD7	●	135	MER34R	● ▲	138	MI3	● ▲	142
MD8R	●	135	MER35R	● ▲	138	MI3R	● ▲	142
ME1	▲	135	MER36	●	138	MI5	● ▲	142
ME10R	● ▲	136	MER37	●	138	MI5R	● ▲	142
ME2R	▲	135	MER38	●	138-241	MI7	▲	142
ME3	▲	135	MER39	●	138-241	MI7R	▲	142
ME4	● ▲	135	MER4	● ▲	136	MI8	●	142
ME4R	▲	135	MER41	●	138	MIG1	● ▲	142
ME5	▲	135	MER42R	▲	138	MIG1R	● ▲	142
ME5R	▲	135	MER4R	● ▲	136	MIG2	● ▲	142
ME6	● ▲	135	MER5	● ▲	136	MIG2R	● ▲	142
ME7	▲	135	MER6	● ▲	136	MIL1	▲	139
ME8	▲	135	MER6R	● ▲	136	MIL2	▲	139
ME9	▲	136	MER7R	●	136	MIS1	◆	140-269
MEC1	● ▲	135	MER8	● ▲ U C S	137	MIS2	◆	140-269
MEG1R	●	135-241	MER9R	●	137	MIW1	● ◆	140
MEG2	▲	135	MET1	▲	139-150	MIW13	●	140
MER1	● ▲ C	136	MF1R	● ▲	135	MIW14	● ■	140
MER10R	●	137	MFA1	▲	135	MIW15	■	140
MER11R	● ▲	137	MG1	● ▲	139	MIW2	●	140
MER12R	●	137	MG1R	● ▲	139	MIW3	● ■	140
MER13R	● ▲ U	137	MG2	●	139	MIW4	●	140
MER14R	●	137	MG2R	● ▲	139	MIW5	●	140
MER15R	●	137	MG3	●	139	MIW6	●	140
MER16R	●	137	MG3R	● ▲	139	MIW7	●	140
MER17R	● ▲	137	MG8	●	139-241	MLE1	●	136
MER18R	●	137	MG9	●	139-241	MLE2	●	136
MER19R	●	137	MGN1R	●	131-240	MLM1	● ▲	141
MER1R	● ▲	136	MGN1RP	●	131-240	MLM15	●	141-241
MER2	● ▲ U	136	MH1	●	139-156	MLM1R	▲	141
MER20R	●	137	MH1R	●	139-156	MLM2	▲	141
MER21R	●	137	MH2	●	139-149-156	MLM3R	▲	141
MER22T	◆	137	MH2R	●	139-149-156	MLM4R	▲	141
MER23	● ▲ U	137	MH3	●	139	MLM5	■	141-241
MER24	● ▲	136	MH4	●	139-156	MLM6R	▲	141
MER25T	◆	137	MH4R	●	139-156	MLM7R	▲	141
MER26T	◆	137	MH5	●	139	MLM9	●	122-239
MER27	● ▲	136	MH5R	● ▲	139	MLN1	●	139
MER29	●	136	MI1	● ▲	142	MLN3	●	139
MER31	●	137	MI1R	● ▲	142	MN1	● ▲	141
MER32	●	137	MI2	●	142	MN2	● ▲	141
MER33R	● ▲	138	MI2R	●	142	MN2R	●	141

● Brass
Ottone
Messing
Laiton
Latón
Latão

▲ Steel
Acciaio
Stahl
Acier
Acero
Aço

■ Nickel silver
Alpaca
Neusilber
Maillechort
Alpaca
Alpaca

◆ Iron
Ferro
Eisen
Fer
Hierro
Ferro

C Available in Color
Disponibile in Color
Lieferbar in Color
Disponibile en Color
Disponibile en Color
Disponível em Color

U Available in Ultralite
Disponibile in Ultralite
Lieferbar in Ultralite
Disponibile en Ultralite
Disponibile en Ultralite
Disponível em Ultralite

S Available in Silky
Disponibile in Silky
Lieferbar in Silky
Disponibile en Silky
Disponibile en Silky
Disponível em Silky

REF.		PAGE	REF.		PAGE	REF.		PAGE
MN3	●	141	MS23	●	131-240	MTK4P	■	144-242
MN3R	●▲	141	MS24	▲	131	MTK4RP	●■	144-242
MN4	●▲	142	MS3	●▲	131	MTK4RPX	●■	144-242
MN4R	●▲	142	MS3R	●▲	131	MTK5	●▲U	143
MN5	●	142	MS4R	●▲	131	MTK5R	●▲U	143
MN5R	●▲	142	MS5R	●▲	131	MTK7R	●	144-242
MN6	●	142	MS6	●▲	131	MTK7RP	■	144-242
MN6R	●	142	MS7	●▲	131	MTK8R	●	144-242
MN7	●▲	141	MS8	●▲	131	MTK8RP	■	144-242
MN7R	●▲	141	MS9R	●▲	131	MTK9RP	●■	144-242
MN8	●▲	141	MSC1	▲	142	MTL1	●	143-241
MN8R	●▲	141	MSF1	▲	143	MTS1	▲	142
MN9	●▲	141	MSL1	●	132-240	MTS1R	▲	142
MN9R	●▲	141	MSL2	●	132-240	MTT1R	●	143
MO1RP	●	141-241	MSL3	●	132-240	MTT2R	●	143
MOD1	●▲	141	MSL4R	●	132-240	MTY1	●▲	140
MON1	●▲	141	MSL5R	●	132-240	MTY2	▲	140
MON1R	●▲	141	MST1	▲	142	MTZ1	●▲	117
MP101	●	143	MSV1	●▲	143	MU401	◆	270
MP102	●	143	MSV1R	●▲	143	MU402	◆	270
MP103	●▲	143	MSV2	▲	143	MU403	◆	270
MP104	●	143	MSV2R	▲	143	MU404	◆	270
MP105	●	143	MTA1R	▲G	138	MUL1	●U	143
MP228	●▲	143	MTA2	●	138-241	MUL2	●	143
MP229	●	143	MTA3R	▲	138	MX1	▲	138
MP230	●▲	143	MTA4	●	138-241	MX5	▲	138
MP231	●▲	143	MTK1	●■	144-241	MXU1R	▲	133
MR1	●	131	MTK10R	●	144-242	MXU2	▲	133
MS1	●▲U	131	MTK10RP	■	144-242	N		
MS10	●▲	131	MTK11	●	144-242	NAB1	●▲U	145
MS11	●▲	131	MTK11R	●U	144-242	NAB1R	●▲	145
MS11R	●▲	131	MTK12R	■	144-242	NAB2	●▲	145
MS12	●▲	131	MTK12RP	■	144-242	NAB3R	●▲	145
MS13R	●▲	131	MTK13R	●	144-242	NAB4	●▲U	145
MS14	●▲	131	MTK13RAP	●	144-242	NAB5	●	145
MS16	●	131	MTK14RP	●	144-242	NAB6	●	145
MS17	●▲	131	MTK15R	●	144-242	NCR1	●▲	145
MS19	●▲	131	MTK15RAP	●	144-242	NCR11R	●	145
MS2	●▲U	131	MTK16	■	144-242	NCR12	●	145
MS20P	●	132-240	MTK2	●	144-241	NCR13	●	145
MS21AP	●	132	MTK2P	■	144-241	NCR19	●	145
MS22	●	131-240	MTK3P	■	144-241			

● Brass
Ottone
Messing
Laiton
Latón
Latão

▲ Steel
Acciaio
Stahl
Acier
Acero
Aço

■ Nickel silver
Alpacca
Neusilber
Maillechort
Alpaca
Alpaca

◆ Iron
Ferro
Eisen
Fer
Hierro
Ferro

G Available in Color
Disponibile in Color
Lieferbar in Color
Disponibile en Color
Disponibile en Color
Disponível em Color

U Available in Ultralite
Disponibile in Ultralite
Lieferbar in Ultralite
Disponibile en Ultralite
Disponibile en Ultralite
Disponível em Ultralite

⊞ Available in Silky
Disponibile in Silky
Lieferbar in Silky
Disponibile en Silky
Disponibile en Silky
Disponível em Silky

REF.		PAGE
NCR1R	●	145
NCR2	● ▲	145
NCR3	● ▲	145
NCR4	● U	145
NCR6	● ▲	145
NEC1	▲	145
NF1	● ▲	145
NF1R	● ▲	145
NK1	●	145
NK2	●	145
NK3	●	145
NME1R	▲	146
NME2R	▲	146
NME3	▲	146
NME4R	▲	146
NN1	●	146
NP1R	● ▲	146
NR1R	▲	145
O		
OA1	● ▲	148
OA1R	● ▲	148
OA2	● ▲	148
OA2R	●	148
OA3	●	148
OA3R	● ▲	148
OAL1	● ▲	146
OAL1R	● ▲	146
OAL2	●	146
OAL2R	● ▲	146
OAL3	●	146
OAL3R	● ▲	146
OAL4	● ▲	146
OAL4R	● ▲	146
OB1	●	146
OC074	● ▲ U C S	149
OC075	●	149
OC1	●	149
OC1R	● ▲	149
OC2	● ▲	149
OC236	● ▲	149
OC237	●	149

REF.		PAGE
OC238	● ▲	149
OC239	● ▲	149
OC2R	● ▲	149
OC3	●	149-242
OC4	●	149-242
OC5	●	149
OC6	●	149-242
OF4	● ▲	147
OJ1	● ▲	147
OJ10R	▲	147
OJ11	▲	147
OJ12R	● ▲	147
OJ13R	▲	147
OJ14	■	147-242
OJ15RP	▲	147
OJ16R	▲	147
OJ17R	▲	147
OJ18	●	147-242
OJ1R	● ▲	147
OJ2	● ▲	147
OJ3R	● ▲	147
OJ4	▲	147
OJ4R	● ▲ U	147
OJ5R	● ▲	147
OJ6R	● ▲	147
OJ7R	▲	147
OJ8R	▲	147
OJ9	▲	147
OL1	●	148
OL1R	▲	148
OL2	● ▲	148
OL2R	● ▲	148
OL3	● ▲	148
OL3R	● ▲	148
OL4	● ▲	148
OL4R	● ▲	148
OL5	● ▲	148
OL5R	● ▲	148
OL6	● ▲	148
OL6R	● ▲	148
OLT1	● ▲	148
OLT2	●	148

REF.		PAGE
OLT3	●	148
OLT4	▲	148
OLT5	▲	148
OLT6R	● ▲	148
OLT7	● ▲	148
OLT8R	● ▲	148
OMR1R	● ▲	150
ON1	▲	150
ON1R	▲	150
OR1R	▲	150
ORA1	▲	150
ORA2	▲	150
ORO1	● ▲	150
ORO2	●	150
OV1	● ▲	149
OV1R	● ▲	149
OV2	▲	149
OV2R	● ▲	149
OV3	● ▲	149
OV3R	●	149
P		
PA1	●	153
PA1R	●	153
PA2	●	153
PA2R	● ▲	153
PAC1R	● U	150
PAC2R	●	150
PAC3R	●	150
PAC4	●	150
PAD1	▲	152
PAD2	▲	152
PAD3	▲	152
PC1	● ▲	153
PC10	●	153
PC10R	● ▲	153
PC11	● ▲	154
PC11R	● ▲	154
PC12T	●	154-169
PC13	▲	112-153
PC14	●	153
PC15T	●	154-169

● Brass
Ottone
Messing
Laiton
Latón
Latão

▲ Steel
Acciaio
Stahl
Acier
Acero
Aço

■ Nickel silver
Alpaca
Neusilber
Maillechort
Alpaca
Alpaca

◆ Iron
Ferro
Eisen
Fer
Hierro
Ferro

Ⓒ Available in Color
Disponibile in Color
Lieferbar in Color
Disponibile en Color
Disponibile en Color
Disponível em Color

Ⓒ Available in Ultralite
Disponibile in Ultralite
Lieferbar in Ultralite
Disponibile en Ultralite
Disponibile en Ultralite
Disponível em Ultralite

Ⓒ Available in Silky
Disponibile in Silky
Lieferbar in Silky
Disponibile en Silky
Disponibile en Silky
Disponível em Silky

Articles and materials general index / Índice Generale articoli e materiali / Allgemeines Artikel- und Materialverzeichnis / Table des matières des articles et des matériaux / Índice general de los artículos y de los materiales / Índice geral dos artigos e dos materiais

REF.		PAGE	REF.		PAGE	REF.		PAGE
PC15TP	●	154	PDO21	●	151	PF4	● ▲	157
PC18R	● ▲	153	PDO21R	●	151	PF4R	● ▲	157
PC1R	●	153	PDO22	●	151	PF5	● U	157
PC2	● ▲	153	PDO22R	●	151	PF5S	● U	157
PC20	●	153	PDO23	●	151	PF6	● ▲	157
PC26	●	153	PDO9	●	151	PF6R	● ▲	157
PC27	●	153	PDO9R	● U	151	PF7	● ▲ U	156
PC28	●	154	PF070	● ▲	157	PF7S	● ▲ U	156
PC2R	● ▲	153	PF071	● ▲	157	PF8	● ▲	156
PC3	● ▲	153	PF072	● ▲	157	PF8R	●	156
PC31R	●	153	PF073	● ▲	157	PF9	●	157
PC32R	● ▲	153	PF092	● ▲ U C S	157	PF9R	●	157
PC33	●	153	PF092S	● ▲ U C S	157	PG1	● ▲	154
PC33R	●	153	PF1	● ▲ G	157	PG1R	● ▲	154
PC3R	● ▲	153	PF11	● ▲	156	PHF10R	▲	155
PC4	●	153	PF11R	● ▲	156	PHF11R	▲	155
PC4R	●	153	PF12	● ▲	146-157	PHF12	▲	155
PC5	▲	154	PF13R	● ▲	158	PHF15	▲	155
PC5R	▲	154	PF14	▲	158	PHF16R	▲	155
PC6	● ▲	153	PF15	● ▲	157	PHF17	▲	155
PC7	●	153	PF16R	▲	157	PHF18R	● ▲	155
PC8	● ▲	153	PF18	●	158-243	PHF19	● ▲	155
PC9	● ▲	154	PF19	●	157	PHF1R	▲	155
PD1	●	158	PF1P	● ▲	157	PHF22R	▲ ■	155
PDO10R	●	151	PF1R	● ▲	157	PHF23	▲	155
PDO11	● U	151	PF1RP	●	157	PHF26	●	155
PDO12	●	151	PF2	● ▲ U C	157	PHF26R	●	155
PDO12R	●	151	PF20	●	158-243	PHF27	● ▲	155
PDO13	●	151	PF208	● ▲ U	157	PHF27R	●	155
PDO13R	●	151	PF209	● U	157	PHF28R	▲	155
PDO14	●	151	PF21	●	158-243	PHF29	▲	155
PDO14R	●	151	PF210	● ▲ U	157	PHF2R	▲	155
PDO17	●	151	PF211	● ▲ U	157	PHF32	▲	155
PDO17R	●	151	PF212	● ▲ U	157	PHF34	●	155
PDO18	● U	151	PF213	● ▲ U	157	PHF37	▲	155
PDO18R	● U	151	PF214	▲	156	PHF4R	▲	155
PDO19	●	151	PF215	●	156	PHF5	▲	155
PDO19R	●	151	PF215R	●	156	PHF6	▲	155
PDO1R	● U	151	PF22	●	158-243	PHF7R	▲	155
PDO2	● U	151	PF2S	● ▲ U	157	PHF8R	▲	155
PDO20	●	151	PF3	● ▲	156	PHF9R	▲	155
PDO20R	●	151	PF3R	● ▲	156	PIC1	● ■	155-243

● Brass
Ottone
Messing
Laiton
Latón
Latão

▲ Steel
Acciaio
Stahl
Acier
Acero
Aço

■ Nickel silver
Alpacca
Neusilber
Maillechort
Alpaca
Alpaca

◆ Iron
Ferro
Eisen
Fer
Hierro
Ferro

Ⓒ Available in Color
Disponibile in Color
Lieferbar in Color
Disponibile en Color
Disponibile en Color
Disponível em Color

Ⓢ Available in Ultralite
Disponibile in Ultralite
Lieferbar in Ultralite
Disponibile en Ultralite
Disponibile en Ultralite
Disponível em Ultralite

Ⓣ Available in Silky
Disponibile in Silky
Lieferbar in Silky
Disponibile en Silky
Disponibile en Silky
Disponível em Silky

REF.		PAGE	REF.		PAGE	REF.		PAGE
PIC2	●	155-243	RC14R	●	55-229	RIQ4R	● ▲	99
PL1	● ▲	155	RC15R	●	55-229	RIQ5	● ▲	99
PM1	●	158	RC16R	●	55-229	RIQ5R	● ▲	99
PN1	●	154-243	RC17R	●	55-229	RIQ6S	● ▲	99
PN2	●	154-243	RC1R	● ▲	54	RIQ7	● ▲	99
PRI3R	● ▲	158	RC3R	● ▲ U	54	RIQ7R	▲	99
PRL1	●	158	RC4	● ▲	54	RIQ8	● ▲	99
PS1	▲	155	RC5	● ▲	54	RIQ8R	● ▲	99
PT1	● ▲	146-149-156	RC5R	▲	54	RIQ9	▲	99
PT1R	● ▲	146-149-156	RC6	●	54	RIQ9R	▲ U	99
PT2	● ▲	156	RC6R	●	54	RL1	◆	269
PT4R	●	156-243	RC7R	▲	54	RM1A	●	160
PT5RP	●	156-243	RC8R	●	55-229	RM1RA	●	160
PT6RP	●	156-243	RC9R	●	54-229	RM2A	●	160
PT7RAP	●	156-243	RD1	●	160	RM2RA	●	160
PTZ1R	▲	155	RD2	● ▲	160	RO13	▲	161
PZ1	● ▲ U	152	RDC1	●	159	RO14	▲	161
PZ14	●	152	REL1R	● ▲	159	RO15	● ▲	161
PZ15	● U	153	REL2	●	159	RO15R	▲	161
PZ17	●	152	REL3	● ▲	159	RO20	● ▲	161
PZ18R	●	152	REN1	● ▲	159	RO20R	● ▲	161
PZ19	●	153	REN1R	● ▲	159	RO21	▲	162
PZ2	● ▲ U	152	REN2	▲	159	RO21R	▲	162
PZ20R	●	153	REN2R	▲	159	RO22	● ▲	161
PZ3	● ▲ U	152	REN3R	▲	159	RO22R	● ▲	161
PZ4	● ▲	152	REN4R	▲	159	RO23	● ▲	161
PZ5	● ▲ U	152	REN5	▲	159	RO23R	● ▲	161
PZ6	● ▲ U	152	REN6	▲	159	RO24	● ▲	161
PZ7	● U	152	REN6R	▲	159	RO24R	▲	161
PZ8	● U	152	RG1	● ▲	158	RO25	● ▲	161
PZ9	● U	152	RGA1	▲	160	RO25R	● ▲	161
R			RGM1	● ▲	160	RO26	● ▲	161
RA1	● ▲	160	RGM1R	● ▲	160	RO27	● ▲	161
RA1R	● ▲	160	RIC1	▲	160	RO27R	● ▲	161
RBT1R	●	158	RIQ1	● ▲	99	RO30	▲	161
RBT2	● U	158	RIQ10R	▲	99	RO30R	▲	161
RC10R	●	54-229	RIQ11	▲	99	RO34	▲	162
RC11	●	54-229	RIQ11R	▲	99	RO34R	▲	162
RC11R	●	54-229	RIQ1R	● ▲ U	99	RO37	▲	161
RC12R	▲	54	RIQ2	● ▲	99	RO37R	● ▲	161
RC13R	▲	54	RIQ3	▲	99	RO38	● ▲	161
			RIQ4	● ▲	99	RO38R	▲	161

● Brass
Ottone
Messing
Laiton
Latón
Latão

▲ Steel
Acciaio
Stahl
Acier
Acero
Aço

■ Nickel silver
Alpaca
Neusilber
Maillechort
Alpaca
Alpaca

◆ Iron
Ferro
Eisen
Fer
Hierro
Ferro

Ⓒ Available in Color
Disponibile in Color
Lieferbar in Color
Disponibile en Color
Disponibile en Color
Disponível em Color

Ⓒ Available in Ultralite
Disponibile in Ultralite
Lieferbar in Ultralite
Disponibile en Ultralite
Disponibile en Ultralite
Disponível em Ultralite

Ⓒ Available in Silky
Disponibile in Silky
Lieferbar in Silky
Disponibile en Silky
Disponibile en Silky
Disponível em Silky

REF.		PAGE	REF.		PAGE	REF.		PAGE
RO4	●▲U	161	RU1R	●▲	162	S		
RO41	●▲UCS	161-199	RU2	▲	162			
RO42	●▲	161	RU20	●	162	SA1	▲	163
RO42R	●▲	161	RU21	●	162	SA1R	▲	163
RO43R	●▲	161	RU22R	●	162	SA2	▲	163
RO44	▲	162	RU23R	●	162	SA2R	●▲	163
RO44R	▲	162	RU24R	●	162	SA3	▲	163
RO45	●▲	161	RU25	●	162	SA3R	▲	163
RO46R	●▲	161	RU25R	●	162	SA4	▲	163
RO47	▲	161	RU26	●	162	SA5	▲	163
RO47R	▲	161	RU27	●	162	SA5R	▲	163
RO48R	●▲	161	RU28	▲	162	SAM1	●U	174
RO49	▲	162	RU29R	▲	162	SAM10	●	175
RO4R	●▲	161	RU2R	▲	162	SAM11R	●	175
RO50	▲	161	RU3	●▲	162	SAM12R	●	175
RO51	▲	162	RU30	▲	162	SAM13	●	174
RO53R	▲	162	RU3R	●▲	162	SAM13R	●	174
RO67	●	161	RU4	●▲	162	SAM14	●	174
RO67R	●	161	RU4R	●▲	162	SAM15R	●	174
RO68	●	161	RU5	▲	162	SAM16R	●	175
RO68R	●	161	RU5R	▲	162	SAM1R	●U	174
RO69	▲	161	RU6	▲	162	SAM2	●U	175
RO7	●▲	161	RU7	●▲	162	SAM2R	●U	175
RO77	▲	161	RU8R	●▲	162	SAM3R	●U	175
RO7R	●▲	161	RU9R	●▲	162	SAM4	●	174
RO8	●▲UCS	161	RUS1	▲	114	SAM6	●	175
RO84	▲	162	RUS1R	▲	114	SAM8	●	175
RO85	▲	161	RUS2	▲	114	SAM9R	●	174
RO8R	●▲	161	RUS3R	▲	67	SAN1	●▲	164
RO9	●▲	161	RUS4	▲	163	SAN1R	●▲	164
RO9R	▲	161	RUS5	▲	163	SAR1	▲■	165
ROY1	▲	162	RUS6	▲	163	SAR1031	●	269
RSS3	●	162-244	RV1	●	160	SAR1032	●	269
RU1	●▲UC	162	RW25	●▲	163	SAR17	▲	164
RU10R	●▲	162	RW7R	●	163	SAR17R	●▲	164
RU11R	●▲	162	RW8R	●	163	SAR2	●▲■	165
RU12	●▲	162	RX1	●▲	160	SAR21	●	164
RU13	▲	162	RX2	●▲	160	SAR21R	▲	164
RU14	●▲UC	162	RZA1	▲	160	SAR22R	▲	164
RU15R	▲	162	RZA2	▲	160	SAR3	●U	164
RU16	▲	162	RZA3	▲	160	SAR3R	●▲U	164
RU19	▲	162				SAR4R	▲	165

● Brass
Ottone
Messing
Laiton
Latón
Latão

▲ Steel
Acciaio
Stahl
Acier
Acero
Aço

■ Nickel silver
Alpacca
Neusilber
Maillechort
Alpaca
Alpaca

◆ Iron
Ferro
Eisen
Fer
Hierro
Ferro

Ⓒ Available in Color
Disponibile in Color
Lieferbar in Color
Disponibile en Color
Disponibile en Color
Disponível em Color

Ⓘ Available in Ultralite
Disponibile in Ultralite
Lieferbar in Ultralite
Disponibile en Ultralite
Disponibile en Ultralite
Disponível em Ultralite

Ⓔ Available in Silky
Disponibile in Silky
Lieferbar in Silky
Disponibile en Silky
Disponibile en Silky
Disponível em Silky

REF.		PAGE	REF.		PAGE	REF.		PAGE
SAR8	●	164	SGM1	▲	169	SJ1R	▲	171
SB1	● ▲	163	SH1	● ◆	165	SKR1	▲	167
SC1	▲	167	SH10	● ▲ ■	166	SL1	● ▲ U	167
SC2	● ▲	167	SH11	● ▲ ■	166	SLC1TP	●	154-169
SCH1R	●	163-244	SH12	▲	166	SLC2TP	●	154-169
SCM1R	●	167-244	SH12R	●	165	SLC3T	●	169
SCM2	●	167-244	SH13	●	166	SLR1	▲	172
SCM3RP	●	167-244	SH14	● ▲	166	SLX1	●	172
SCM4	●	167	SH15	▲	166	SM1	● ▲ U G	38-96-170
SCT1R	●	167-244	SH16	● ▲ U	166	SM10R	▲	170
SCU1	Zama	167-244	SH17	●	166	SM11	▲	170
SD1	● ▲	169	SH18	●	166	SM12	▲	170
SD2	▲	169	SH19	●	166	SM13	▲	170
SD3T	●	169	SH2	● ◆	165	SM14R	▲	170
SDT1R	●	178-245	SH20	● U	166	SM15	▲	170
SE1	▲	168	SH21	●	166	SM16	● ▲	170
SE1R	▲	168	SH22	● ▲	166	SM1R	● ▲ U	96-170
SE3	▲	168	SH23	● ▲ ■	166	SM2	● ▲	170
SE3R	▲	168	SH24	●	166	SM3	● ▲	170
SE5	● ▲	168	SH27	● ▲	165	SM4	● ▲	170
SE5R	● ▲	168	SH3	● ▲ ■ U	166	SM5	● ▲	170
SE7	▲	168	SH4	● ▲ U	166	SM6	▲	170
SE7R	● ▲	168	SH5	● ▲ ■ U	166	SM8	● ▲	170
SE8	▲	168	SH5R	▲	165	SM9	▲	170
SEA4	●	139-167	SH6	▲ ■	166	SM9R	▲	170
SEA4R	●	139-167	SH7	● ■ U	166	SMA1	▲	163
SEA5	● ▲	150-167	SH8	● ▲	166	SN1	▲	172
SEA5R	● ▲	150-167	SH9	● ▲	166	SN1R	● ▲	172
SEA7	● ▲	150-167	SHT1	▲	168	SN2	● ▲	172
SEA8	● ▲	150-167	SHW1	▲	168	SN2R	● ▲ U	172
SEB1	● ■	166-244	SHW2	● ▲	168	SN3R	● ▲	171
SEB2	■	166-244	SI1	● ▲	172	SN4R	▲	171
SEB3	■	166-244	SI1R	▲ U	172	SN5R	● ▲	172
SEI10	●	3	SI2R	● ▲	172	SNC1	▲	172
SEM1	▲	168	SI3R	● ▲	172	SNC2	▲	172
SF1	● ◆	163	SI4	▲	172	SNC2R	▲	172
SF2	●	163	SI4R	● ▲ U	172	SNC3	▲	172
SFB1R	●	168	SI5R	▲	172	SNW1	●	164
SFD1R	▲	175	SI6R	● ▲	172	SNW2	●	164
SG1	▲	54-168	SIA1R	▲	169	SNW3	●	164
SG808	● ▲ U	54-168	SIL1	▲	169	SO10R	▲	174
SG808R	● ▲	54-168	SIL1R	▲	169	SO11R	▲	174

● Brass
Ottone
Messing
Laiton
Latón
Latão

▲ Steel
Acciaio
Stahl
Acier
Acero
Aço

■ Nickel silver
Alpacca
Neusilber
Maillechort
Alpaca
Alpaca

◆ Iron
Ferro
Eisen
Fer
Hierro
Ferro

Ⓒ Available in Color
Disponibile in Color
Lieferbar in Color
Disponibile en Color
Disponível em Color

Ⓢ Available in Ultralite
Disponibile in Ultralite
Lieferbar in Ultralite
Disponibile en Ultralite
Disponível em Ultralite

Ⓣ Available in Silky
Disponibile in Silky
Lieferbar in Silky
Disponibile en Silky
Disponível em Silky

REF.		PAGE	REF.		PAGE	REF.		PAGE
SO4	▲	173	SS13	●▲U	171	STL1R	▲	176
SO5	▲	173	SS14	▲	170	STL2R	▲	176
SO6	▲	173	SS14R	▲	170	STL3	▲	176
SO7	▲	173	SS1R	●▲	170	STN1	●▲	177
SO8R	▲	173	SS3	●▲	170	STN1R	●▲	177
SO9	▲	173	SS3R	●▲	170	STR3	▲	176
SOF1	●▲	172	SS4	●▲	171	STR4	●▲	176
SOF1R	●▲	172	SS6	●▲	170	STR4R	●▲	176
SOP1	●U	173	SS7	●▲	170	STR5	▲	176
SOP10	●	173	SS7R	●▲	170	STR5R	●▲	176
SOP11	●	173	SS8	●▲	171	STR6	●▲	176
SOP12	●	173	SS9	●▲U	170	STS1	▲	177
SOP13R	●	173	SSO1	▲	171	STS11	▲	177
SOP14RP	●	173	SSO2	▲	171	STS12	■	177-245
SOP15R	●	173	SSP1	▲	171	STS13	●	177-245
SOP16R	●	173	SSP1R	●▲	171	STS1R	▲	177
SOP17R	●	173	SSP2	●▲	171	STS2	▲	177
SOP18R	●	173	SSP4	▲	171	STS2R	▲	177
SOP2	●	173	SSP4R	▲	171	STS3	▲	177
SPR1	■	174-245	SSP5	●▲	171	STS4	▲	177
SPR2	●■	174-245	SSP6	▲	171	STS5	●	177-245
SPU1R	●	178	ST1	●▲	166	STS6	●▲S	177-245
SQ1	●▲	174	STA1	▲	175	STS9	●■	177-245
SQ2	▲	174	STA10	●	175	STU1	▲U	165
SQ3R	▲	174	STA10R	●▲	175	STU3	▲	165
SQ4R	▲	174	STA11R	▲	176	STU6R	●	165-244
SQ5	▲	174	STA1R	▲	175	STY1P	▲	176
SQ6R	▲	174	STA2	●▲	175	SU1R	●▲	178
SR10R	●▲	178	STA2R	●▲	175	SV1	●▲	178
SR11R	●▲	178	STA3	●▲	175	SV1R	●▲	178
SR2	▲	178	STA3R	●▲	175	SV2	▲	178
SR2R	▲	178	STA4	●▲U	176	SV2R	▲	178
SR4	▲	178	STA4R	●▲U	176	SV3	▲	177
SR6	▲	178	STA5	●▲	176	SV3R	▲	177
SR7	▲	178	STA6	●▲	176	SV4	●▲	178
SR8	▲	178	STA6R	●▲	176	SV4R	●▲	178
SR9R	▲	178	STA7	▲	176	SV5	▲	178
SRT1	▲	164	STA8	▲	176	SV5R	●▲	178
SRT2	▲	164	STA8R	▲	176	SV6R	●▲	178
SS1	●	170	STA9R	▲	175	SV7	●▲	177
SS10	●▲U	170	STF1	●▲	177	SV8	▲	178
SS12	▲	170	STF1R	●▲	177	SV8R	▲	178

● Brass
Ottone
Messing
Laiton
Latón
Latão

▲ Steel
Acciaio
Stahl
Acier
Acero
Aço

■ Nickel silver
Alpacca
Neusilber
Maillechort
Alpaca
Alpaca

◆ Iron
Ferro
Eisen
Fer
Hierro
Ferro

Ⓒ Available in Color
Disponibile in Color
Lieferbar in Color
Disponibile en Color
Disponibile en Color
Disponível em Color

Ⓘ Available in Ultralite
Disponibile in Ultralite
Lieferbar in Ultralite
Disponibile en Ultralite
Disponibile en Ultralite
Disponível em Ultralite

Ⓔ Available in Silky
Disponibile in Silky
Lieferbar in Silky
Disponibile en Silky
Disponibile en Silky
Disponível em Silky

REF.		PAGE	REF.		PAGE	REF.		PAGE
SVE1R	▲	165	TAR7	▲	180	TL1	●▲U	189
SVE2R	▲	165	TAR7R	▲	180	TL10	●▲	190
SVN1	●▲	169	TAR8	●▲	180	TL10R	●▲	190
SVN2	●	169	TAR8R	●▲	180	TL11	●▲U	190
SW1R	●▲	179	TAR9	●▲	179	TL11R	●▲U	190
SW2	●	179	TAR9R	●▲	179	TL12	▲	190
SW3	●▲	179	TC1	●	182	TL12R	▲	190
SWA1	●▲	169	TC1R	●▲	182	TL13	●▲	190
SWA10	●	168	TCL1	▲	181	TL14	●▲	190
SWA13R	■	168	TE1	●▲U	181	TL15	▲	190
SWA2R	●▲	169	TE16	●	181-246	TL15R	▲	190
SWA3R	●▲	169	TE19	●	181-246	TL16R	▲	189
SWA4R	●	169	TE1R	▲	181	TL1R	●▲U	189
SWA5R	●	169	TE2	●▲U☉☼	181	TL2	●▲U	189
SWA6R	●	169	TE2R	●▲	181	TL2R	●▲U	189
SWA7R	●▲	169	TE2X	●▲U	181	TL3	●▲U	189
SWA8	●▲U	169	TE3	●▲U	181	TL3R	●▲U	189
SWA9R	●▲	169	TE4	●■	181-246	TL4	●▲U	189
SWL1	●▲	176	TE4R	●■	181-246	TL4R	●▲U	189
SY1	●	171	TE5	●■	181-246	TL5	●▲	189
T			TE6	▲	181	TL5R	●▲	189
TAR1	●▲	180	TE7	●■U☉☼	182-246	TL6	●▲	189
TAR10	●	180	TE8XFA	▲	181	TL6R	●▲	189
TAR10R	●▲	180	TE9	●	182-246	TL7	●▲	189
TAR11	●	179	TEC1	■	180-245	TL7R	●▲	189
TAR11R	●▲	179	TEN1	●	180-245	TL8	●▲U	189
TAR16	●	179-245	TEN2R	▲	180	TL8R	●▲U	189
TAR16R	●	179-245	TFN1	▲	182	TL9	●▲	190
TAR1R	●▲	180	TFN2	▲	182	TL9R	●▲	190
TAR2	▲	180	TG1	●▲	182	TLC1R	●	182-246
TAR21	●	179-245	TGS1R	●	181-245	TLN1	▲	179
TAR26	●	179	THA1	▲	182	TM1RP	●	190-247
TAR2R	●▲	180	THR1	●	182-246	TN1	▲	182
TAR3	●▲	180	TI1	●	182	TN10	▲	183
TAR3R	●▲	180	TK1	●▲■	181	TN11R	▲	183
TAR4	●▲	179	TK1R	●▲	181	TN14	▲	183
TAR4R	●▲	179	TK2	●▲	181	TN16	▲	183
TAR5	●▲	179	TK2R	●▲■	181	TN16X	▲U	183
TAR5R	●▲	179	TK3	●▲	181	TN16XA	▲U	183
TAR6	▲	180	TK3R	●▲	181	TN19R	▲	183
TAR6R	▲	180	TK4	●▲	181	TN1R	●▲	182
			TK4R	●▲	181	TN2	▲U☉☼	182

● Brass
Ottone
Messing
Laiton
Latón
Latão

▲ Steel
Acciaio
Stahl
Acier
Acero
Aço

■ Nickel silver
Alpacca
Neusilber
Maillechort
Alpaca
Alpaca

◆ Iron
Ferro
Eisen
Fer
Hierro
Ferro

☉ Available in Color
Disponibile in Color
Lieferbar in Color
Disponibile en Color
Disponibile en Color
Disponível em Color

U Available in Ultralite
Disponibile in Ultralite
Lieferbar in Ultralite
Disponibile en Ultralite
Disponibile en Ultralite
Disponível em Ultralite

☼ Available in Silky
Disponibile in Silky
Lieferbar in Silky
Disponibile en Silky
Disponibile en Silky
Disponível em Silky

REF.		PAGE	REF.		PAGE	REF.		PAGE
TN20	▲	183	TO19	●■	187	TO50RX6	●▲	185
TN20R	▲	183	TO1X	●▲Uⓐⓑ	186	TO50RX7	●▲	185
TN23	▲	183	TO2	●	186	TO50RX9	●	185
TN2R	▲	182	TO20R	●■	187	TO50X1	●	185
TN31R	●	183	TO21	●▲■	187	TO50X10	●	185
TN32	●	183-246	TO22	●▲	184	TO50X11	●	185
TN35	▲	183	TO23	●	184	TO50X12	●	185
TN36	▲	183	TO24	▲	184	TO50X13	▲	185
TN36R	▲	183	TO25R	●▲	186	TO50X14	●	185
TN37R	▲	182	TO26	●▲	184	TO50X15	▲	185
TN39	●▲	183	TO27	●▲	187	TO50X16	●	185
TN4	●▲	183	TO28R	●▲	186	TO50X17	▲	185
TN4R	●▲	183	TO29	●▲U	184	TO50X18	●	185
TN5	●▲U	182	TO29X	●▲	186	TO50X2	●▲	185
TN50	●	183	TO3	●	186	TO50X3	●	185
TN51	●	183-246	TO30	▲	187	TO50X4	●▲	185
TN6R	●▲	183	TO30R	●▲ⓐ	187	TO50X5	●▲	185
TN7	▲U	183	TO30RX	●▲ⓐ	187	TO50X6	●▲	185
TN8R	●▲	182	TO30X	▲	187	TO50X7	●▲	185
TN9	▲	183	TO31R	●▲	186	TO50X8	●	185
TO1	●▲U	186	TO33	●▲	187	TO50X9	●▲	185
TO10	●▲	186	TO34	●▲	187	TO51RY1	▲	186
TO100	●	187	TO35	▲	186	TO51RY10	●	186
TO104	▲	187	TO36R	●	186	TO51RY11	●	186
TO105	▲	187	TO39R	▲	187	TO51RY12	●	186
TO106	▲	187	TO4	●▲	186	TO51RY13	●	186
TO107	▲	187	TO40	●▲	187	TO51RY14	●	186
TO108X	▲	187	TO41R	▲	186	TO51RY15	●	186
TO11	●	187	TO42R	●■	187	TO51RY16	●	186
TO111R	●	187	TO43	●	187	TO51RY17	●	186
TO114RX	●▲	186	TO44	▲	184	TO51RY18	●	186
TO12	●▲	184	TO45	■	187	TO51RY2	●	186
TO120RX	●▲	186	TO5	●▲	186	TO51RY3	●	186
TO124RX	▲	186	TO50RX13	●	185	TO51RY4	●	186
TO125X	▲	186	TO50RX14	●	185	TO51RY5	●	186
TO127	▲	187	TO50RX15	●	185	TO51RY6	●	186
TO13	●▲	187	TO50RX16	●	185	TO51RY7	●	186
TO14	●▲	187	TO50RX17	●	185	TO51RY8	●	186
TO15	●	186	TO50RX18	●	185	TO51RY9	●	186
TO16	●▲	186	TO50RX2	●▲	185	TO51Y1	●▲	186
TO17	●▲	186	TO50RX4	●▲	185	TO51Y10	●	186
TO18	●■	187	TO50RX5	▲	185	TO51Y11	●	186

● Brass
Ottone
Messing
Laiton
Latón
Latão

▲ Steel
Acciaio
Stahl
Acier
Acero
Aço

■ Nickel silver
Alpacca
Neusilber
Maillechort
Alpaca
Alpaca

◆ Iron
Ferro
Eisen
Fer
Hierro
Ferro

ⓐ Available in Color
Disponibile in Color
Lieferbar in Color
Disponibile en Color
Disponibile en Color
Disponível em Color

ⓑ Available in Ultralite
Disponibile in Ultralite
Lieferbar in Ultralite
Disponibile en Ultralite
Disponibile en Ultralite
Disponível em Ultralite

ⓒ Available in Silky
Disponibile in Silky
Lieferbar in Silky
Disponibile en Silky
Disponibile en Silky
Disponível em Silky

REF.		PAGE	REF.		PAGE	REF.		PAGE
TO51Y12	●	186	TO64	■	187	TO8X9	●	185
TO51Y13	●	186	TO65	■	187	TO91	●	187
TO51Y14	●	186	TO66	▲	184	TO92R	●	184
TO51Y15	●	186	TO7	● ▲	186	TO9RY1	● ▲	185
TO51Y16	●	186	TO75R	● ▲	186	TO9RY10	● ▲	185
TO51Y17	●	186	TO81R	▲	187	TO9RY11	● ▲	185
TO51Y18	● ▲	186	TO82R	● ▲	186	TO9RY12	● ▲	185
TO51Y2	●	186	TO8RX1	● ▲	185	TO9RY13	● ▲	185
TO51Y3	●	186	TO8RX10	●	185	TO9RY14	● ▲	185
TO51Y4	●	186	TO8RX11	●	185	TO9RY15	● ▲	185
TO51Y5	● ▲	186	TO8RX12	●	185	TO9RY16	● ▲	185
TO51Y6	● ▲	186	TO8RX13	●	185	TO9RY17	● ▲	185
TO51Y7	●	186	TO8RX14	● ▲	185	TO9RY18	● ▲	185
TO51Y8	●	186	TO8RX15	● ▲	185	TO9RY2	● ▲	185
TO51Y9	▲	186	TO8RX16	● ▲	185	TO9RY3	● ▲	185
TO52	▲ ■	187	TO8RX17	● ▲	185	TO9RY4	● ▲	185
TO53	●	187	TO8RX18	● ▲	185	TO9RY5	● ▲	185
TO54-1	●	186	TO8RX2	●	185	TO9RY6	● ▲	185
TO54-13	●	186	TO8RX3	● ▲	185	TO9RY7	● ▲	185
TO54-14	●	186	TO8RX4	● ▲	185	TO9RY8	● ▲	185
TO54-16	●	186	TO8RX5	●	185	TO9RY9	● ▲	185
TO54-17	●	186	TO8RX6	●	185	TO9Y1	● ▲	185
TO54-18	●	186	TO8RX7	● ▲	185	TO9Y10	●	185
TO54-19	●	186	TO8RX8	● ▲	185	TO9Y11	● ▲	185
TO54-2	●	186	TO8RX9	● ▲	185	TO9Y12	● ▲	185
TO54-20	●	186	TO8X1	● ▲	185	TO9Y13	● ▲	185
TO54-21	●	186	TO8X10	●	185	TO9Y14	● ▲	185
TO54-23	●	186	TO8X11	● ▲	185	TO9Y15	● ▲	185
TO54-24	●	186	TO8X12	●	185	TO9Y16	● ▲	185
TO54-3	●	186	TO8X13	● ▲	185	TO9Y17	● ▲	185
TO54-4	●	186	TO8X14	● ▲	185	TO9Y18	● ▲	185
TO54-5	●	186	TO8X15	● ▲	185	TO9Y2	● ▲	185
TO54-6	●	186	TO8X16	● ▲	185	TO9Y3	● ▲	185
TO54-7	●	186	TO8X17	● ▲	185	TO9Y4	●	185
TO54-8	●	186	TO8X18	● ▲	185	TO9Y5	● ▲	185
TO55	■	187	TO8X2	● ▲	185	TO9Y6	●	185
TO57	● ▲ ■	187	TO8X3	● ▲	185	TO9Y7	● ▲	185
TO58	●	187	TO8X4	● ▲	185	TO9Y8	● ▲	185
TO59	■	187	TO8X5	● ▲	185	TO9Y9	● ▲	185
TO6	● ▲	186	TO8X6	●	185	TOL1	▲	191
TO60	■	187	TO8X7	● ▲	185	TOL2	▲	191
TO61	■	187	TO8X8	● ▲	185	TOP1R	● ▲	6-187

● Brass
Ottone
Messing
Laiton
Latón
Latão

▲ Steel
Acciaio
Stahl
Acier
Acero
Aço

■ Nickel silver
Alpacca
Neusilber
Maillechort
Alpaca
Alpaca

◆ Iron
Ferro
Eisen
Fer
Hierro
Ferro

Ⓒ Available in Color
Disponibile in Color
Lieferbar in Color
Disponibile en Color
Disponibile en Color
Disponível em Color

Ⓒ Available in Ultralite
Disponibile in Ultralite
Lieferbar in Ultralite
Disponibile en Ultralite
Disponibile en Ultralite
Disponível em Ultralite

Ⓒ Available in Silky
Disponibile in Silky
Lieferbar in Silky
Disponibile en Silky
Disponibile en Silky
Disponível em Silky

REF.		PAGE	REF.		PAGE	REF.		PAGE
TOP1RX	▲ U S	187	TRF6R	●	3	U		
TOU1R	●	187	TRK10	▲	188	UAP1	▲	191
TOU2R	● ▲	187	TRK10R	▲	188	UAP2	▲	191
TOU3R	●	187	TRK11DP	■	189	UB1R	● ▲	197
TOZ13	▲	184	TRK13EP	●	189	UB2R	● ▲ U	197
TOZ14	▲	184	TRK1P	●	189	UB3	● ■	197-247
TOZ2	▲	184	TRK4CP	●	188	UB5	●	197
TOZ6	▲	184	TRK5P	●	189	UC1	▲	192
TP1	● ▲	31-179	TRK6EP	●	189	UC1R	▲ U	192
TP1R	● ▲	179	TRK6P	●	189	UC2	▲	192
TP2	● ▲	179	TRK7P	● ▲	189	UC3RP	● ■	192-247
TP2R	● ▲	179	TRK8DP	■	189	UC4R	●	192-247
TP3	▲	179	TRK9	▲	188	UC5R	●	192-247
TP3R	▲	179	TRK9R	▲	188	UC6R	▲ U	192
TR1	● ■	190	TRM1R	●	3-225	UC8R	● S	192-247
TR10	●	190	TRM2	▲	3	UE2R	●	192
TR10R	●	190	TRM3	▲	3	UE3R	● U	192
TR11R	●	190	TRS1R	▲	191	UE4R	● U	192
TR12	●	190	TRU1R	●	188	UE5R	●	192
TR13R	●	190	TS1	▲	188	UL046	● ▲ U	194
TR14	●	191	TS2	▲	188	UL047	▲ U	194
TR15	●	191	TS3	▲	188	UL048	● ▲ U	195
TR16	▲	190	TS4	▲	188	UL049	● ▲ U	195
TR17R	● ▲	190	TS5	▲	188	UL050	● ▲ U C S	194
TR18R	● ▲	190	TTL1	●	183	UL050B	● ▲	195
TR19R	● ▲	190	TTL2	●	184	UL050C	● ▲ U	195
TR2	● ▲	190	TU1	▲	191	UL050D	● ▲ U	195
TR3	● ▲	190	TU2	▲	191	UL050DC	● ▲	195
TR4	● ▲ ■ U	190	TUS1	▲	180	UL050E	● ▲ U	195
TR5	● ▲	190	TUS1R	▲	180	UL050F	● ▲ U	196
TR8	●	190	TUS2R	▲	180	UL050G	● ▲ U	196
TR9	●	190	TV1	●	188-246	UL050H	● ▲ U	196
TRE1	● U	3	TV2	● ■	188-246	UL050L	● ▲ U	196
TRE2	● U	3	TV3	● ■	188-246	UL050M	● ▲ U	197
TRE3	●	3	TV4	●	188-246	UL050SL	● ▲ C	196
TRF1	●	3	TW1	● ▲	191	UL050X	● ▲ U C S	197
TRF1R	●	3	TY1	● ▲	180	UL050XL	● ▲	196
TRF2	●	3	TZ1	● ▲	191	UL050Y	● ▲ U	197
TRF3	●	3	TZ2	● ▲	191	UL051	● ▲ U C S	194
TRF3R	●	3	TZ2R	● ▲	191	UL051B	● ▲	195
TRF4	●	3	TZN1	● ▲	180	UL051C	● ▲ U	195
TRF5R	●	3						

● Brass
Ottone
Messing
Laiton
Latón
Latão

▲ Steel
Acciaio
Stahl
Acier
Acero
Aço

■ Nickel silver
Alpacca
Neusilber
Maillechort
Alpaca
Alpaca

◆ Iron
Ferro
Eisen
Fer
Hierro
Ferro

Ⓒ Available in Color
Disponibile in Color
Lieferbar in Color
Disponibile en Color
Disponibile en Color
Disponível em Color

Ⓘ Available in Ultralite
Disponibile in Ultralite
Lieferbar in Ultralite
Disponibile en Ultralite
Disponibile en Ultralite
Disponível em Ultralite

Ⓔ Available in Silky
Disponibile in Silky
Lieferbar in Silky
Disponibile en Silky
Disponibile en Silky
Disponível em Silky

REF.		PAGE	REF.		PAGE	REF.		PAGE
UL051D	●▲U	195	UL057	●▲U	194	UNI36R	●▲	193
UL051DC	▲	197	UL058	●▲UCS	194	UNI37	●▲	193
UL051E	●▲U	195	UL058A	●▲U	195	UNI37R	●▲	193
UL051F	●▲U	196	UL058SL	●▲C	197	UNI38	●▲	193
UL051G	●▲U	196	UL059	●▲UCS	194	UNI38R	●▲	193
UL051L	●▲U	196	UL059A	●▲U	195	UNI39	●▲	193
UL051M	●▲U	197	UL060	●▲U	194	UNI39R	●▲	193
UL051SL	●▲C	196	UL061	●▲U	194	UNI3S	▲U	193
UL051X	●▲U	197	UL062	▲	195	UNI4	▲	194
UL051XL	●▲	196	UL063	▲	195	UNI40	●▲	193
UL051Y	●▲U	197	UL064	▲	194	UNI40R	●▲	193
UL052	●▲UCS	195	UL064L	▲	196	UNI41	●▲	193
UL052B	●▲	195	ULS1R	▲	192	UNI41R	●▲	193
UL052C	●▲U	195	UM1	●▲	192	UNI44	●▲	193
UL052D	●▲U	195	UM1R	●▲	192	UNI44R	●▲	193
UL052E	●▲U	195	UM2	●▲	192	UNI45	●▲	193
UL052F	●▲	196	UNI1010	◆	269	UNI45R	●▲	193
UL052G	●▲U	196	UNI11	▲	193	UNI46	●	193
UL052H	●U	196	UNI12	●▲	158-194	UNI46R	●▲	193
UL052L	●▲U	197	UNI14	●▲	193	UNI47	●▲	193
UL052M	●▲U	197	UNI15	●▲	194	UNI47R	●▲	193
UL052SL	●▲C	197	UNI16	●▲	193	UNI48	●▲	193
UL052XL	●▲	197	UNI16R	●▲	193	UNI48R	●▲	193
UL053	●▲UCS	195	UNI18	▲	193	UNI49	●▲	193
UL053B	●▲	195	UNI22	●▲	194	UNI49R	●▲	193
UL053C	●▲U	195	UNI23	▲	194	UNI4R	▲	194
UL053D	●▲U	195	UNI27	●▲	194	UNI5	▲	194
UL053E	●▲U	195	UNI28	●▲	193	UNI50	●	193
UL053G	●▲U	196	UNI29	●▲	194	UNI50R	●▲	193
UL053L	●▲U	197	UNI3	●▲UC	193	UNI51	●	193
UL053M	●▲U	197	UNI30	●▲	194	UNI51R	●▲	193
UL053SL	●▲C	197	UNI31	●▲	193	UNI52	●▲	193
UL053XL	●	197	UNI31R	▲	193	UNI52R	●▲	193
UL054	●▲UCS	194	UNI32	●▲U	193	UNI54R	●▲	193
UL054L	●▲U	196	UNI32R	●▲U	193	UNI56R	●▲	194
UL054SL	●▲C	196	UNI33	●▲	193	UNI57R	▲	194
UL054XL	▲	196	UNI33R	●▲	193	UNI58R	▲	194
UL055	●▲U	194	UNI34	●▲	193	UNI59R	▲	194
UL055L	●▲U	196	UNI34R	●▲	193	UNI6	●▲	193
UL055SL	●▲C	196	UNI35	●▲	193	UNI60R	▲	194
UL055XL	▲	196	UNI35R	●▲	193	UNI61	●▲	194
UL056	●▲U	194	UNI36	●▲	193	UNI61R	▲	194

● Brass
Ottone
Messing
Laiton
Latón
Latão

▲ Steel
Acciaio
Stahl
Acier
Acero
Aço

■ Nickel silver
Alpaca
Neusilber
Maillechort
Alpaca
Alpaca

◆ Iron
Ferro
Eisen
Fer
Hierro
Ferro

C Available in Color
Disponibile in Color
Lieferbar in Color
Disponibile en Color
Disponibile en Color
Disponível em Color

U Available in Ultralite
Disponibile in Ultralite
Lieferbar in Ultralite
Disponibile en Ultralite
Disponibile en Ultralite
Disponível em Ultralite

S Available in Silky
Disponibile in Silky
Lieferbar in Silky
Disponibile en Silky
Disponibile en Silky
Disponível em Silky

REF.		PAGE	REF.		PAGE	REF.		PAGE
UNI63	▲	194	VAC124	▲	202	VAC1R	▲	198
UNI66R	●	193	VAC125	▲	202	VAC2	●▲UCS	199
UNI67R	●	193	VAC126	▲	202	VAC20	●▲	200
UNI68R	▲	193	VAC127	▲	202	VAC20N	▲	200
UNI7	▲	193	VAC128	▲	202	VAC20R	●▲	200
UP1	▲	197	VAC129	▲	202	VAC20RN	●▲	200
UR1	●▲	198	VAC130	▲	202	VAC21	●▲	200
UR1R	●▲	198	VAC131	▲	202	VAC21N	▲	200
UR2	▲	198	VAC132	▲	202	VAC21R	●▲	200
UR2R	▲	198	VAC133	▲	202	VAC21RN	●▲	200
V			VAC134	▲	202	VAC22	●▲	200
VAC1	●▲	198	VAC135	▲	202	VAC22N	▲	200
VAC10	●▲	198	VAC136	▲	202	VAC22R	●▲	200
VAC100	●▲	198	VAC137	▲	202	VAC22RN	●▲	200
VAC100R	▲	198	VAC138	▲	202	VAC23	●▲	200
VAC101	▲	202	VAC139	▲	202	VAC23R	●▲	200
VAC103	■	202-247	VAC14	▲	199	VAC25	▲U	198
VAC104	■	202-247	VAC140	▲	202	VAC25R	●▲	198
VAC105	■	202-247	VAC141	▲	202	VAC29	▲G	199
VAC106	▲	198	VAC142	▲	202	VAC3	●▲UC	199
VAC106R	▲	198	VAC143	▲	202	VAC30	●▲	199
VAC107	▲	198	VAC144	▲	202	VAC30R	●▲	199
VAC107R	▲	198	VAC145	▲	202	VAC31	●▲	200
VAC108	▲	202	VAC146	▲	202	VAC31R	▲	200
VAC109	▲	202	VAC147	▲	202	VAC32	▲	200
VAC11	●▲	198	VAC148	▲	202	VAC33	▲	198
VAC110	▲	202	VAC15	●▲	200	VAC33R	●▲	198
VAC111	▲	202	VAC150	●	202-247	VAC34	●▲	200
VAC112	▲	202	VAC151	●▲UCS	202	VAC34R	▲	200
VAC113	▲	202	VAC152	■	203-247	VAC36	▲	200
VAC114	▲	202	VAC153R	■	203-247	VAC36R	●▲	200
VAC115	▲	202	VAC15R	●▲	200	VAC37	▲	200
VAC116	▲	202	VAC16	●▲	200	VAC37R	●▲	200
VAC117	▲	202	VAC16R	●▲	200	VAC38	●▲	200
VAC118	▲	202	VAC17	●▲	200	VAC38R	●▲	200
VAC119	▲	202	VAC17R	●▲	200	VAC39	▲	201
VAC11R	●▲	198	VAC18	●▲	200	VAC4	▲	199
VAC120	▲	202	VAC18R	●▲	200	VAC40	▲	200
VAC121	▲	202	VAC19	●▲	200	VAC40R	●▲	200
VAC122	▲	202	VAC19N	▲	200	VAC41	●▲	198
VAC123	▲	202	VAC19R	●▲	200	VAC42	▲	198
			VAC19RN	●▲	200	VAC42R	●▲	198

● Brass
Ottone
Messing
Laiton
Latón
Latão

▲ Steel
Acciaio
Stahl
Acier
Acero
Aço

■ Nickel silver
Alpacca
Neusilber
Maillechort
Alpaca
Alpaca

◆ Iron
Ferro
Eisen
Fer
Hierro
Ferro

Ⓒ Available in Color
Disponibile in Color
Lieferbar in Color
Disponibile en Color
Disponibile en Color
Disponível em Color

Ⓘ Available in Ultralite
Disponibile in Ultralite
Lieferbar in Ultralite
Disponibile en Ultralite
Disponibile en Ultralite
Disponível em Ultralite

Ⓔ Available in Silky
Disponibile in Silky
Lieferbar in Silky
Disponibile en Silky
Disponibile en Silky
Disponível em Silky

REF.		PAGE	REF.		PAGE	REF.		PAGE
VAC44R	▲	198	VAC84	● ▲	201	VI12	▲	205
VAC45	▲	201	VAC85	● ▲	201	VI13	● ▲	205
VAC46	▲	198	VAC86	● ▲	201	VI14	●	206
VAC47	▲	199	VAC87	● ▲	201	VI15R	●	205
VAC48	● ▲ U S	201	VAC88	● ▲	201	VI16R	●	205
VAC49	● ▲	201	VAC89	▲	201	VI17	●	206
VAC5	▲	199	VAC8R	● ▲	198	VI18R	●	205
VAC50	● ▲	201	VAC91	■	202-247	VI19	●	205-248
VAC51	● ▲	201	VAL1	● ▲	203	VI1R	● ▲	205
VAC52	● ▲	201	VAL2	● ▲	203	VI2	●	206
VAC53	● ▲	201	VAR1	▲	203	VI23	▲	205
VAC54	● ▲	201	VAR1R	▲	203	VI2R	●	206
VAC55	● ▲	201	VAR2	▲	203	VI3	● U	205
VAC56	● ▲	199	VAR2R	▲	203	VI3R	● ▲ U	205
VAC57	● ▲	199	VAR3	▲	203	VI4	● ▲	206
VAC58	● ▲	199	VAR3R	▲	203	VI4R	● ▲	206
VAC6	▲	200	VAR4	▲	203	VI5	● ▲ U	205
VAC60	▲	198	VAR4R	▲	203	VI5R	● ▲ U	205
VAC60R	▲	198	VAR5	▲	203	VI6	●	205
VAC61	● ▲ U	199	VAV1	●	203	VI7	● ▲	206
VAC63	▲	199	VBH1R	●	204-248	VI7R	● ▲	206
VAC65	▲	198	VC1	▲	204	VI8	● ▲	205
VAC65R	● ▲	198	VC1R	● ▲	204	VI8R	● ▲	205
VAC66	● ▲	198	VEG1	▲	204	VI9	● ▲	205
VAC66R	● ▲	198	VG1	● U	205	VI9R	● ▲	205
VAC68	● ▲	201	VG2	● ▲	205	VK1	▲	206
VAC69	● ▲	201	VG3	● ▲	205	VK2	▲	206
VAC70	● ▲	201	VGD1	●	203-247	VL1	●	204
VAC71	● ▲	201	VI080	● ▲ U C S	205	VL1R	●	204
VAC72	● ▲	201	VI081	● ▲ U S	205	VL2	●	204
VAC73	● ▲	201	VI082	● ▲ U C S	206	VL2R	▲	204
VAC74	● ▲	201	VI083	● ▲ U	206	VL2RE	● ▲ U	113
VAC75	● ▲	201	VI084	● ▲ U C S	206	VL3	●	204
VAC76	● ▲	201	VI085	● ▲ U	206	VL3R	▲	204
VAC77	● ▲	201	VI086	● ▲ U C S	206	VL4	●	204
VAC78	● ▲	201	VI087	● ▲ U	206	VL4R	● ▲	204
VAC79	● ▲	201	VI088	● ▲	206	VL5E	● ▲	112-204
VAC8	● ▲	198	VI089	● ▲	206	VL5RE	● ▲	112-204
VAC80	● ▲	201	VI1	●	205	VLG1	▲	206
VAC81	● ▲	201	VI10	● ▲	206	VLK1R	● ▲	206
VAC82	● ▲	201	VI10R	● ▲	206	VLK2R	● ▲	206
VAC83	● ▲	201	VI11	▲	205	VN1	● ▲	205

● Brass
Ottone
Messing
Laiton
Latón
Latão

▲ Steel
Acciaio
Stahl
Acier
Acero
Aço

■ Nickel silver
Alpacca
Neusilber
Maillechort
Alpaca
Alpaca

◆ Iron
Ferro
Eisen
Fer
Hierro
Ferro

Ⓒ Available in Color
Disponibile in Color
Lieferbar in Color
Disponibile en Color
Disponibile en Color
Disponível em Color

Ⓒ Available in Ultralite
Disponibile in Ultralite
Lieferbar in Ultralite
Disponibile en Ultralite
Disponibile en Ultralite
Disponível em Ultralite

Ⓒ Available in Silky
Disponibile in Silky
Lieferbar in Silky
Disponibile en Silky
Disponibile en Silky
Disponível em Silky

REF.		PAGE	REF.		PAGE	REF.		PAGE
VN1R	● ▲	205	VYK6	● ▲	217	WE4	● ▲	209
VOG1	●	207	VYK7	●	216	WE4R	● ▲	209
VR1	●	204	VYK8	▲	216	WE5	● ▲	208
VRF3	● ▲	204	VYP5A	▲	216	WE5R	● ▲	208
VRF4	● ▲	204	VYP5B	▲	216	WE6	●	208
VS090V	● ▲	206	VYP5D	●	216	WE6R	●	208
VSR1R	● ▲ U	203	VYP6A	● ▲	217	WE7	●	209
VSR2	▲	203	VYP6B	▲	217	WE7R	●	209
VSR2R	● ▲ U	203	VYP6D	▲	217	WE8	●	209
VYA	●	216	W			WEB1	● ▲	208
VYA6	● ▲	217	WA1	● ▲ U	207	WEB2	▲	208
VYA7	●	216	WA1R	● ▲ U C S	207	WEB3	▲	208
VYA8	▲	216	WA2	● ▲ U	207	WEB4	▲	208
VYB	● ▲	216	WA2R	● ▲ U C	207	WEB5	● ▲	208
VYB6	● ▲	217	WA3	● ▲ U	207	WEI1	● ▲ ■ U	208
VYB7	●	216	WA3R	●	207	WEI2	● ▲ U	208
VYB8	▲	216	WA4	●	207	WEI3	● ▲	208
VYC	● ▲	216	WA4R	● ▲	207	WEI4	● ▲ ■ U	208
VYC6	●	217	WA6	● ▲	207	WEI5	● ▲ ■ U	208
VYC7	●	216	WA6R	● ▲	207	WEI8	▲	208
VYC8	●	216	WA7	●	207	WEI9	●	208
VYD	● ▲	216	WA7R	● ▲	207	WFE1	●	209
VYD6	●	217	WA8	●	207-248	WFE1R	●	209
VYD7	●	216	WC1	● ▲ U	210	WGU1	● ▲	207
VYD8	▲	216	WC2	● U	210	WH1	● U	211
VYE	● ▲	216	WC3	●	210	WJ1R	●	207-248
VYE6	● ▲	217	WE1	● ▲ U S	208	WK1	● ▲ U	210
VYE7	▲	216	WE12	●	209	WK10	● ▲	211
VYE8	●	216	WE12R	●	209	WK11	● ▲	211
VYF	● ▲	216	WE13	●	209	WK12	▲	211
VYF6	● ▲	217	WE13R	●	209	WK13	▲	211
VYF7	●	216	WE14	● U	209	WK14	▲	211
VYF8	▲	216	WE14R	●	209	WK15	● ▲	211
VYG	● ▲	216	WE15	●	209	WK16	● ▲	210
VYG6	●	217	WE16	●	208	WK17R	● ▲	211
VYG7	●	216	WE16R	●	208	WK18	● ▲	210
VYG8	▲	216	WE1R	● ▲ U	208	WK19	● ▲	210
VYH	● ▲	216	WE2	● ▲ U	209	WK1X	▲ U C S	210
VYH6	● ▲	217	WE2R	● ▲ U	209	WK2	▲	211
VYH7	●	216	WE3	● ▲ U	209	WK20	● ▲	210
VYH8	▲	216	WE3R	● ▲ U	209	WK21	● ▲	210
VYK	● ▲	216				WK22	● ▲	210

● Brass
Ottone
Messing
Laiton
Latón
Latão

▲ Steel
Acciaio
Stahl
Acier
Acero
Aço

■ Nickel silver
Alpacca
Neusilber
Maillechort
Alpaca
Alpaca

◆ Iron
Ferro
Eisen
Fer
Hierro
Ferro

Ⓒ Available in Color
Disponibile in Color
Lieferbar in Color
Disponibile en Color
Disponibile en Color
Disponível em Color

Ⓘ Available in Ultralite
Disponibile in Ultralite
Lieferbar in Ultralite
Disponibile en Ultralite
Disponibile en Ultralite
Disponível em Ultralite

Ⓔ Available in Silky
Disponibile in Silky
Lieferbar in Silky
Disponibile en Silky
Disponibile en Silky
Disponível em Silky

REF.		PAGE	REF.		PAGE	REF.		PAGE
WK25	● ▲	211	WK62R	▲	211	XBD1	●	255
WK25R	▲	211	WK63R	▲	210	XBD2	●	255
WK26	▲	210	WK68R	●	210	XBD3	●	255
WK27	▲	210	WK69	● ▲	210	XBD4	●	255
WK28	▲	210	WK6R	● ▲	211	XBD5	●	255
WK29	● ▲	210	WK7	● ▲	210	XBD6	●	255
WK2R	▲	211	WK70	●	211-248	XBD7	●	255
WK3	▲	93-210	WK71X	▲	211	XBRA1P	●	253
WK30	● ▲	210	WK8	● ▲	210	XBRY1	◆	253
WK31	● ▲	210	WK87X	▲	211	XBRY2	◆	253
WK32	▲	210	WK8R	● ▲	210	XBW1	◆	254
WK33	● ▲	210	WK9	● ▲	211	XBW1P	◆	254
WK34	● ▲	210	WK91R	▲	210	XBW2	◆	254
WK35	▲	210	WLC1	▲	211	XBW2P	◆	254
WK36	▲	210	WMS1	● ▲	211	XBW3	◆	254
WK37	▲	210	WMS2	▲	211	XBW3P	◆	254
WK38	▲	210	WR1	●	211	XBW4	◆	254
WK39	● ▲	210	WR2	▲	211	XBW4P	◆	254
WK4	▲	211	WR3	▲	211	XBW5	◆	255
WK40	● ▲	210	WR4	▲	211	XBW5P	◆	255
WK41R	● ▲	211	WR5R	▲	211	XC1	●	256
WK42R	● ▲	211	WS1	● ▲ U	209	XCCF10	●	256
WK43R	▲	211	WS2	● U	209	XCCF2	●	255
WK44R	▲	211	WS3	▲	209	XCCF3	●	255
WK45R	● ▲	211	WSA1	● ▲	207	XCCF6	●	256
WK45X	▲	211	WSD1	● ▲	212	XCCF7	●	256
WK46	▲	210	WSD1R	● ▲	212	XCCF8	●	256
WK47R	● ▲	211	WST1	● ▲	209	XCCF9	●	256
WK48	▲	210	WST2	● ▲	209	XF1P	◆	257
WK49R	▲	210	WST3	● ▲	209	XF2	◆	257
WK5	▲	210	WST4	●	209	XF2P	◆	257
WK50R	▲	210	WST5	●	209	XFB1	◆	256
WK51R	▲	210	WTR1R	▲	208	XFB1P	◆	257
WK52R	▲	211	WU1R	●	208-248	XFP1	◆	257
WK53R	● ▲	211				XG1P	◆	257
WK54R	▲	211				XG2P	◆	257
WK55	● ▲	210				XGR1	●	257
WK56R	●	211				XH1	◆	258
WK57	▲	210				XH2	◆	258
WK59R	▲	210				XH3	◆	258
WK6	▲	211				XIE3	◆	258
WK60R	● ▲	210				XIE4	◆	258

● Brass
Ottone
Messing
Laiton
Latón
Latão

▲ Steel
Acciaio
Stahl
Acier
Acero
Aço

■ Nickel silver
Alpaca
Neusilber
Maillechort
Alpaca
Alpaca

◆ Iron
Ferro
Eisen
Fer
Hierro
Ferro

Ⓒ Available in Color
Disponibile in Color
Lieferbar in Color
Disponibile en Color
Disponibile en Color
Disponível em Color

Ⓔ Available in Ultralite
Disponibile in Ultralite
Lieferbar in Ultralite
Disponibile en Ultralite
Disponibile en Ultralite
Disponível em Ultralite

Ⓕ Available in Silky
Disponibile in Silky
Lieferbar in Silky
Disponibile en Silky
Disponibile en Silky
Disponível em Silky

REF.		PAGE	REF.		PAGE	REF.		PAGE
XKV10	◆	259	XY7	◆	264	YA1E	●▲UC	212
XKV11	◆	259	XYAT11	◆	264	YA1ER	●▲U	212
XKV2	◆	259	XZ1A	◆	265	YA1R	●▲U	158-212
XKV6	◆	259	XZ1AP	◆	265	YA2	●▲U	217
XKV7	◆	259	XZ1B	◆	265	YA20	▲	213
XKV8	◆	259	XZ1BP	◆	265	YA20R	▲	213
XM1	◆	260	XZ1CP	◆	265	YA21	●	213
XM2	◆	260	XZ2A	◆	265	YA22	●	213
XMBL1P	●	260	XZ2AP	◆	265	YA226	●▲UC	214
XMBL2P	●	260	XZ2B	◆	265	YA227	●▲U	214
XMR1	◆	260	XZ2BP	◆	265	YA23	●▲U	213
XMR2P	●	260	XZ2CP	◆	265	YA24	●▲	213
XN1	◆	261	XZ3A	◆	266	YA25	●	213
XN1P	◆	261	XZ3AP	◆	266	YA26	●▲	213
XN3	◆	261	XZ3BP	◆	266	YA27R	●▲	212
XNA1	◆	260	XZ3CP	◆	266	YA29	●	212
XOC1	◆	261	XZ5A	◆	265	YA29R	●	212
XPDO1P	●	261	XZ6AP	◆	266	YA2R	●▲	217
XPK1	◆	262	XZAS1	◆	264	YA3	●▲	213
XPK2	◆	262	XZAS2	◆	264	YA30	●	213
XPZ1	◆	261	XZAS3	◆	264	YA30R	●▲	213
XPZ1P	●	261				YA31	●▲UCS	214
XPZ2	◆	261				YA31R	●▲U	214
XPZ2P	●	261				YA32	●▲	213
XRC1	◆	256				YA32R	●	213
XRC2	◆	256				YA33	●	215
XSAM3	●	262				YA33R	●	215
XSLH1P	◆	262				YA34	●	212
XSLH2P	◆	262				YA35	●▲	212
XTF1	◆	262				YA36	●U	212
XTF2	◆	262				YA38	●▲	212
XTF3	◆	262				YA39	●	215
XY1	◆	263				YA39P	●▲	215
XY10P	◆	263				YA3R	●▲	213
XY1P	◆	263				YA4	●▲U	213
XY2	◆	263				YA40P	●	215
XY2P	◆	263				YA41	●▲	214
XY3P	◆	263				YA42	●	214
XY4	◆	263				YA43	●▲	214
XY4P	◆	263				YA44	●▲	214
XY5P	◆	263				YA45	●	214
XY6P	◆	263				YA46	●▲	214

- Brass
Ottone
Messing
Laiton
Latón
Latão
- ▲ Steel
Acciaio
Stahl
Acier
Acero
Aço
- Nickel silver
Alpacca
Neusilber
Maillechort
Alpaca
Alpaca
- ◆ Iron
Ferro
Eisen
Fer
Hierro
Ferro
- Ⓒ Available in Color
Disponibile in Color
Lieferbar in Color
Disponibile en Color
Disponibile en Color
Disponível em Color
- Ⓘ Available in Ultralite
Disponibile in Ultralite
Lieferbar in Ultralite
Disponibile en Ultralite
Disponibile en Ultralite
Disponível em Ultralite
- Ⓔ Available in Silky
Disponibile in Silky
Lieferbar in Silky
Disponibile en Silky
Disponibile en Silky
Disponível em Silky

REF.		PAGE	REF.		PAGE	REF.		PAGE
YA47	●	214	YA74R	● ▲	215	YT12	● ▲	218
YA48	● ▲	214	YA7R	● ▲ U	215	YT12R	● ▲	218
YA49	● ▲	214	YA8	● ▲	213	YT13	● ▲	218
YA4R	● ▲ U	213	YA84	▲	212	YT13R	● ▲	218
YA5	● ▲ ■ U	212	YA84R	▲	212	YT14	● ▲	218
YA50	● ▲	214	YA85R	●	212	YT14R	● ▲	218
YA51	● ▲	214	YA86	▲	212	YT15	● ▲ U G	126
YA52	●	214	YA86R	●	212	YT15R	● ▲	126
YA53	● ▲	214	YA87	▲	214	YT15RX	▲	126
YA54	● ▲	214	YA88	▲	213	YT15X	● ▲ U	126
YA55	● ▲	214	YA89	● ▲	213	YT16	● ▲ G	126
YA56	● ▲	214	YA8E	▲	213	YT16X	● ▲	126
YA57	● ▲	214	YA8ER	● ▲	213	YT1R	● ▲	218
YA58	● ▲	214	YA8R	● ▲	213	YT2	● ▲	219
YA59	● ▲	214	YA9	●	34-212	YT2R	▲	219
YA5R	● ▲ U	212	YA90	●	214-248	YT3	▲	218
YA6	● ▲ U G	215	YA91	● ▲	213	YT3R	▲	218
YA60	● ▲	214	YA93	▲	214	YT4	● ▲	219
YA61	● ▲	214	YA94	●	214-248	YT4R	● ▲	219
YA62	● ▲	214	YA95R	●	214-248	YT5	●	219
YA63	● ▲	214	YA98R	●	214	YT5R	● ▲	219
YA64	● ▲	212	YA99R	●	214-248	YT6	● ▲	218
YA64R	● ▲	212	YAR1	●	218	YT6R	● ▲	218
YA65	●	213	YD1	● U	218	YT7	● ▲	218
YA65R	●	213	YD12	●	218	YT7R	● ▲	218
YA66	● ▲	213	YD13R	●	218-249	YT8	▲	218
YA66R	● ▲	213	YD14R	●	218-249	YT8R	▲	218
YA67	●	212	YD1R	● ▲	218	YT9	● ▲	219
YA68	● ▲	213	YD2	● ▲	218	YT9R	● ▲	219
YA68R	● ▲	213	YD2R	● ▲	218	YUH1R	▲	219
YA69	● ▲	213	YD3R	● ■	218-248	YUH2R	▲	219
YA69R	● ▲	213	YD4	● ▲ U	218	YYA	● ▲	217
YA6R	● ▲ U	215	YD4R	▲ U	218	YYA6	●	217
YA7	● ▲ U	215	YD5R	● U	218	YYA7	●	215
YA70	▲	217	YD6R	● ▲ ■ U	218-248	YYB	●	217
YA70R	▲	217	YD7R	● U	218-249	YYB6	● ▲	217
YA71	▲	217	YM18	▲	178	YYB7	●	215
YA71R	● ▲	217	YT1	● ▲	218	YYC	● ▲	217
YA72	● ▲	216	YT10	● ▲	219	YYC6	●	217
YA72R	▲	216	YT10R	● ▲	219	YYC7	●	215
YA73P	●	215	YT11	● ▲	219	YYD	●	217
YA74	● ▲	215	YT11R	● ▲	219	YYD6	● ▲	217

● Brass
Ottone
Messing
Laiton
Latón
Latão

▲ Steel
Acciaio
Stahl
Acier
Acero
Aço

■ Nickel silver
Alpaca
Neusilber
Maillechort
Alpaca
Alpaca

◆ Iron
Ferro
Eisen
Fer
Hierro
Ferro

Ⓒ Available in Color
Disponibile in Color
Lieferbar in Color
Disponibile en Color
Disponibile en Color
Disponível em Color

Ⓔ Available in Ultralite
Disponibile in Ultralite
Lieferbar in Ultralite
Disponibile en Ultralite
Disponibile en Ultralite
Disponível em Ultralite

Ⓕ Available in Silky
Disponibile in Silky
Lieferbar in Silky
Disponibile en Silky
Disponibile en Silky
Disponível em Silky

REF.		PAGE	REF.		PAGE	REF.		PAGE
YYD7	●	215	ZE10	● ▲	221	ZI3	● ▲	220
YYE	● ▲	217	ZE10R	● ▲	221	ZI3R	● ▲	220
YYE6	● ▲	217	ZE11	● ▲	220	ZI4	● ▲	220
YYE7	●	215	ZE11R	● ▲	220	ZI4R	● ▲	220
YYF	● ▲	217	ZE12	● ▲ U	221	ZI5	▲	220
YYF6	● ▲	217	ZE13	● ▲	221	ZI5R	●	220
YYF7	●	215	ZE13R	● ▲	221	ZN1	● ▲	221
YYG	● ▲	217	ZE14	● ▲	220	ZO1	●	222
YYG6	● ▲	217	ZE14R	● ▲	220			
YYG7	●	215	ZE15	▲	221			
YYH	● ▲	217	ZE16	▲	221			
YYH6	● ▲	217	ZE1R	● ▲ U	221			
YYH7	●	215	ZE1RX	▲ U C	220			
YYK	● ▲	217	ZE1X	▲ U C S	220			
YYK6	● ▲	217	ZE2	● ▲ U C	221			
YYK7	●	215	ZE3	▲	221			
YYP5A	●	217	ZE30	● ▲	221			
YYP5B	▲	217	ZE30R	● ▲	221			
YYP5D	▲	217	ZE34	▲	221			
YYP6A	▲	217	ZE34R	▲	221			
YYP6B	▲	217	ZE34RX	▲	220			
YYP6D	▲	217	ZE34X	▲	220			
YYP7R	●	215	ZE39	▲	221			
Z			ZE39R	▲	221			
ZA2R	● ▲	220	ZE39RX	▲	220			
ZD10P	● ▲	206	ZE39X	▲	220			
ZD11	▲	38-219	ZE3R	▲	221			
ZD11P	●	38-219	ZE4	● ▲	221			
ZD14RP	● ▲	219	ZE40X	● ▲	220			
ZD25	●	220-249	ZE42	▲	220			
ZD26R	●	220	ZE45	■	220			
ZD4	▲	219	ZE46	▲	220			
ZD4R	▲	219	ZE46R	▲	220			
ZD5	▲	219	ZE5	● ▲	221			
ZD5R	▲	219	ZE58	▲	221			
ZD6	● ▲	219	ZE5R	● ▲	221			
ZD7	● ▲	38-219	ZE7	● ▲	221			
ZD8	▲	219	ZH1R	●	222-249			
ZD9	● ▲	38-219	ZI1	● ▲	220			
ZD9P	● ▲	38-219	ZI1R	● ▲	220			
ZE1	● ▲ U C	221	ZI2	● ▲	220			
			ZI2R	● ▲	220			

● Brass
Ottone
Messing
Laiton
Latón
Latão

▲ Steel
Acciaio
Stahl
Acier
Acero
Aço

■ Nickel silver
Alpacca
Neusilber
Maillechort
Alpaca
Alpaca

◆ Iron
Ferro
Eisen
Fer
Hierro
Ferro

Ⓒ Available in Color
Disponibile in Color
Lieferbar in Color
Disponibile en Color
Disponível em Color

Ⓘ Available in Ultralite
Disponibile in Ultralite
Lieferbar in Ultralite
Disponibile en Ultralite
Disponível em Ultralite

Ⓔ Available in Silky
Disponibile in Silky
Lieferbar in Silky
Disponibile en Silky
Disponível em Silky



EN - All information and illustrations in this catalogue are for guidance only. Silca reserves the right to alter products designs, dimensions or info to improve the products quality.

The contents of this catalogue are fully protected by Copyright and may not be copied or reproduced in any form, without written permission from Silca. Any infringements will be dealt with under Italian law.

IT - Le illustrazioni e i dati tecnici dei prodotti contenuti nel catalogo debbono considerarsi indicativi.

Silca si riserva il diritto, ferme restando le caratteristiche essenziali dei prodotti, di apportare tutte le modifiche che ritiene necessarie e opportune al fine di migliorare la qualità dei prodotti.

Tutti i disegni e le fotografie sono di proprietà di Silca, ogni riproduzione anche parziale, senza autorizzazione scritta della Silca è vietata secondo termini di legge. Per qualsiasi controversia competenti sono gli Uffici Giudiziari dove ha sede l'Azienda, con espressa esclusione di qualsiasi altro foro.

DE - Die Abbildungen und technischen Daten des Katalogs sind nur zur Information.

Silca behält sich vor, etwaige Änderungen am Produkt, die zur Verbesserung desselben beitragen vorzunehmen.

Alle Zeichnungen und Fotos sind Besitz der Firma Silca, jede Reproduktion, auch teilweise, ist ohne schriftliche Erlaubnis der Firma Silca gesetzlich untersagt. Im Falle von Streitfragen ist der Gerichtshof des Firmensitzes zuständig; jeder andere Gerichtshof ist ausgeschlossen.

FR - Les illustrations et les caractéristiques techniques des produits présentés dans ce catalogue sont données à titre indicatif.

Bien que les caractéristiques essentielles des produits soient invariables, Silca se réserve le droit d'apporter toutes les modifications qu'elle retiendra nécessaires et opportunes afin d'améliorer la qualité de ses produits.

Tous les dessins et photos sont propriété Silca et toute reproduction, même partielle, sans l'autorisation écrite préalable de Silca est interdite conformément aux prescriptions légales. Tout litige est du ressort exclusif des Tribunaux de la circonscription où se trouve le Siège de la Société.

ES - Las ilustraciones y los datos técnicos de los productos en este catálogo son indicativos.

La Silca se reserva el derecho, quedando invariadas las características principales de los productos, de modificar todo lo que considere necesario y oportuno para mejorar la calidad de sus artículos. Todos los dibujos y las fotografías pertenecen a la Silca; según determina la Ley, se prohíbe toda reproducción aunque parcial, sin autorización por escrito de la Silca.

En caso de disputas la competencia es de las autoridades judiciales donde está domiciliada la firma, excluyendo cualquier otro foro.

PT - As ilustrações e as características técnicas dos produtos apresentados neste catálogo são facultados a título indicativo.

Mesmo que as características essenciais dos produtos sejam invariáveis, à Silca reserva-se o direito de modificar ser necessário e oportuno los productos, afim de melhorar a sua qualidade.

Todos os desenhos e fotos são propriedade da Silca, e é proibida a sua reprodução mesmo parcial sem a autorização escrita da Silca conforme as prescrições legais. Em caso de litígio fica desde já designado, excluindo qualquer outro, o Tribunal da comarca onde está registada a sede da Silca.



EN - In compliance with current regulations relating to industrial property, we hereby state that the trade-marks or trade names mentioned in our catalogue are the exclusive property of authorized manufacturers of locks and users. Said trade-marks or trade names are nominated only for the purposes of information so that any lock for which our keys are made can be rapidly identified. This catalogue is reserved exclusively for professional key cutters who use Silca products.

IT - In conformità alle disposizioni legali in vigore relative alle proprietà industriali, informiamo che i marchi o le denominazioni commerciali citate nel nostro catalogo sono di proprietà esclusiva dei fabbricanti di serrature e degli utilizzatori autorizzati. Questi marchi o denominazioni commerciali sono indicati a titolo di semplice informazione, con lo scopo di riconoscere velocemente a quali serrature le nostre chiavi sono destinate. Questo catalogo è esclusivamente riservato ai professionisti della riproduzione chiavi che utilizzano i prodotti Silca.

DE - Gemäß der derzeit geltenden Normen bezüglich des Industrieigentums teilen wir Ihnen mit, daß die im vorliegenden Katalog angeführten Markennamen oder Handelsmarken ausschließliches Eigentum der Schloßhersteller und zugelassenen Fachhändler sind. Diese Markenbezeichnungen oder Handelsmarken sind nur zur Information angeführt, mit dem Zweck, schnell erkennen zu können, zu welchem Schloß unsere Schlüssel gehören. Der vorliegende Katalog ist ausschließlich an Schlüsselkopier-Fachgeschäfte, die Silca Produkte benutzen, gerichtet.

FR - Conformément aux lois en vigueur concernant la propriété industrielle, nous vous informons que les marques et appellations commerciales citées dans notre catalogue appartiennent exclusivement aux fabricants de serrures et aux utilisateurs autorisés. Ces marques ou appellations commerciales sont indiquées à titre d'information pure et simple pour vous permettre de déterminer rapidement les serrures auxquelles nos clés sont destinées. Ce catalogue est réservé exclusivement aux professionnels du taillage de clés qui utilisent les produits Silca.

ES - En conformidad con las vigentes disposiciones de ley sobre propiedad industrial, las marcas y denominaciones comerciales citadas en nuestro catálogo se declaran de propiedad exclusiva de los fabricantes de cerraduras y los utilizadores autorizados. Dichas marcas o denominaciones comerciales se citan por simple información, al objeto de hacer comprender sin dificultad a qué cerraduras van destinadas nuestras llaves. Este catálogo está reservado exclusivamente a los profesionales de la reproducción de llaves que utilizan los productos Silca.

PT - Em conformidade com as disposições legais em vigor relativas à propriedade industrial, informamos que as marcas ou as denominações comerciais citadas no nosso catálogo são propriedade exclusiva dos fabricantes de fechaduras e dos utilizadores autorizados. Estas marcas ou denominações comerciais são indicadas só a nível de informação, a fim de reconhecer rapidamente a quais fechaduras se destinam as nossas chaves. Este catálogo é reservado exclusivamente aos profissionais da reprodução de chaves que utilizam os produtos Silca.

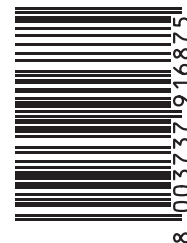

P1BA
Printed in Italy 09/2018

**ITALY AND OTHER COUNTRIES
SILCA S.p.A.**

Via Podgora, 20 (Z.I.)
31029 VITTORIO VENETO (TV)
Tel. +39 0438 9136
Fax +39 0438 913800
E-mail: silca@silca.it
www.silca.biz - www.silca.it

**FRANCE
SILCA S.A.S.**

12, Rue de Rouen
Z.I. Limay-Porcheville
78440 PORCHEVILLE
Phone: +33 1 30983500
Fax +33 1 30983501
E-mail: info@silca.fr
www.silca.fr

**GERMANY
SILCA GmbH**

Siemensstrasse, 33
42551 VELBERT
Phone: +49 2051 2710
Fax +49 2051 271172
E-mail: info@silca.de
www.silca.de

**BENELUX
H. CILLEKENS & B.V.**

Metaalweg, 4
6045 JB ROERMOND
Phone: +31 475 325147
Fax +31 475 323640
E-mail: info@hcillekens.nl
www.hcillekens.nl

**UNITED KINGDOM
SILCA**

Unit 6 Lloyds Court
Manor Royal
CRAWLEY RH10 9QU
Phone: +44 1293 531134
Fax +44 1293 531108
E-mail: sales@silcald.co.uk
www.silcald.co.uk

**UNITED KINGDOM
ADVANCED DIAGNOSTICS Ltd.**

Eastboro Fields
Hemdale Business Park
CV11 6GL NUNEATON
Phone: +44 2476 347000
Fax + 44 2476 347100
E-mail: sales@advanced-diagnostics.com
www.advanced-diagnostics.com

**SPAIN
SILCA KEY SYSTEMS S.A.**

C/Santander 73A
08020 BARCELONA
Phone: +34 93 4981400
Fax +34 93 2788004
E-mail: silca@silca.es
www.silca.es

Copyright by Silca S.p.A. 2018



dormakaba Group



NETWORK WITH US